



TECHNICAL SPECIFICATION

**Terrestrial Trunked Radio (TETRA);
Voice plus Data (V+D);
Part 3: Interworking at the Inter-System Interface (ISI);
Sub-part 13: Transport layer independent
Additional Network Feature Group Call (ANF-ISIGC)**

Reference

DTS/TCCE-03241

Keywords

management, mobility, TETRA

ETSI

650 Route des Lucioles
F-06921 Sophia Antipolis Cedex - FRANCE

Tel.: +33 4 92 94 42 00 Fax: +33 4 93 65 47 16

Siret N° 348 623 562 00017 - NAF 742 C
Association à but non lucratif enregistrée à la
Sous-Préfecture de Grasse (06) N° 7803/88

Important notice

The present document can be downloaded from:

<http://www.etsi.org/standards-search>

The present document may be made available in electronic versions and/or in print. The content of any electronic and/or print versions of the present document shall not be modified without the prior written authorization of ETSI. In case of any existing or perceived difference in contents between such versions and/or in print, the only prevailing document is the print of the Portable Document Format (PDF) version kept on a specific network drive within ETSI Secretariat.

Users of the present document should be aware that the document may be subject to revision or change of status.

Information on the current status of this and other ETSI documents is available at

<https://portal.etsi.org/TB/ETSIDeliverableStatus.aspx>

If you find errors in the present document, please send your comment to one of the following services:

<https://portal.etsi.org/People/CommiteeSupportStaff.aspx>

Copyright Notification

No part may be reproduced or utilized in any form or by any means, electronic or mechanical, including photocopying and microfilm except as authorized by written permission of ETSI.

The content of the PDF version shall not be modified without the written authorization of ETSI.

The copyright and the foregoing restriction extend to reproduction in all media.

© ETSI 2018.

All rights reserved.

DECT™, **PLUGTESTS™**, **UMTS™** and the ETSI logo are trademarks of ETSI registered for the benefit of its Members.

3GPP™ and **LTE™** are trademarks of ETSI registered for the benefit of its Members and of the 3GPP Organizational Partners.

oneM2M logo is protected for the benefit of its Members.

GSM® and the GSM logo are trademarks registered and owned by the GSM Association.

Contents

Intellectual Property Rights	9
Foreword	9
Modal verbs terminology	10
1 Scope	11
2 References	12
2.1 Normative references	12
2.2 Informative references	13
3 Definitions and abbreviations	13
3.1 Definitions	13
3.2 Abbreviations	14
4 ANF-ISIGC stage 1 specification	15
4.1 Description	15
4.1.1 General description	15
4.1.2 Qualifications on applicability to TETRA basic services	16
4.2 Procedures	16
4.2.1 Provision/withdrawal	16
4.2.2 Normal procedures	16
4.2.2.1 Activation/deactivation/registration/interrogation	16
4.2.2.2 Invocation and operation	16
4.2.2.3 ANF-ISIGC - the service provider	16
4.2.2.3.1 General	16
4.2.2.3.2 Establishing the group call at the originating and controlling TETRA SwMI	17
4.2.2.3.3 Establishing the group call at a participating TETRA SwMI	19
4.2.2.3.4 Delaying the group call	20
4.2.2.3.5 Control of call time-out timers	20
4.2.2.3.6 Acknowledged group call procedures	21
4.2.2.3.7 Colliding call setup signalling	21
4.2.2.3.8 Joining of calls	22
4.2.2.3.9 Maintenance of the group call	22
4.2.2.3.10 Termination of the group call	24
4.2.3 Exceptional procedures	25
4.2.3.1 Activation/deactivation/registration/interrogation	25
4.2.3.2 Invocation and operation	25
4.3 Interaction with TETRA supplementary services and other TETRA ANFs	25
4.3.1 General	25
4.3.2 Calling Line Identification Presentation (SS-CLIP)	25
4.3.3 Connected Line Identification Presentation (SS-COLP)	25
4.3.4 Calling/Connected Line Identification Restriction (SS-CLIR)	25
4.3.5 Call Report (SS-CR)	25
4.3.6 Talking Party Identification (SS-TPI)	26
4.3.7 Call Forwarding Unconditional (SS-CFU)	26
4.3.8 Call Forwarding on Busy (SS-CFB)	26
4.3.9 Call Forwarding on No Reply (SS-CFNRY)	26
4.3.10 Call Forwarding on Not Reachable (SS-CFNRC)	26
4.3.11 List Search Call (SS-LSC)	26
4.3.12 Call Authorized by Dispatcher (SS-CAD)	26
4.3.13 Short Number Addressing (SS-SNA)	26
4.3.14 Area Selection (SS-AS)	26
4.3.15 Access Priority (SS-AP)	26
4.3.16 Priority Call (SS-PC)	27
4.3.17 Call Waiting (SS-CW)	27
4.3.18 Call Hold (SS-HOLD)	27
4.3.19 Call Completion to Busy Subscriber (SS-CCBS)	27
4.3.20 Late Entry (SS-LE)	27

4.3.21	Pre-emptive Priority Call (SS-PPC).....	27
4.3.22	Include Call (SS-IC)	27
4.3.23	Barring of Outgoing Calls (SS-BOC)	27
4.3.24	Barring of Incoming Calls (SS-BIC).....	27
4.3.25	Discreet Listening (SS-DL)	28
4.3.26	Ambience Listening (SS-AL)	28
4.3.27	Dynamic Group Number Assignment (SS-DGNA).....	28
4.3.28	Call Completion on No Reply (SS-CCNR).....	28
4.3.29	Call Retention (SS-CRT)	28
4.3.30	Additional Network Features - Inter-System Interface Individual Call (ANF-ISIIC).....	28
4.3.31	ISI Short Data (ANF-ISISD).....	28
4.3.32	ISI Mobility Management (ANF-ISIMM)	28
5	ANF-ISIGC stage 2 specification.....	28
5.1	Functional model.....	28
5.1.1	Functional model description.....	28
5.1.2	Description of functional entities	30
5.1.2.1	ISI group call originating entity, FE1	30
5.1.2.2	Originating SwMI CC application functional entity, FE1'	30
5.1.2.3	ISI group home entity/group call controlling entity, FE2.....	30
5.1.2.4	Group home SwMI/Controlling SwMI CC application functional entity, FE2'	31
5.1.2.5	ISI group call participating entity, FE3	31
5.1.2.6	Participating SwMI CC application functional entity, FE3'	32
5.2	Information flow.....	32
5.2.1	Information flow diagrams.....	32
5.2.1.1	General Information about Information Flow Diagrams.....	32
5.2.1.2	Successful group call set-up over ISI using ANF-ISIGC	33
5.2.1.3	Acknowledged group call set-up over ISI using ANF-ISIGC	41
5.2.1.4	Partial group call set-up over ISI using ANF-ISIGC.....	42
5.2.1.5	Delay of group call set-up over ISI using ANF-ISIGC	45
5.2.1.6	Interaction with an active group call	48
5.2.1.7	Unsuccessful group call set-up over ISI using ANF-ISIGC.....	50
5.2.1.8	Call Maintenance procedures - Request to transmit	52
5.2.1.9	Call maintenance procedures - Cease transmission.....	58
5.2.1.10	Call Maintenance procedures - Withdraw/Continue from an active group call	62
5.2.1.11	Call Maintenance procedures - Information flow to participating SwMI(s)	64
5.2.1.12	Call Disconnection procedures - Controlling SwMI disconnects the call	65
5.2.1.13	Call Disconnection procedures - Participating SwMI disconnects from the call	65
5.2.1.14	Call Disconnection procedures - Call Owner disconnects the whole call	67
5.2.2	Definitions of Information Flows.....	68
5.2.2.1	General about Information Flows.....	68
5.2.2.2	ISI_CONNECT	68
5.2.2.3	ISI_DISCONNECT.....	68
5.2.2.4	ISI_INFO.....	69
5.2.2.5	ISI_INTERACT	70
5.2.2.6	ISI_ORIGINATING SETUP	70
5.2.2.7	ISI_POLL.....	71
5.2.2.8	ISI_REJECT.....	72
5.2.2.9	ISI_RELEASE	72
5.2.2.10	ISI_REROUTE.....	73
5.2.2.11	ISI_RESOURCE	73
5.2.2.12	ISI_SETUP.....	73
5.2.2.13	ISI_TX-CEASED.....	74
5.2.2.14	ISI_TX-CONTINUE.....	75
5.2.2.15	ISI_TX-DEMAND.....	75
5.2.2.16	ISI_TX-GRANTED	76
5.2.2.17	ISI_TX-INTERRUPT	76
5.2.2.18	ISI_TX-WAIT.....	76
5.3	Functional Entity Actions (FEAs)	77
5.3.1	Functional Entity Actions of FE1	77
5.3.2	Functional Entity Actions of FE1'	78
5.3.3	Functional Entity Actions of FE2	78

5.3.4	Functional entity actions of FE2'	81
5.3.5	Functional Entity Action of FE3	82
5.3.6	Functional entity actions of FE3'	84
6	ANF-ISIGC stage 3 specification	85
6.1	ANF-ISIGC description	85
6.2	ANF-ISIGC operational requirements	85
6.3	ANF-ISIGC coding requirements	85
6.3.1	TETRA ANF-ISIGC PDUs	85
6.3.1.1	General Information about PDU Descriptions	85
6.3.1.2	ISI-ORIGINATING SETUP PDU sent by the originating SwMI - used to forward a call set-up request	86
6.3.1.3	ISI-SETUP INITIATE PDU sent by the controlling SwMI - used for setting up a group call	87
6.3.1.4	ISI-INFO PDU	88
6.3.1.5	ISI-SETUP ACKNOWLEDGE PDU sent by the originating or a participating SwMI - used as a call set-up response	89
6.3.1.6	ISI-DELAY PDU sent by the originating or a participating SwMI - used to delay call set-up	91
6.3.1.7	ISI-CONNECT PDU sent by the controlling SwMI - used for connecting the call	91
6.3.1.8	ISI-POLL USER PDU sent by the controlling SwMI - used for polling	93
6.3.1.9	ISI-POLL RESPONSE PDU sent by a participating SwMI - used as a polling response	93
6.3.1.10	ISI-TX DEMAND PDU sent by a participating SwMI - used to request transmission permission	94
6.3.1.11	ISI-RESOURCE PDU sent by the controlling SwMI - used to request reservation of resources	94
6.3.1.12	ISI-RESOURCE RESPONSE PDU sent by a participating SwMI - used as a resource response	95
6.3.1.13	ISI-TX CEASED PDU sent by a participating SwMI and a controlling SwMI - used to request/inform cease of transmission	95
6.3.1.14	ISI-TX GRANTED PDU sent by the controlling SwMI - used to inform grant of transmission	96
6.3.1.15	TETRA PDU sent by the controlling SwMI - used to inform interruption of transmission	97
6.3.1.16	ISI-TX CONTINUE PDU sent by a participating SwMI - used to inform of continuation in an active group call	97
6.3.1.17	ISI-TX WAIT PDU sent by a participating SwMI - used to inform of withdrawal from an active group call	98
6.3.1.18	ISI-REJECT PDU	98
6.3.1.19	ISI-DISCONNECT PDU sent by the originating SwMI or a participating SwMI - used to disconnect from the call	98
6.3.1.20	ISI-RELEASE PDU sent by the controlling SwMI	99
6.3.1.21	ISI-REROUTE PDU sent by the group home SwMI or the linking controlling SwMI - used to re-route the call	99
6.3.2	TETRA PDU information element coding	100
6.3.2.1	General about the TETRA PDU Information Encoding	100
6.3.2.2	Additional information to existing information element at the ISI	100
6.3.2.2.1	Call status	100
6.3.2.2.2	Call time-out, set-up phase	100
6.3.2.2.3	Call time-out	101
6.3.2.2.4	Disconnect cause information element	101
6.3.2.2.5	Temporary group basic migration profile	102
6.3.2.2.6	PDU type	103
6.3.2.2.7	SS-migration profile	103
6.3.2.3	New information elements used at the ISI	104
6.3.2.3.1	Call amalgamation	104
6.3.2.3.2	Call diverted to dispatcher	104
6.3.2.3.3	Call owner request	104
6.3.2.3.4	Call resource time-out	104
6.3.2.3.5	Calling group identifier	105
6.3.2.3.6	Calling party information present	105
6.3.2.3.7	Connected party SSI and extension	105
6.3.2.3.8	Controlling/originating/participating SwMI MNI	105
6.3.2.3.9	Critical connected party/requesting party/transmitting party SSI and extension	105
6.3.2.3.10	Critical user list	105
6.3.2.3.11	Disconnect type	106
6.3.2.3.12	Dispatcher acceptance	106
6.3.2.3.13	External group member identity	106
6.3.2.3.14	External subscriber number digits	106

6.3.2.3.15	External subscriber number length	107
6.3.2.3.16	External subscriber number parameters	107
6.3.2.3.17	Group attachment indicator	107
6.3.2.3.18	Group call SwMI type	107
6.3.2.3.19	Group information	108
6.3.2.3.20	ISI-INFO type	108
6.3.2.3.21	Linking group type identifier	108
6.3.2.3.22	Numbering plan identifier	109
6.3.2.3.23	Poll request type	109
6.3.2.3.24	Poll result identifier	109
6.3.2.3.25	Reject cause information element	109
6.3.2.3.26	Resource allocation	110
6.3.2.3.27	Resource indicator	111
6.3.2.3.28	Screening indicator	111
6.3.2.3.29	Security level at air interface	111
6.3.2.3.30	Setup response time-out	111
6.3.2.3.31	Set-up type	112
6.3.2.3.32	Speech service chosen/requested/used	112
6.3.2.3.33	Speech services supported	112
6.3.2.3.34	SS-CLIR invoked for calling/transmitting/restoring/connected party	113
6.3.2.3.35	Temporary group member indication	113
6.3.2.3.36	Transmission Ceased	113
6.3.2.3.37	Type of number	114
6.4	ANF-ISIGC state definitions	114
6.4.1	States at the originating SwMI	114
6.4.1.1	IDLE	114
6.4.1.2	FORWARD CALL	114
6.4.1.3	WAIT CONNECT	115
6.4.1.4	DELAY GROUP CALL	115
6.4.1.5	CALL DISCONNECT	116
6.4.1.6	CALL RELEASE	116
6.4.2	States at the controlling SwMI	116
6.4.2.1	IDLE	116
6.4.2.2	GROUP CALL INITIATE	117
6.4.2.3	DELAY GROUP CALL	117
6.4.2.4	ACTIVE	117
6.4.3	States at the participating SwMI	118
6.4.3.1	IDLE	118
6.4.3.2	WAIT CONNECT	119
6.4.3.3	DELAY ENTRY	119
6.4.3.4	DELAY GROUP CALL	119
6.4.3.5	ACTIVE	120
6.4.3.6	CALL DISCONNECT	120
6.4.3.7	CALL RELEASE	121
6.5	ANF-ISIGC signalling procedures	121
6.5.1	General about ANF-ISIGC Signalling Procedures	121
6.5.2	Call set-up procedures	121
6.5.2.1	Forward set-up request	121
6.5.2.2	Group linking	121
6.5.2.3	Call request in the (Linking) Controlling SwMI	121
6.5.2.4	Call confirmation and call characteristics notification by the originating and participating SwMI(s)	122
6.5.2.5	Call confirmation indication and call connected by the controlling SwMI	123
6.5.2.6	Delay of call set-up	123
6.5.2.7	Failure of call establishment	123
6.5.2.8	Multiple calling parties	124
6.5.2.8.1	General about Multiple Calling parties	124
6.5.2.8.2	A new calling party appears at a SwMI not currently in the group call	124
6.5.2.8.3	A new, compatible, calling party appears at a SwMI where a group call is active	124
6.5.2.8.4	A new, compatible, calling party appears at an OSwMI where a group call is still in the setup phase	124

6.5.2.8.5	A new, compatible, calling party appears at an PSwMI where a group call is still in the setup phase	124
6.5.2.8.6	A new calling party requesting an emergency call appears at a SwMI where the existing call is not at an emergency priority	125
6.5.2.8.7	A new, non-compatible, calling party appears at a SwMI where a group call is already active	125
6.5.2.8.8	A new calling party appears at a CSwMI that only supports a single ISI-ORIGINATING SETUP PDU	125
6.5.2.8.9	The sending of subsequent ISI-ORIGINATING SETUP PDUs to the CSwMI	125
6.5.2.9	Security level.....	126
6.5.3	Acknowledge group call	126
6.5.4	Call maintenance procedures	126
6.5.4.1	General about Call maintenance procedures	126
6.5.4.2	Transmission control procedures.....	126
6.5.4.3	Call modification and/or continuation.....	128
6.5.4.4	DTMF procedures	128
6.5.5	Call disconnection procedures	128
6.6	Protocol interaction between ANF-ISIGC and supplementary services and other ANFs	129
6.6.1	Call Forwarding Unconditional (SS-CFU)	129
6.6.2	Call Authorized by Dispatcher (SS-CAD).....	129
6.6.3	Area Selection (SS-AS) and selected area number	130
6.6.4	Priority Call (SS-PC)	130
6.6.5	Pre-emptive Priority Call (SS-PPC).....	130
6.6.6	Include Call (SS-IC)	130
6.6.7	Call Retention (SS-CRT)	131
6.6.8	Interactions with other supplementary services	131
6.7	ANF-ISIGC parameter values (timers).....	131

Annex A (normative): Specification and Description Language (SDL) representation of procedures..... 132

A.1	General	132
A.2	SDL representation of an ANF-ISIGC entity at FE1.....	132
A.3	SDL representation of an ANF-ISIGC entity at FE2.....	135
A.4	SDL representation of an ANF-ISIGC entity at FE3.....	139

Annex B (normative): Stage 2 description of the interactions between ANF-ISIGC and SS-CAD when invoked for the called group..... 143

B.1	Information flow diagrams	143
B.1.1	Group call set-up when SS-CAD is invoked for called group.....	143
B.2	Definition of information flows.....	154
B.2.1	General	154
B.2.2	ISI_THROUGH CONNECT	154
B.3	Functional Entity Actions (FEAs)	154
B.3.1	General	154
B.3.2	Functional entity actions of FE1	154
B.3.3	Functional entity actions of FE1'	155
B.3.4	Functional entity actions of FE2	155
B.3.5	Functional entity actions of FE2'	155
B.3.6	Functional entity actions of FE3	156
B.3.7	Functional entity actions of FE3'	156

Annex C (informative): Signalling Diagram Examples..... 157

C.1	Call Setup	157
C.1.1	Call Setup General.....	157
C.1.2	Single calling party, no queuing for resources	157
C.1.3	Single calling party, some queuing for resources	158
C.1.4	Single calling party, some queuing for resources, different connect strategy.....	160
C.1.5	Single calling party, some queuing for resources, showing multiple releasing	162

C.1.6	Multiple calling parties, a new calling party is on a SwMI not currently in the call	164
C.1.7	Multiple calling parties, the new setup from the second OSwMI is received while the CSwMI is delaying the call.....	165
C.1.8	Multiple calling parties, the new setup from the second OSwMI is received while the CSwMI is activating the call.....	167
C.1.9	Multiple calling parties during delayed setup, a new calling party is on a SwMI not currently in the call	169
C.1.10	Multiple calling parties, a new calling party on a SwMI not currently in the call is granted transmission	170
C.1.11	Multiple calling parties, the new calling party is granted transmission	172
C.1.12	Multiple calling parties, a PSwMI transitions back into a OSwMI	174
C.1.13	Multiple calling parties and no PSwMI	175
C.1.14	Multiple calling parties at the same SwMI	176
C.1.15	Successful Group Call Establishment. The CSwMI does not accept more than one calling party	177
C.1.16	Late Entry	178
C.1.17	A SwMI joins with a Connected Call	178
C.1.18	An emergency priority call to a group that is already in an active, non-emergency, call	179
C.1.19	A call collision at startup	180
C.1.20	Partial successful group call establishment, call is not accepted by a PSwMI	181
C.1.21	Unsuccessful group call establishment rejected by an OswMI.....	181
C.1.22	Unsuccessful group call establishment, the CSwMI cannot accept some parameters, such as <i>resource allocation</i> , in the ISI SETUP ACKNOWLEDGE PDU from an OswMI.....	182
C.1.23	Unsuccessful Group Call Establishment, OSwMI or Party times out	183
C.1.24	Unsuccessful group call establishment rejected by the CSwMI	183
C.2	Call maintenance	185
C.3	Call termination	187
C.3.1	The release of a SwMI from a call.....	187
C.3.2	Call disconnection, as a result of a PSwMI disconnecting	187
C.3.3	Call disconnection by the CSwMI.....	188
Annex D (informative):	Bibliography	189
Annex E (informative):	Change Requests	190
History		191

Intellectual Property Rights

Essential patents

IPRs essential or potentially essential to normative deliverables may have been declared to ETSI. The information pertaining to these essential IPRs, if any, is publicly available for **ETSI members and non-members**, and can be found in ETSI SR 000 314: "*Intellectual Property Rights (IPRs); Essential, or potentially Essential, IPRs notified to ETSI in respect of ETSI standards*", which is available from the ETSI Secretariat. Latest updates are available on the ETSI Web server (<https://ipr.etsi.org/>).

Pursuant to the ETSI IPR Policy, no investigation, including IPR searches, has been carried out by ETSI. No guarantee can be given as to the existence of other IPRs not referenced in ETSI SR 000 314 (or the updates on the ETSI Web server) which are, or may be, or may become, essential to the present document.

Trademarks

The present document may include trademarks and/or tradenames which are asserted and/or registered by their owners. ETSI claims no ownership of these except for any which are indicated as being the property of ETSI, and conveys no right to use or reproduce any trademark and/or tradename. Mention of those trademarks in the present document does not constitute an endorsement by ETSI of products, services or organizations associated with those trademarks.

Foreword

This Technical Specification (TS) has been produced by ETSI Technical Committee TETRA and Critical Communications Evolution (TCCE).

The present document is part 3, sub-part 13 of a multi-part deliverable covering the Terrestrial Trunked Radio (TETRA); Voice plus Data (V+D), as identified below:

Part 1: "General network design";

Part 2: "Air Interface (AI)";

Part 3: "Interworking at the Inter-System Interface (ISI)":

Sub-part 1: "General design";

Sub-part 2: "Additional Network Feature Individual Call (ANF-ISIIC)";

Sub-part 3: "Additional Network Feature Group Call (ANF-ISIGC)";

Sub-part 4: "Additional Network Feature Short Data Service (ANF-ISISDS)";

Sub-part 5: "Additional Network Feature for Mobility Management (ANF-ISIMM)";

Sub-part 6: "Speech format implementation for circuit mode transmission";

Sub-part 7: "Speech Format Implementation for Packet Mode Transmission";

Sub-part 8: "Generic Speech Format Implementation";

Sub-part 9: "Transport layer independent, General design";

Sub-part 10: "General design, PSS1 over E.1";

Sub-part 11: "General design, SIP/IP";

Sub-part 12: "Transport layer independent Additional Network Feature Individual Call (ANF-ISIIC)";

Sub-part 13: "Transport layer independent Additional Network Feature Group Call (ANF-ISIGC)";

Sub-part 14: "Transport layer independent Additional Network Feature Short Data Service (ANF-ISISDS)";

Sub-part 15: Transport layer independent Additional Network Feature, Mobility Management (ANF-ISIMM);

Part 4: "Gateways basic operation";

Part 5: "Peripheral Equipment Interface (PEI)";

Part 7: "Security";

Part 9: "General requirements for supplementary services";

Part 10: "Supplementary services stage 1";

Part 11: "Supplementary services stage 2";

Part 12: "Supplementary services stage 3";

Part 13: "SDL model of the Air Interface (AI)";

Part 14: "Protocol Implementation Conformance Statement (PICS) proforma specification";

Part 15: "TETRA frequency bands, duplex spacings and channel numbering";

Part 16: "Network Performance Metrics";

Part 17: "TETRA V+D and DMO specifications";

Part 18: "Air interface optimized applications";

NOTE 1: Part 3, sub-parts 6 and 7 (Speech format implementation), part 4, sub-part 3 (Data networks gateway), part 10, sub-part 15 (Transfer of control), part 13 (SDL) and part 14 (PICS) of this multi-part deliverable are in status "historical" and are not maintained.

NOTE 2: Some parts are also published as Technical Specifications such as ETSI TS 100 392-2 and those may be the latest version of the document.

The current document is based on ETSI EN 300 392-3-3 [i.6]. The main changes are:

- Removal of any reference to the bearer protocol
- Removal of group call restoration
- Clean up of stage 2 descriptions

For all subparts in the TETRA specification ETSI EN 300 392-3, "Interworking at the Inter-System Interface (ISI)" the terms ISI and TETRA ISI are equivalent.

Modal verbs terminology

In the present document "**shall**", "**shall not**", "**should**", "**should not**", "**may**", "**need not**", "**will**", "**will not**", "**can**" and "**cannot**" are to be interpreted as described in clause 3.2 of the [ETSI Drafting Rules](#) (Verbal forms for the expression of provisions).

"**must**" and "**must not**" are **NOT** allowed in ETSI deliverables except when used in direct citation.

1 Scope

The present document defines the group call communication of interworking at the Inter-System Interface (ISI) for Terrestrial Trunked Radio system (TETRA) supporting Voice plus Data (V+D).

The TETRA V+D interworking - basic operation part defines the interworking between TETRA networks over the corresponding interface: the Inter-System Interface (ISI). It comprises the following sub-parts:

- Transport Layer Independent Specification ISI general design [2];
- General Design, PSS1 over E.1 [i.7];
- General Design, SIP/IP [i.8];
- Transport Layer Independent Additional Network Feature - ISI Individual Call (ANF-ISIIC) [3];
- Transport Layer Independent Additional Network Feature Group Call (ANF-ISIGC) (the present document);
- Transport Layer Independent Additional Network Feature Short Data service (ANF-ISISD) [i.9];
- Transport Layer Independent Additional Network Feature Mobility Management (ANF-ISIMM) [4];
- Generic Speech Format Implementation [i.10].

The present document is the ANF-ISIGC sub-part 3-13.

In analogy with Recommendation ITU-T I.130 [i.3], the stage one, stage two and stage three of the three level structure is used to describe the TETRA Inter-System Interface services as provided by European Private or Public Trunked Radio System operators:

- Stage 1, is an overall service description, from the service subscriber's and user's standpoint;
- Stage 2, identifies the functional capabilities and information flows needed to support the services described in stage 1; and

NOTE: The information flows in stage 2 have been drawn as Message Sequence Charts (MSC).

- Stage 3, defines the signalling system protocols and functions needed to implement the services described in stage 1.

The present document details the Interworking Basic Operation of the Terrestrial Trunked Radio system (TETRA). Specifically the present document details the stage 1 aspects (overall service description) of the ANF-ISIGC as seen from the TETRA Switching and Maintenance Infrastructure point of view at the Inter-System Interface (ISI). It details the stage 2 aspects (functional partitioning) of ANF-ISIGC which includes the identification of the functional entities and the flows between them, and finally it details the stage 3 signalling protocols for the ANF-ISIGC services, i.e. the protocols at the relevant reference points between the functional entities defined in stage 2.

The ANF-ISIGC service specifies:

- TETRA Group Call Clear Speech over the ISI, acknowledged and unacknowledged;
- TETRA Group Call End-to-End Encrypted Speech over the ISI;
- TETRA Group Call Circuit Mode one slot data over the ISI;
- TETRA Group Call Circuit Mode one slot End-to-End Encrypted data over the ISI;
- TETRA Group Call Circuit Mode $N \times 2,4$ kbit/s, $N \times 4,8$ kbit/s or $N \times 7,2$ kbit/s data, with $N = 2, 3$ or 4 ;
- TETRA Group Call Circuit Mode $N \times 2,4$ kbit/s $N \times 4,8$ kbit/s or $N \times 7,2$ kbit/s End-to-End Encrypted data, with $N = 2, 3$ or 4 .

2 References

2.1 Normative references

References are either specific (identified by date of publication and/or edition number or version number) or non-specific. For specific references, only the cited version applies. For non-specific references, the latest version of the referenced document (including any amendments) applies.

Referenced documents which are not found to be publicly available in the expected location might be found at <https://docbox.etsi.org/Reference/>.

NOTE: While any hyperlinks included in this clause were valid at the time of publication, ETSI cannot guarantee their long term validity.

The following referenced documents are necessary for the application of the present document.

- [1] ETSI EN 300 392-2: "Terrestrial Trunked Radio (TETRA); Voice plus Data (V+D); Part 2: Air Interface (AI)".
- [2] ETSI TS 100 392-3-9: "Terrestrial Trunked Radio (TETRA); Voice plus Data (V+D); Part 3: Interworking at the Inter-System Interface (ISI); Sub-part 9: Transport layer independent, General design".
- [3] ETSI TS 100 392-3-12: "Terrestrial Trunked Radio (TETRA); Voice plus Data (V+D); Part 3: Interworking at the Inter-System Interface (ISI); Sub-part 12: Transport Layer Independent Additional Network Feature Individual Call (ANF-ISIIC)".
- [4] ETSI TS 100 392-3-15: "Terrestrial Trunked Radio (TETRA); Voice plus Data (V+D); Part 3: Interworking at the Inter-System Interface (ISI); Sub-part 15: Transport layer independent Additional Network Feature, Mobility Management (ANF-ISIMM)".
- [5] ETSI EN 300 392-7: "Terrestrial Trunked Radio (TETRA); Voice plus Data (V+D); Part 7: Security".
- [6] ETSI EN 300 392-11-6: "Terrestrial Trunked Radio (TETRA); Voice plus Data (V+D); Part 11: Supplementary services stage 2; Sub-part 6: Call Authorized by Dispatcher (CAD)".
- [7] ETSI EN/ETS 300 392-12 (all parts): "Terrestrial Trunked Radio (TETRA); Voice plus Data (V+D); Part 12: Supplementary services stage 3".
- [8] ETSI EN 300 395-2: "Terrestrial Trunked Radio (TETRA); Speech codec for full-rate traffic channel; Part 2: TETRA codec".
- [9] ISO/IEC 11571: "Information technology - Telecommunications and information exchange between systems - Private Integrated Services Networks - Addressing".
- [10] ETSI EN 300 392-1: "Terrestrial Trunked Radio (TETRA); Voice plus Data (V+D); Part 1: General network design".

2.2 Informative references

References are either specific (identified by date of publication and/or edition number or version number) or non-specific. For specific references, only the cited version applies. For non-specific references, the latest version of the referenced document (including any amendments) applies.

NOTE: While any hyperlinks included in this clause were valid at the time of publication, ETSI cannot guarantee their long term validity.

The following referenced documents are not necessary for the application of the present document but they assist the user with regard to a particular subject area.

- [i.1] ETSI EN 300 392-9: "Terrestrial Trunked Radio (TETRA); Voice plus Data (V+D); Part 9: General requirements for supplementary services".
- [i.2] Recommendation ITU-T Z.100: "Specification and Description Language (SDL)".
- [i.3] Recommendation ITU-T I.130: "Method for the characterization of telecommunication services supported by an ISDN and network capabilities of an ISDN".
- [i.4] Recommendation ITU-T E.164: "The international public telecommunication numbering plan".
- [i.5] Recommendation ITU-T X.121: "International numbering plan for public data networks".
- [i.6] ETSI EN 300 392-3-3: "Terrestrial Trunked Radio (TETRA); Voice plus Data (V+D); Part 3: Interworking at the Inter-System Interface (ISI); Sub-part 3: Additional Network Feature Group Call (ANF-ISIGC)".
- [i.7] ETSI TS 100 392-3-10: "Terrestrial Trunked Radio (TETRA); Voice plus Data (V+D); Part 3: Interworking at the Inter-System Interface (ISI); Sub-part 10: General design, PSS1 over E.1".
- [i.8] ETSI TS 100 392-3-11: "Terrestrial Trunked Radio (TETRA); Voice plus Data (V+D); Part 3: Interworking at the Inter-System Interface (ISI); Sub-part 11: General design, SIP/IP".
- [i.9] ETSI TS 100 392-3-14: "Terrestrial Trunked Radio (TETRA); Voice plus Data (V+D); Part 3: Interworking at the Inter-System Interface (ISI); Sub-part 14: Transport Layer Independent Additional Network Feature Short Data Service (ANF-ISISDS)".
- [i.10] ETSI TS 100 392-3-8: "Terrestrial Trunked Radio (TETRA); Voice plus Data (V+D); Part 3: Interworking at the Inter-System Interface (ISI); Sub-part 8: Generic Speech Format Implementation".

3 Definitions and abbreviations

3.1 Definitions

For the purposes of the present document, the following terms and definitions apply:

controlling linked group: group in a set of linked groups which is homed in the group linking controlling SwMI

controlling SwMI: functional entity which sets up and maintains a call between two or more SwMIs

group home SwMI: SwMI where the Group Home DataBase (G-HDB) resides

NOTE: The MNI of the group home SwMI is equal to that of that group.

group linking controlling SwMI: SwMI which controls the group linking of one of its own groups to one or more and which controls a group call on a linked group

NOTE: The group linking controlling SwMI is the home SwMI of the linked groups.

group linking home SwMI: See group linking controlling SwMI.

group linking participating SwMI: SwMI that participates in the group linking by linking (joining) one group to the group linking

group visited SwMI: SwMI not equal to group home SwMI

individual subscriber home SwMI: home of the MS's ITSI, i.e. the SwMI where the network code (MNC) is equal to that of the individual subscriber (ITSI)

ISI session: relation between two ANF-ISI entities in different SwMIs conveying ISI PDUs

linked group: group linked to one or more group identities from different TETRA

originating SwMI: entity from where the call originates, i.e. where the initial call set-up is detected

NOTE: Once the call has been connected, the originating SwMI becomes a participating SwMI.

participating linked group: group in a set of linked groups which is homed in the group linking participating SwMI

participating SwMI: functional entity which only participates in the call without controlling it and will always be the end point of the call

served SwMI: functional entity that is involved in a group call either as the originating SwMI, the controlling SwMI or as the participating SwMI, hence utilizing the ANF-ISIGC service

3.2 Abbreviations

For the purposes of the present document, the following abbreviations apply:

AL	Ambience Listening
ANF	Additional Network Features
AP	Access Priority
APDU	Application Protocol Data Unit
AS	Area Selection
BIC	Barring of Incoming Calls
BOC	Barring of Outgoing Calls
CAD	Call Authorized by Dispatcher
CC	Call Control
CCBS	Call Completion to Busy Subscriber
CCNR	Call Completion on No Reply
CFB	Call Forwarding on Busy
CFNRc	Call Forwarding on Not Reachable
CFNRy	Call Forwarding on No Reply
CFU	Call Forwarding Unconditional
CLIP	Calling Line Identification Presentation
CLIR	Calling/connected Line Identification Presentation
COLP	Connected Line Identification Presentation
CR	Call Report
CRT	Call ReTention
CRV	Call Retention Value
CSwMI	Controlling Switching and Management Infrastructure
CW	Call Waiting
DCK	Derived Cipher Key
DGNA	Dynamic Group Number Assignment
DL	Discreet Listening
DTMF	Dual Tone Multi Frequency
FE	Functional Entity
GC	Group Call
G-HDB	Group Home Data Base
GSSI	Group Short Subscriber identity
GTSI	Group TETRA Subscriber Identity
HOLD	call Hold
IC	Include Call
I-HDB	Individual Home Data Base

ISDN	Integrated Services Digital Network
ISI	Inter-System Interface
ISIGC	Inter-System Interface Group Call
ISIIC	Inter-System Interface Individual Call
ISIMM	ISI Mobility Management
ISISD	ISI Short Data
ISISS	Inter-System Interface Supplementary Service
ITSI	Individual TETRA Subscriber Identity
LCSwMI	Linking Controlling SwMI
LE	Late Entry
LSC	List Search Call
MM	Mobility Management
MNC	Mobile Network Code
MNI	Mobile Network Identity
MS	Mobile Station
MSC	Message Sequence Charts
OSwMI	Originating SwMI
PC	Priority Call
PDU	Protocol Data Unit
PISN	Private Integrated Services Network
P-LDB	Participating Linking Data Base
PPC	Pre-emptive Priority Call
PSS1	Private Integrated Signalling System Number 1
PSTN	Public Switched Telephone Network
PSwMI	Participating SwMI
PTT	Push To Talk
SAP	Service Access Points
SCK	Static Cipher Key
SDL	Specification and Description Language
SNA	Short Number Addressing
SS	Supplementary Service
SSI	Short Subscriber Identity
SwMI	Switching and Management Infrastructure
TPI	Talking Party Identification
TX	Transmitting

4 ANF-ISIGC stage 1 specification

4.1 Description

4.1.1 General description

ANF-ISIGC enables point to multipoint calls to be set-up between TETRA users located in more than one TETRA Switching and Management Infrastructure (SwMI), over the Inter-System Interface (ISI). In support of this, the ANF-ISIGC which operates at the ISI, shall detect a request from the originating SwMI for establishing one point to multipoint TETRA group call service between two or more TETRA SwMIs.

For originating requests the ANF-ISIGC provides access to the user profiles for both the calling individual TETRA user as well as it provides access to the user profile of the called TETRA group. The information is used for routing purposes and call contention checking. ANF-ISIGC also forwards the group call indication to the participating TETRA SwMIs.

For the duration of the call, the ANF-ISIGC shall handle transmission control signalling from all participating TETRA SwMIs. This is to ensure that transmission granting is only given to one of the individual TETRA users participating in the group call according to the point to multipoint TETRA call procedures defined in ETSI EN 300 392-2 [1].

ANF-ISIGC may also be used to transport group related supplementary services between TETRA SwMIs.

For the inter system group call service it is expected that there is fully meshed connectivity between all involved SwMIs in a call. A not existing ISI connection or a failed ISI connection is seen as an exceptional situation.

4.1.2 Qualifications on applicability to TETRA basic services

ANF-ISIGC is applicable to the following point to multipoint basic services as defined in ETSI EN 300 392-2 [1]:

- point to multipoint one slot TETRA clear mode speech;
- point to multipoint one slot TETRA end-to-end encrypted speech;
- point to multipoint one slot 2,4 kbit/s, 4,8 kbit/s or 7,2 kbit/s TETRA circuit mode data;
- point to multipoint end-to-end encrypted one slot 2,4 kbit/s, 4,8 kbit/s or 7,2 kbit/s TETRA circuit mode data;
- point to multipoint $N \times 2,4$ kbit/s, $N \times 4,8$ kbit/s or $N \times 7,2$ kbit/s TETRA circuit mode data, with $N = 2, 3$ or 4;
- point to multipoint end-to-end encrypted $N \times 2,4$ kbit/s, $N \times 4,8$ kbit/s or $N \times 7,2$ kbit/s TETRA circuit mode data, with $N = 2, 3$ or 4.

4.2 Procedures

4.2.1 Provision/withdrawal

ANF-ISIGC shall be permanently available or controlled by provision/withdrawal.

4.2.2 Normal procedures

4.2.2.1 Activation/deactivation/registration/interrogation

ANF-ISIGC shall be permanently activated on provision and permanently deactivated on withdrawal.

Registration and interrogation are not applicable to this ANF.

4.2.2.2 Invocation and operation

ANF-ISIGC is an extension of TETRA SwMI call control over an Inter-System Interface, as documented by ETSI EN 300 392-2 [1]. The relation between the ANF-ISIGC and the transport layer protocol is described in the transport dependent General Design documents.

4.2.2.3 ANF-ISIGC - the service provider

4.2.2.3.1 General

ANF-ISIGC shall be a SwMI V+D layer 3 (network layer) service provider. ANF-ISIGC shall offer services to SwMI CC applications.

The generic stage 1 service model is illustrated in figure 4.1. The control aspects of the services are defined in terms of primitives. The primitives are sent across the ISIGC Service Access Points (SAP) (ISIGC-SAPs) between the service provider and the service users. The ANF-ISIGC services use the following four generic service primitives:

- request (req);
- indication (ind);
- response (resp); and
- confirm (conf).

The service-specific primitives are defined for each service as part of the stage 1 service description in the following clauses. In the stage 1 descriptions, the ANF-ISIGC shall be seen as one entity.

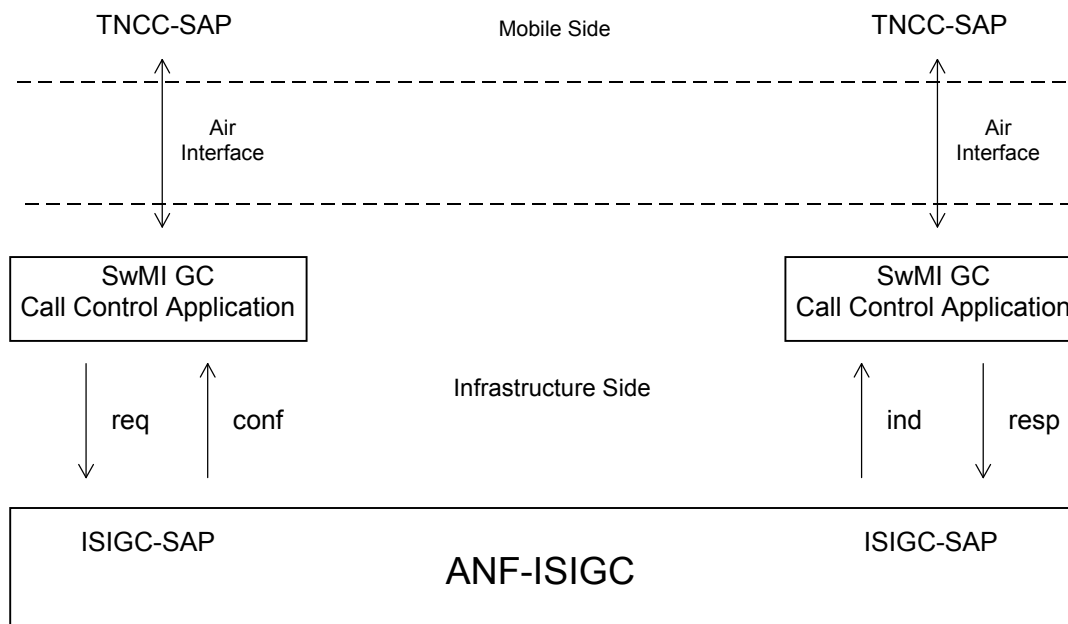

Figure 4.1: ANF-ISIGC stage 1 service model

4.2.2.3.2 Establishing the group call at the originating and controlling TETRA SwMI

ANF-ISIGC shall be invoked when a group call request has been received by the OSwMI and analysis of the originating MS's profile and destination group identity has shown that the invocation is necessary and allowed and a routing path to the involved SwMI exist.

The request for group call establishment from the OSwMI CC application to the ANF-ISIGC entity shall include the following information used in the analysis for routing and call set-up purposes in the CSwMI:

- basic service information;
- called party identity specified by the GTSI;
- priority of the call, e.g. emergency call priority.

The following cases are identified:

- 1) the call is initiated from the home SwMI of the called group and at least one of the members of the called group has attached to the group from another TETRA SwMI based on G-HLR information;
- 2) the call is initiated from another SwMI than home SwMI of the called group;
- 3) the call is initiated from the home SwMI of the called group and the called group is (based on the available information in the originating SwMI P-LDB database) statically or dynamically linked to a group in another TETRA SwMI and the other SwMI is designated as the controlling SwMI for the pair of groups;
- 4) the call is initiated from the home SwMI of the called group and the called group is (based on the available information in the originating SwMI C-LDB database) statically or dynamically linked to group(s) in other TETRA SwMI(s) and the group home SwMI is designated as the controlling SwMI for the set of groups, and there may be members of the linked groups in the participating TETRA SwMIs;
- 5) the call is initiated from another SwMI than the home SwMI of the called group and the group home SwMI has instructed the originating SwMI about the identity of the controlling SwMI.

In cases (2), (3) and (5) the ANF-ISIGC shall forward the call request over the ISI to the destination (controlling) SwMI CC application using the result of the analysis found in the originating SwMI.

In case (2) the destination SwMI is the group home SwMI determined by the called GTSI. If the destination SwMI is not the controlling SwMI for a set of linked groups, the group home SwMI shall inform the originating SwMI to re-route the call request to the linking controlling SwMI. The procedure shall continue as in case (5).

In case (3) the destination SwMI, the linking controlling SwMI, is determined by the statically or dynamically group linking information available in the P-LDB of the originating SwMI.

In case (5) the destination SwMI, the linking controlling SwMI, is determined by the group linking information received from the group home SwMI.

In cases (1) and (4) the OSwMI is also the CSwMI and the local call control has already accepted the call if ANF-ISIGC is invoked. In other cases ANF-ISIGC entity shall pass the call request received from an OSwMI CC to the CSwMI CC application for evaluation. After analysis of the called group profiles, the SwMI CC application shall inform the ANF-ISIGC entity of the analysis result. If the group call is accepted, the ANF-ISIGC entity shall analyse the called group identity and establish calls towards all relevant SwMIs. If the group call is not accepted, the ANF-ISIGC entity shall inform the rejection to the OSwMI.

NOTE 1: The CSwMI may change the priority and basic service information of the group call, e.g. if the CSwMI cannot support the call priority received from the OSwMI.

The ANF-ISIGC shall establish a call over ISI to the (linking) PSwMI(s) in which call participants may be located. The destinations SwMIs are determined by the statically and/or dynamically group linking information stored to C-LDB and/or (linked) group attachment information received from another TETRA SwMI(s) and stored to G-HDB.

NOTE 2: The CSwMI for the linked group is determined by the time of linkage.

An OSwMI may contain multiple parties who are trying to set-up a compatible group call at the same time.

The set-up of a group call may involve more than one OSwMI but only a single CSwMI.

Once the CSwMI CC has given the OSwMI CC permission to continue with the call the ANF-ISIGC entity passes the information to the OSwMI CC application. If the call parameters were not changed by CSwMI or the changes are accepted by the OSwMI then the OSwMI may indicate that it is ready for the call to be connected. It is an implementation specific decision as to when the OSwMI decides to indicate this. Possible modes of acceptance are:

- 1) The OSwMI indicates acceptance if it has resources available to connect a calling party.
- 2) The OSwMI indicates acceptance if it has resources available to connect any party at the SwMI.
- 3) The OSwMI indicates acceptance if it has resources available to connect a calling party and a called group member at the SwMI.
- 4) The OSwMI indicates acceptance only when it has resources available to connect all group member parties at the SwMI.
- 5) The OSwMI indicates acceptance when it has resources available to connect a calling party and all group members at the SwMI.
- 6) If it has not already done so, the OSwMI indicates acceptance after a defined period.

For the most predictable call set-up mechanism mode 1 is recommended.

If the OSwMI CC is not able to indicate, within the time indicated by the Setup response time out information element, that it is ready to be connected it may indicate the delay to the CSwMI.

The OSwMI(s) shall also indicate in a set-up response back to the CSwMI the mode of operation used to allocate resources, used for transmission over the ISI, during the group call. There are two modes of operation for a SwMI to allocating resources during the call maintenance phase:

- permanently allocated resources;
- temporary allocated resources.

For permanently allocated resources, all resources (air interface and infrastructure resources) reserved during call set-up shall be available for the duration of the active group call. For temporary allocation resources, the CSwMI shall for each new transmission request ask each SwMI with temporary resources if they have resources available.

NOTE 3: The two modes of operation (permanently allocated resources/temporary allocated resources) when transmitting over ISI is not directly related to the air-interface trunking method. However, message trunking is needed in order to ensure "permanently allocated resource" mode.

The CSwMI may invoke other SwMIs than the OSwMI(s) in the call dependent of the information available in the G-HLR data base and or the C-LDB database. The CSwMI shall collect all set-up responses, both acceptances and rejects, from the invoked SwMI(s). The controlling SwMI CC application shall then determine whether the call can be set-up as either a complete or partial group call, if the group call shall be delayed or if the group call shall be released. When it is determined to progress the group call, the originating SwMI and participating SwMI(s), shall be informed to connect the members of the group call. At this point in the call, the originating SwMI shall connect the calling user. The originating SwMI shall then change status to a participating SwMI. The originating SwMI shall cease to exist.

4.2.2.3.3 Establishing the group call at a participating TETRA SwMI

When receiving a call setup from the CSwMI CC the ANF-ISIGC entity shall pass the call request received to the CC application in the PSwMI(s). The PSwMI(s) CC shall evaluate if resources necessary (air interface and infrastructure resources) for the group call are available and that group members exist in the SwMI. If a group call is accepted in the invoked SwMI(s), the necessary resources shall be reserved.

In case the members of the participating linked group are located in other SwMIs than the group home SwMI, the group linking participating SwMI may expand the call to these involved SwMI(s) and act as transit SwMI for the group call by delivering the call maintenance signalling and voice between the group controlling SwMI and the SwMI(s) where the members of the participating linked group are located.

NOTE 1: This possibility should only be used if the optional feature Linked Group Attachment as described in ANF-ISIMM [4], clause 19 is not supported.

It is an implementation specific matter to decide when the PSwMI is ready to accept the participation in the call. Possible modes of acceptance include:

- 1) The PSwMI indicates acceptance if it has resources available to connect at least one group member party at the SwMI.
- 2) The PSwMI indicates acceptance if it has resources available to connect all critical users at the SwMI.
- 3) The PSwMI indicates acceptance only when it has resources available to connect all group member parties at the SwMI.
- 4) If it has not already done so, the PSwMI indicates acceptance after a defined period.
- 5) The PSwMI indicates acceptance once it has determined that it has called group members present.

The recommended method is mode 5. This gives the most predictable call set-up mechanism.

If the PSwMI is not able to indicate, within the time indicated by the Setup response time-out information element, that it is ready to be connected it may indicate the delay to the CSwMI.

The CC in the invoked SwMI(s) shall then indicate in a set-up response back to the controlling SwMI the mode of operation used to allocate resources, used for transmission over the ISI, during the group call. There are two modes of operation for a participating SwMI to allocating resources during the call maintenance phase:

- permanently allocated resources;
- temporary allocated resources.

The set-up response shall also indicate the security level in air interface and whether the SwMI can support the communication type (normal, acknowledge or broadcast calls) indicated in the set-up indication.

NOTE 2: Negotiation of the service at set-up cannot be done for a group call (refer to ETSI EN 300 392-2 [1]). However, in case of non-acceptance of the communication type, the invoked SwMI may indicate which type of group call it can support (normal, acknowledge or broadcast). It is then up to the controlling SwMI to decide if the call is to be set-up to the specific SwMI. Otherwise, the invoked SwMI has no other alternative than to reject the call request if it cannot accept the indicated service at set-up.

A PSwMI may become an OSwMI during call setup if a new calling party appears at the PSwMI.

4.2.2.3.4 Delaying the group call

The controlling SwMI CC application can determine to delay set-up of the group call if an invoked SwMI (the originating SwMI or a participating SwMI) has responded to the group call set-up request with an indication that the call set-up should be delayed. The group call shall only be delayed if no reject cause has been received from another SwMI participating in the call that can result in group call release.

NOTE 1: A partial group call may be set-up even though an invoked SwMI wishes to delay the group call set-up.

When the controlling SwMI CC application determines to delay the group call, the ANF-ISIGC entity shall be informed. The ANF-ISIGC entity shall then inform all involved SwMI(s) of the delay. Resources reserved by the originating SwMI and participating SwMI(s) during call set-up may be released. Only ISI channel resources shall be preserved. An ISI delay timer shall be initiated in the controlling SwMI when a group call is delayed. This timer is used to release ISI channel resources and delaying SwMI(s), if no response is received from the delaying SwMI(s) within a certain period of time.

A response that the call is allowed to proceed in the delaying TETRA SwMI shall be provided to the ANF-ISIGC entity when this SwMI becomes available. The ANF-ISIGC entity shall convey the response to the controlling SwMI. The controlling SwMI CC application shall then again determine whether the call can be set-up as either a complete or partial group call, if the group call shall continue to be delayed or if the group call shall be released. If the group call is accepted, the originating SwMI and participating SwMI(s), shall be informed to connect the members of the group call.

NOTE 2: The controlling SwMI may at any time decide to continue a delayed call set-up. When a delaying PSwMI informs the CSwMI that it is ready to proceed with call set-up, it should be included in the call.

It is an implementation decision as to when the CSwMI decides that it can connect the call. Possible modes of call connection are:

- 1) The CSwMI connects the call as soon as any SwMI is "ready".
- 2) The CSwMI connects the call as soon as any OSwMI is "ready".
- 3) The CSwMI connects the call as soon as both an OSwMI and a PSwMI are "ready".
- 4) The CSwMI connects the call as soon as both a calling OSwMI and all PSwMIs are "ready".

For the most predictable operation mode 2 is recommended.

When the CSwMI connects the call it indicates to all OSwMIs which of those calling parties that are available and "ready" is to be the calling party of the call.

When a call is connected the CSwMI may send to any delaying SwMIs an indication that the call has been connected. This allows those SwMIs to connect their parties, that are already "ready", in a timely manner.

4.2.2.3.5 Control of call time-out timers

The controlling SwMI shall indicate the time allowed to the originating and participating SwMIs to make the needed preparation like channel reservations for the call. If the receiving SwMI is not able to respond to the call setup request within the time defined in the call setup request it shall either a request for a delay or a rejection to the call request to the CSwMI.

Call time-out for the call set-up phase may be defined by the controlling SwMI. The controlling SwMI CC application may indicate its time-out value to the originating SwMI. The originating SwMI CC application should then either use the indicated time-out value or define a larger value for its corresponding timer. The call time-out value for the call set-up phase shall be conveyed to the originating SwMI(s) following a forward set-up request.

The call time-out timer used during the maintenance phase of the call shall also be defined by the controlling SwMI CC application. The controlling SwMI CC application shall indicate this time-out value to the involved SwMI(s). The SwMI(s) CC application should then either use the indicated time-out value or define a larger value for its corresponding timer. The call time out value shall be conveyed to the invoked SwMI(s) during call set-up.

NOTE: While the exchange of time-out values has been specified in the protocol, the use of the time-out values is optional. However, if the originating/participating SwMI(s) do not use the given timer values, the risk of call attempt failure (due to premature call establishment time-out) or call disconnection (due to premature call duration time-out) can be increased.

4.2.2.3.6 Acknowledged group call procedures

For acknowledged group calls, the controlling SwMI shall request participating SwMI(s) to poll group members within a called group. The controlling SwMI CC application shall send a poll request to the ANF-ISIGC entity indicating whether the number or percentage of poll responses is wanted from each participating SwMI. The poll request shall be forwarded to all participating SwMI(s) supporting acknowledge group call.

NOTE: Polling of group members can only occur after the call has been established. However, it is implementation independent how many times a group may be polled during the call maintenance phase.

When polling group members, the controlling SwMI can decide either to let the call proceed immediately by giving the calling user permission to transmit before, during or after the participating SwMI(s) have responded to the polling request.

The ANF-ISIGC entity shall convey all received polling responses from the participating SwMI(s) back to the controlling SwMI CC application. After a certain period of time, all received responses shall be evaluated. The controlling SwMI may disconnect the call if an insufficient number of responses have been received.

It is an option of the controlling SwMI as how and when to inform the calling user or any other user of the polling result.

4.2.2.3.7 Colliding call setup signalling

Call collisions can occur when two SwMIs simultaneously send a call set-up request to each other regarding the same group. The two calls are then colliding:

- within the controlling SwMI when a forward group call set-up request is received within the window where the controlling SwMI is waiting for a call set-up responses to the same group from SwMIs that are to participate in the group call;
- within the originating SwMI when a group call set-up request is received within the window where the originating SwMI is waiting for a group call set-up request (as a response to forward group call request) to the same group however with a different originating SwMI identity than the one received.

If the requested basic services are compatible for the colliding calls, then the CSwMI should amalgamate the calls and if the amalgamation is performed it shall inform OSwMI(s) about the call amalgamation in the group call set-up request. Upon reception of information about call amalgamation in the group call set-up request, the originating SwMI shall accept the incoming call set-up request and discard its own outgoing call set-up request.

Otherwise, the CSwMI call control application shall reject the call set-up request - unless it is an emergency call request.

If a controlling SwMI receives call setup request with emergency priority to the same group to which it is already establishing a group call with a non-emergency priority, the CSwMI shall release the original initiated call and establish the emergency call towards all SwMIs.

4.2.2.3.8 Joining of calls

This clause defines the scenarios when call setup signalling does not collide, that is, call setup request is only sent from OSwMI towards the CSwMI when CSwMI has either an ongoing call on the same group or the call establishment is in progress.

When the controlling SwMI receives more than one call set-up request to the same group the CSwMI shall either join the calls into one call or reject the new call setup request. Joining of calls shall happen when:

- the CSwMI receives forward call setup request from an OSwMI within the window of processing the first received call set-up request (originated from CSwMI or another SwMI);
- when the CSwMI during the call set-up phase receives a call set-up request from a SwMI not included in a call set-up;
- when the CSwMI during an active call receives a call set-up request from a SwMI not included in the call.

If the requested basic services are compatible for the joining call requests, then the controlling SwMI should amalgamate the calls and may inform the new participating SwMI about call amalgamation in the group call set-up request. Otherwise the CSwMI may reject the call request.

If the CSwMI simultaneously receives multiple call setup requests with incompatible basic services the CSwMI shall evaluate which call shall continue and which shall be rejected.

If the CSwMI receives a call setup request with emergency priority towards an existing call with normal priority, the CSwMI shall release the original call and establish a new call with emergency priority.

If the CSwMI receives a call setup request with non-emergency priority towards an existing call with emergency priority, the CSwMI shall include the new SwMI in the existing call.

If the CSwMI receives several simultaneous call setup requests and one call request has emergency priority the CSwMI shall continue the call with the emergency priority and reject all other call requests.

4.2.2.3.9 Maintenance of the group call

Transmission control:

The ANF-ISIGC entity shall remain operational for the duration of the call, controlling the TETRA group call across the ISI using TETRA signalling messages defined as:

- transmission cease information, which informs that the transmission from a user is ceased or a queued transmission request is cancelled. In the first case the CSwMI informs all participating SwMIs about the transmission cease;

NOTE 1: All participating SwMIs operating in "temporary allocated resource" mode are permitted to release the relevant resources for the transmission.

- transmission request information, where a participating SwMI requests the right to transmit;
- transmission not granted information which informs a participating SwMI that the transmission request is rejected;
- transmission queued information which informs a participating SwMI that the transmission request is queued (not immediately granted);
- resource reservation request where all participating SwMIs operating in "temporary allocated resource" mode are inquired to reserve the relevant resources for the transmission;
- transmission delay information, when:
 - a participating SwMI with "temporary resources allocation" does not have any resources available, upon a resource reservation request; or when
 - the controlling SwMI is setting up the call to a new participating SwMI during transmission handling and the new participating SwMI request for a call set-up delay;

- transmission grant information which informs the participating SwMIs who has been granted;
- transmission withdraw information, where a participating SwMI requests to withdraw from the call when resources are required to another call or a temporary pause is needed. The controlling SwMI shall determine whether the call can continue as a partial group call or if the complete group call shall be present to continue;
- transmission continue information, where a participating SwMI requests to continue with the withdrawn call;
- transmission interrupt information, where a user requests current transmission to be interrupted due to higher priority and where the participating SwMIs are informed about an interruption of the transmission in progress and who is now granted the right to transmit.

The ANF-ISIGC entity may contain a queuing mechanism for transmission request. When a TETRA user wishes to transmit, a transmission request shall be sent to the participating SwMI. The participating SwMI CC application shall then convey the transmission request to the ANF-ISIGC entity.

Upon reception of a request to transmit, the ANF-ISIGC entity shall evaluate if any conflicting transmission requests are received, e.g. only one participating SwMI shall be awarded the right to transmit while other transmission requests may be queued or rejected. If the transmission request is not queued or rejected, then all participating SwMI(s) without permanent allocated resources shall be requested by the ANF-ISIGC entity, to evaluate if necessary air interface and infrastructure resources are available for transmission.

If resources are available for transmission at the inquired participating SwMI(s), the necessary resources shall be reserved. The inquired SwMI(s) shall respond back to the ANF-ISIGC entity whether resources are available or not.

The ANF-ISIGC entity shall collect all responses, both acceptances, delay and rejects request, from the inquired SwMI(s) and evaluate if transmission can be performed as either a complete grant of transmission, partial grant of transmission or if the transmission request shall be rejected. The transmission request shall be rejected by ANF-ISIGC if important or critical SwMI(s) cannot participate in the transmission grant.

Each time a request to transmit is received in the controlling SwMI, the ANF-ISIGC entity should fetch group location information, to evaluate if new group members have registered to a SwMI not already participating in the group call. If new SwMI(s) are to be joined to the active call, a set-up request shall be sent to the new participating SwMI. The new participating SwMI will join the call according to normal call set-up procedures. However, the connect or release response sent from the controlling SwMI during call set-up shall be used together with the collected resource responses to evaluate if transmission can be granted to the requesting user.

Transmission delay:

Transmission delay request are made by participating SwMIs either due to a participating SwMI with "temporary resources allocation" not having enough resources available, upon a resource reservation request or due to a new participating SwMI requesting call set-up delay. The actual decision to delay transmission granting shall be determined by the controlling SwMI.

NOTE 2: A partial grant of transmission may be performed even though one or more participating SwMIs do not have resources available.

When the controlling SwMI CC application determines that grant of transmission shall be delayed, the ANF-ISIGC entity shall be informed. The ANF-ISIGC entity shall release all new participating SwMIs, i.e. this is the same procedure as delay during call set-up, and inform each participating SwMI with temporary resources that transmission handling has ceased. Resources reserved by new participating SwMIs and participating SwMIs with temporary resources should be released. Only ISI channel resources shall be preserved. An ISI delay timer shall be initiated in the controlling SwMI upon delay. This timer is used to:

- release ISI channel resources to new PSwMI(s) and initiation of call release to all active SwMIs, if no response is received from the delaying SwMI within a certain period of time;
- grant transmission to the requesting user after a new set of resource reservation sequences has been performed and new PSwMI(s) have been set-up in the call; or
- grant transmission permission to another user. In this case, call set-up to the new PSwMI(s) and resource reservation sequences will be performed again.

When the delaying SwMI has the necessary resources available to perform transmission, a resource reserved or call set-up continue response shall be provided back to the ANF-ISIGC entity. The ANF-ISIGC entity shall convey the response back to the controlling SwMI CC application. The controlling SwMI CC application shall again set-up the call to new participating SwMIs and request for resource reservation in participating SwMIs with temporary resources. Once this has been performed transmission granting may be performed.

The controlling SwMI may at any time decide to continue a delayed transmission granting. When a delaying SwMI receives a transmission grant indication with transmission granted to another user, the delayed SwMI shall follow the indicated transmission when resources become available without informing the controlling SwMI that resources are now available.

Service modification:

For the duration of a group call, modification to the services can be provided by the ANF-ISIGC entity. The service modification can only take place for services within the scope of this ANF. The service may be changed between any combination of one or more of the following:

- a point to multipoint one slot TETRA clear call (circuit mode data or speech) may be modified to a point to multipoint one slot TETRA end-to-end encrypted call;
- a point to multipoint one slot TETRA end-to-end encrypted call (circuit mode data or speech) may be modified to a point to multipoint one slot TETRA clear call;
- a 4-slots-per-frame circuit mode data call may be changed to a 1-slot, 2-slot or 3-slot call;
- a 3-slot circuit mode data call may be changed to a 1-slot or 2-slot;
- a 2-slot circuit mode data call may be changed to a 1-slot;
- a TETRA circuit mode data call (either clear or encrypted) with a data rate of 2,4 kbit/s, 4,8 kbit/s or 7,2 kbit/s may be changed to a different data rate, i.e.:
 - 2,4 kbit/s may be modified to 4,8 kbit/s or 7,2 kbit/s;
 - 4,8 kbit/s may be modified to 2,4 kbit/s or 7,2 kbit/s;
 - 7,2 kbit/s may be modified to 2,4 kbit/s or 4,8 kbit/s; or
 - to a circuit mode speech call;
- a TETRA circuit mode speech call (either clear or encrypted) may be changed to a circuit mode data call with a data rate of 2,4 kbit/s, 4,8 kbit/s or 7,2 kbit/s.

4.2.2.3.10 Termination of the group call

Only the controlling TETRA SwMI shall be in control of the termination of the call. When a participating SwMI requests for call disconnection, ANF-ISIGC shall route this request over the ISI to the controlling TETRA SwMI CC application. The controlling TETRA SwMI CC application shall validate the call disconnection request and if found valid the controlling TETRA SwMI CC application may choose to either disconnect the entire group call or disconnect the group call partially by only releasing the requesting TETRA SwMI. The reasons to disconnect the call may either be:

- if a participating TETRA SwMI cannot support the call anymore, e.g. because of pre-emption of the resources is necessary or the call length timer of this particular SwMI has expired. The call may then be released partially, i.e. the call continues without the requesting TETRA SwMI;
- if the controlling SwMI fails to support the call anymore. The entire group call across all SwMIs shall be terminated;
- if the controlling home SwMI detects that the last member of the group at a SwMI has detached the group, the TETRA SwMI CC shall request the ANF-ISIGC entity to clear the ISI group call path to the particular PSwMI.

When a request to release the group call is received by the controlling SwMI, sent from the call owning user, the controlling SwMI CC application shall always release the entire group call even though the call owning user is located in a participating SwMI. The controlling SwMI shall however still have the possibility of releasing the call even though the call ownership is transferred to a served user in another SwMI.

4.2.3 Exceptional procedures

4.2.3.1 Activation/deactivation/registration/interrogation

Not applicable.

4.2.3.2 Invocation and operation

The ANF-ISIGC entity may reject the group call service request from the originating TETRA SwMI with an appropriate failure indication for any of the following reasons:

- if ISI connections are permanently not available;
- if ISI connections are temporary not available;
- if the maximum number of available ISI links have exceeded.

The controlling SwMI CC may reject the group call service request from the originating TETRA SwMI with an appropriate failure indication.

During the maintenance phase of the call the ANF-ISIGC may reject any signalling request with an appropriate failure indication if critical ISI connections become either temporarily or permanently unavailable due to pre-emption of the resources.

During the maintenance phase of the call the controlling SwMI CC may reject any signalling request with an appropriate failure indication.

4.3 Interaction with TETRA supplementary services and other TETRA ANFs

4.3.1 General

Interactions with other TETRA supplementary services and ANFs for which TETRA Standards or TETRA draft standards were available at the time of publication of the present document are specified below.

4.3.2 Calling Line Identification Presentation (SS-CLIP)

No interaction.

4.3.3 Connected Line Identification Presentation (SS-COLP)

No interaction.

4.3.4 Calling/Connected Line Identification Restriction (SS-CLIR)

No interaction.

4.3.5 Call Report (SS-CR)

No interaction.

NOTE: The originating SwMI will use ANF-ISISS for this service.

4.3.6 Talking Party Identification (SS-TPI)

No interaction.

NOTE: When TPI is invoked for a call, i.e. for a group, the SS-TPI signalling is transported transparently between the controlling SwMI and the participating SwMI(s) and is not considered to be an interaction.

4.3.7 Call Forwarding Unconditional (SS-CFU)

SS-CFU is applicable for group calls if the call is forwarded unconditionally from one group call to another.

ANF-ISIGC shall interact with SS-CFU when a group call is forwarded to a group located in a SwMI other than the called group home SwMI. The call shall be re-routed to the new group home SwMI.

4.3.8 Call Forwarding on Busy (SS-CFB)

Not applicable.

4.3.9 Call Forwarding on No Reply (SS-CFNRY)

Not applicable.

4.3.10 Call Forwarding on Not Reachable (SS-CFNRC)

Not applicable.

4.3.11 List Search Call (SS-LSC)

No interaction.

4.3.12 Call Authorized by Dispatcher (SS-CAD)

SS-CAD shall interact with ANF-ISIGC when SS-CAD is invoked towards the called group number and the calling user is located in a SwMI other than the restricted groups home SwMI.

4.3.13 Short Number Addressing (SS-SNA)

No interaction.

4.3.14 Area Selection (SS-AS)

SS-AS information shall be forwarded to the group/linking home SwMI. The SwMI shall use this information to set-up the group call.

NOTE 1: When Area Selection is invoked for a call, i.e. for a group, the SS-AS signalling is transported transparently between the originating SwMI and the controlling SwMI and is not considered to be an interaction.

NOTE 2: The area selection is encoded differently in the ISI protocol than in the air interface and the corresponding information element is named as "selected area number".

4.3.15 Access Priority (SS-AP)

No interaction. SS-AP only applies locally at the radio access.

4.3.16 Priority Call (SS-PC)

If SS-PC has been activated and call set-up operates by queuing, then each call shall be established according to the queuing mechanism implemented in the SwMI(s) for priority calls.

4.3.17 Call Waiting (SS-CW)

No interaction.

4.3.18 Call Hold (SS-HOLD)

No interaction.

4.3.19 Call Completion to Busy Subscriber (SS-CCBS)

No interaction.

4.3.20 Late Entry (SS-LE)

No interaction.

NOTE: When Late Entry is invoked for a call, i.e. for a group, the SS-LE signalling is transported transparently between the controlling SwMI and the participating SwMI(s) and is not considered to be an interaction.

4.3.21 Pre-emptive Priority Call (SS-PPC)

SS-PPC shall interact with ANF-ISIGC to pre-empt an inter-TETRA connection with the lowest Call Retention Value (CRV) among those which may be used to route the priority call. SS-PPC shall invoke pre-emption by forcing the clearing of the chosen inter-TETRA connection and then invoking a new ANF-ISIGC at the corresponding ISI.

4.3.22 Include Call (SS-IC)

SS-IC and ANF-ISIGC shall interact whenever the SS-IC served user active in a group call wants to include a user or group of users who are not members of the active group call and who are registered in a SwMI other than the controlling SwMI. The SS-IC shall request the ANF-ISIGC to include the affected user or group of users (user to be included) into the group call.

NOTE: Only the group call owner is allowed to invoke SS-IC for an active group call.

The group call request to each affected user may or may not involve setting up a new inter-TETRA connection to a new participating SwMI previously not part of the group call. In cases where the participating SwMI already contains participating group call members, the relevant messages shall be sent using the existing inter-TETRA connection. In cases where the participating SwMI is not already part of the group call a set-up message shall be sent using a new inter-TETRA connection.

4.3.23 Barring of Outgoing Calls (SS-BOC)

No interaction. SS-BOC is operated before ANF-ISIGC invocation.

4.3.24 Barring of Incoming Calls (SS-BIC)

No interaction.

NOTE: SS-BIC is operated in the called group's home SwMI CC application and supplementary service control application.

4.3.25 Discreet Listening (SS-DL)

No interaction.

4.3.26 Ambience Listening (SS-AL)

No interaction.

NOTE: The invocation of the supplementary service SS-AL constitutes a call set-up similar to an individual call.

4.3.27 Dynamic Group Number Assignment (SS-DGNA)

No interaction.

NOTE: When Dynamic Group Number Assignment is invoked for an existing group call, the SS-DGNA signalling is transported transparently between the controlling SwMI and the participating SwMI(s) using the existing inter-TETRA connection and is not considered to be an interaction.

4.3.28 Call Completion on No Reply (SS-CCNR)

Not applicable.

4.3.29 Call Retention (SS-CRT)

SS-CRT shall interact with the ANF-ISIGC by having the Call Retention Value (CRV) for the group call assigned to the inter-TETRA connection(s) used to route the call.

4.3.30 Additional Network Features - Inter-System Interface Individual Call (ANF-ISIIC)

No interaction.

4.3.31 ISI Short Data (ANF-ISISD)

No interaction.

4.3.32 ISI Mobility Management (ANF-ISIMM)

No interaction.

NOTE: All updating of the SwMI databases used for the operation of ANF-ISIGC are not to be considered as interactions between ANF-ISIMM and ANF-ISIGC.

5 ANF-ISIGC stage 2 specification

5.1 Functional model

5.1.1 Functional model description

The functional model shall comprise the following functional entities:

FE1 ISI group call originating entity.

FE1' Originating SwMI call control application functional entity.

- FE2 ISI group home controlling entity/group call controlling entity.
 FE2' Group home SwMI/Controlling SwMI call control application functional entity.
 FE3 ISI group call participating entity.
 FE3' Participating SwMI call control application functional entity.

The following functional relationships shall exist between these FEs:

- ra between FE1' and FE1.
 rc between FE1 and FE2 and between FE2 and FE2 in case of group linking or call forwarding.
 rd between FE2 and FE2'.
 rf between FE2 and FE3.
 rg between FE3 and FE3'.

Figure 5.1 shows the FEs and their relationships.

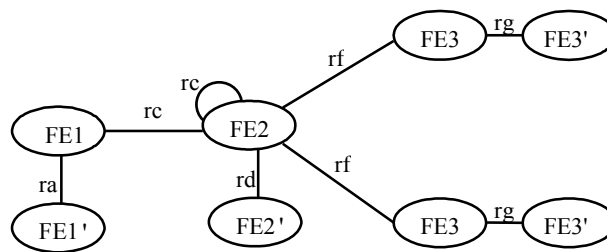

Figure 5.1: Functional model for the ANF-ISIGC

The relationship between the SwMI roles and the functional entities can be seen in figure 5.2.

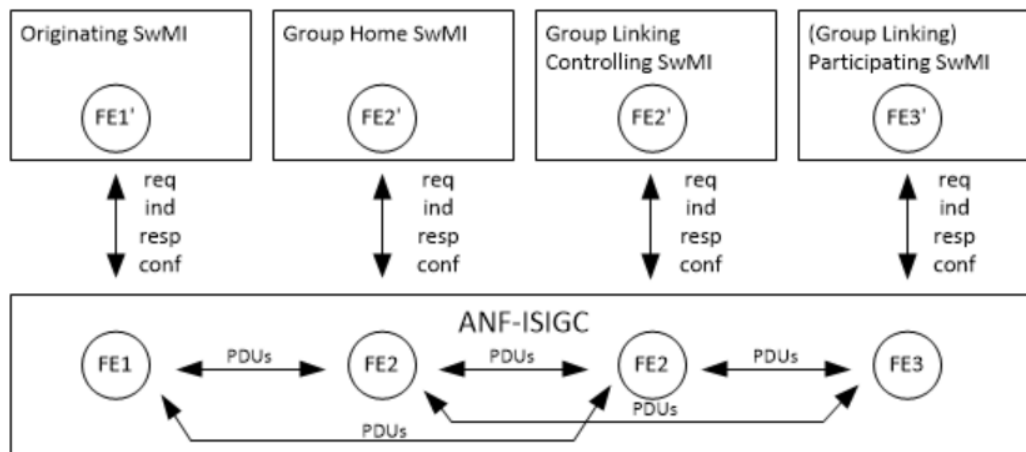

Figure 5.2: The relation between SwMI roles and functional entities

5.1.2 Description of functional entities

5.1.2.1 ISI group call originating entity, FE1

FE1 represents the ANF-ISIGC originating entity of the group call. The purpose of this FE shall be to receive an outgoing group call request from the originating SwMI CC and forward the call request to FE2.

This functional entity shall:

- detect an outgoing group call;
- determine routing to FE2;
- forward the call set-up request to FE2;
- re-route the call set-up request to a linking controlling SwMI or a new group home SwMI (when SS-CFU has been invoked);
- receive a set-up indication from FE2 for the initiated group call;
- receive the response on the delivered group call request from FE1' and forward the response to FE2;
- connect the calling user and invoke FE3 upon reception of a group call connect request;
- release the group call on request from FE2;
- receive request for group call release from FE1' and forward the request to FE2.

5.1.2.2 Originating SwMI CC application functional entity, FE1'

FE1' represents the CC application entity of the originating SwMI. This FE represents the existing call control functionality for a single SwMI. The purpose of this FE is to initiate the establishment of a group call when a set-up information flow is received from a calling user (at the air interface). FE1' should invoke FE1 when establishment of the call is to a group which, to FE1's knowledge, is controlled by in another TETRA network.

This functional entity may:

- detect an ISI outgoing group call;
- analyse the calling MS's profiles;
- analyse the called group number;
- invoke FE1 and forward the call set-up request;
- analyse set-up indication received from FE1 for the initiated group call;
- analyse resource availability and reserve resources;
- release the group call when requested by FE1;
- request to disconnect group call.

NOTE: FE1' is not part of the present document.

5.1.2.3 ISI group home entity/group call controlling entity, FE2

FE2 can represent either the ANF-ISIGC of the group home entity or the group linking controlling entity. After call set-up, FE2 shall always represent the controlling entity. The group home entity will only differ from the controlling entity when the called group is linked to a group located in another SwMI, and this other SwMI is the linking controlling SwMI.

FE2 shall be the central distribution and reception point for all group call signalling between FE3s, FE1 and FE2'. During the maintenance phase of the call, FE2 shall control all transmission granting.

This functional entity shall:

- receive forwarded group call request from FE1;
- determine routing over ISI to participating SwMIs;
- send call set-up to all FE3s and FE1 participating in the group call;
- perform transmission control during call maintenance phase;
- forward disconnect call request received from FE3 to FE2';
- clear the call to originating and participating SwMI (FE3) when requested by FE2'.

5.1.2.4 Group home SwMI/Controlling SwMI CC application functional entity, FE2'

FE2' represents the CC application entity of the group home SwMI or controlling SwMI. After call set-up, FE2' shall always represent the controlling SwMI CC application entity. The group home CC application entity will only differ from the controlling SwMI CC application entity when the called group is linked to a group located in another SwMI, and this other SwMI is the linking controlling SwMI.

FE2' represents the existing call control functionality for a single SwMI. This FE shall be the central point for all group call arbitration between FE3s, during call set-up, call maintenance and release.

This functional entity may:

- analyse incoming group call request from FE2;
- perform additional analysis of the called group number (determining the controlling SwMI);
- re-direction of the call when this SwMI is not the controlling SwMI or when the group call has been forwarded unconditionally;
- perform analysis of the called group profiles;
- analyse the call set-up response received via FE2 from all participating FE3s and FE1;
- initialize polling via FE2 of all participating FE3s in the case of acknowledged group call;
- analyse call set-up delays in the case of delay request;
- analyse withdraw and continue request received via FE2 from FE3;
- determine when the call is to be connected and when to be released;
- analyse call disconnection request received via FE2 from FE1 or FE3.

NOTE: FE2' is not part of the present document.

5.1.2.5 ISI group call participating entity, FE3

FE3 represents the ANF-ISIGC participating entity of the group call. This FE shall be an intermediary between FE2 and the participating SwMI CC application, FE3'. The participating SwMI may have one or more members of the group call registered either as resident or as visitor.

This functional entity shall:

- receive an incoming ISI group call setup request from FE2;
- receive the response on the group call request from the FE3' and forward the response to FE2;
- receive a polling request from FE2 and inform FE3' to poll group members;
- receive call information from FE2 and forward to FE3' or from FE3' and forward to FE2;

- receive continuation and withdrawal information from FE3' and pass it to FE2;
- receive transmission control information from FE2 and deliver it to FE3';
- receive transmission request and transmission cease from FE3' and forward the request to FE2;
- release the group call on request from FE2 and deliver it to FE3';
- receive request for group call release from FE3' and forward the request to FE2.

5.1.2.6 Participating SwMI CC application functional entity, FE3'

FE3' represents the CC application entity of the participating SwMI. This FE represents the existing call control functionality for a single SwMI. The purpose of this FE is to analyse group call set-up request from FE3 and forward this request to the called users (over the air interface).

This functional entity may:

- analyse group call set-up request received via FE3 from FE2;
- perform analysis on the called group number;
- analyse resource availability and reserve resources;
- poll group members over the air interface;
- request to withdraw from group call;
- request to continue with group call;
- forward transmission request and ceases from users to FE3 and responses to group participants;
- release the group call when requested by FE3;
- request to disconnect group call.

NOTE: FE3' is not part of the present document.

5.2 Information flow

5.2.1 Information flow diagrams

5.2.1.1 General Information about Information Flow Diagrams

This clause specifies the information flow scenarios for the ANF-ISIGC basic operation services and sequences arising from error situations.

NOTE: The information flow scenarios in stage 2 do not cover all possible signalling scenarios.

The MSCs will show the information flow of the primitives used between the SwMI internal elements and the PDUs used in ANF-ISIGC. The stage 3 description of ANF-ISIGC shall provide signalling procedures in support of the information flow sequences specified below.

In the information flow scenarios, ANF-ISIGC information flows are represented by solid arrows where the flow is given by the name above the flow. Within a column representing an ANF-ISIGC functional entity, the numbers refer to functional entity actions listed in clause 5.3.

The information flows do not take into account the physical location of the different functional entities. That means that the originating and the controlling SwMI functional entities might be collocated within the same physical SwMI and the information flow therefore becomes SwMI internal. In the same way the controlling SwMI entity and the participating SwMI entity are collocated within the same physical SwMI.

The following abbreviations are used:

req	request.
ind	indication.
resp	response.
conf	confirmation.

5.2.1.2 Successful group call set-up over ISI using ANF-ISIGC

Figures 5.3 through 5.9 show the information flow sequence for a successful group call set-up using ANF-ISIGC. The figures cover all five cases described in clause 4.2.2.3.2.

Scenario 1 (figures 5.3 to 5.5) shows the information flow for a successful group call establishment between the originating SwMI, the controlling SwMI and the participating SwMI. The scenario covers the following cases:

- The called group is not part of a set of linked groups; the group home SwMI is the controlling SwMI.
- The called group is included in a set of linked groups; the group home SwMI is also the linking controlling SwMI for the set of linked groups.

The MS is requesting a group call, the originating SwMI routes the request to the controlling SwMI which will setup the call between the originating SwMI, the controlling SwMI for the group and a participating SwMI.

Scenario 2 (figures 5.6 to 5.9) shows the information flow for a success full group call establishment where the called group is included in a set of linked groups and the group home SwMI is a linking participating SwMI in the set of linked groups.

The MS is requesting a group call, the originating SwMI routes the request to the group home SwMI, the group home SwMI detects that the group is linked to another group in the linking controlling SwMI and requests the originating SwMI to reroute the call request to the linking controlling SwMI. Afterwards the call setup information flow is equal to the information flow in scenario 1.

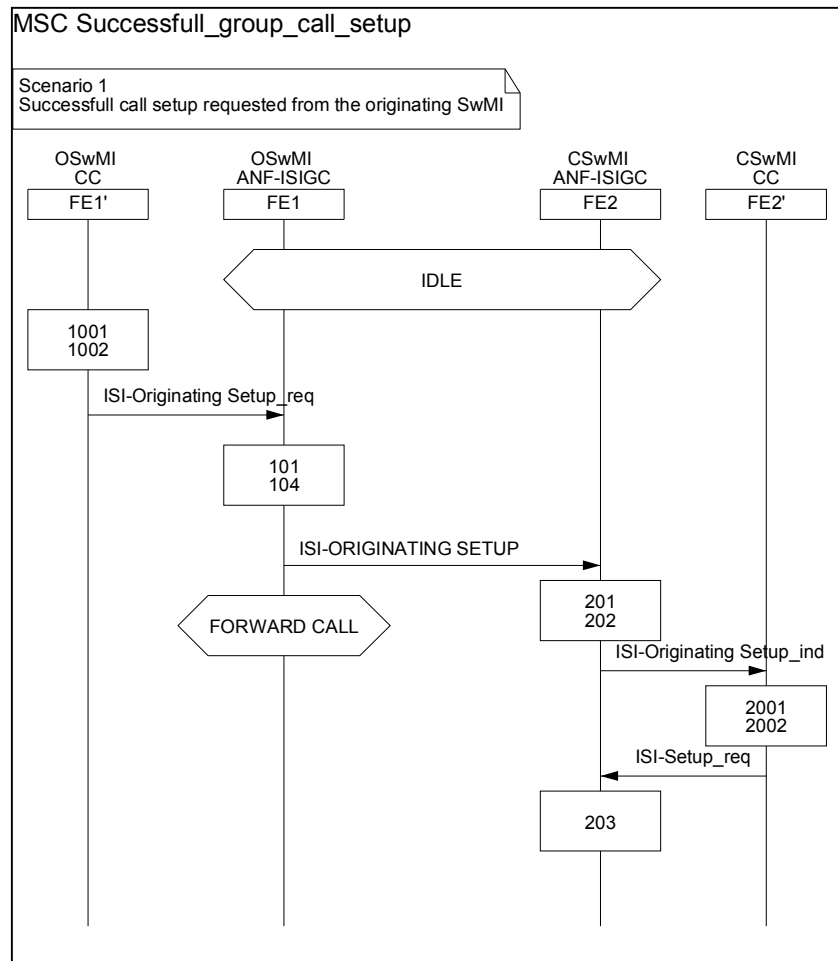

Figure 5.3: Information flow sequence - successful group call set-up, scenario 1 (sheet 1 of 3)

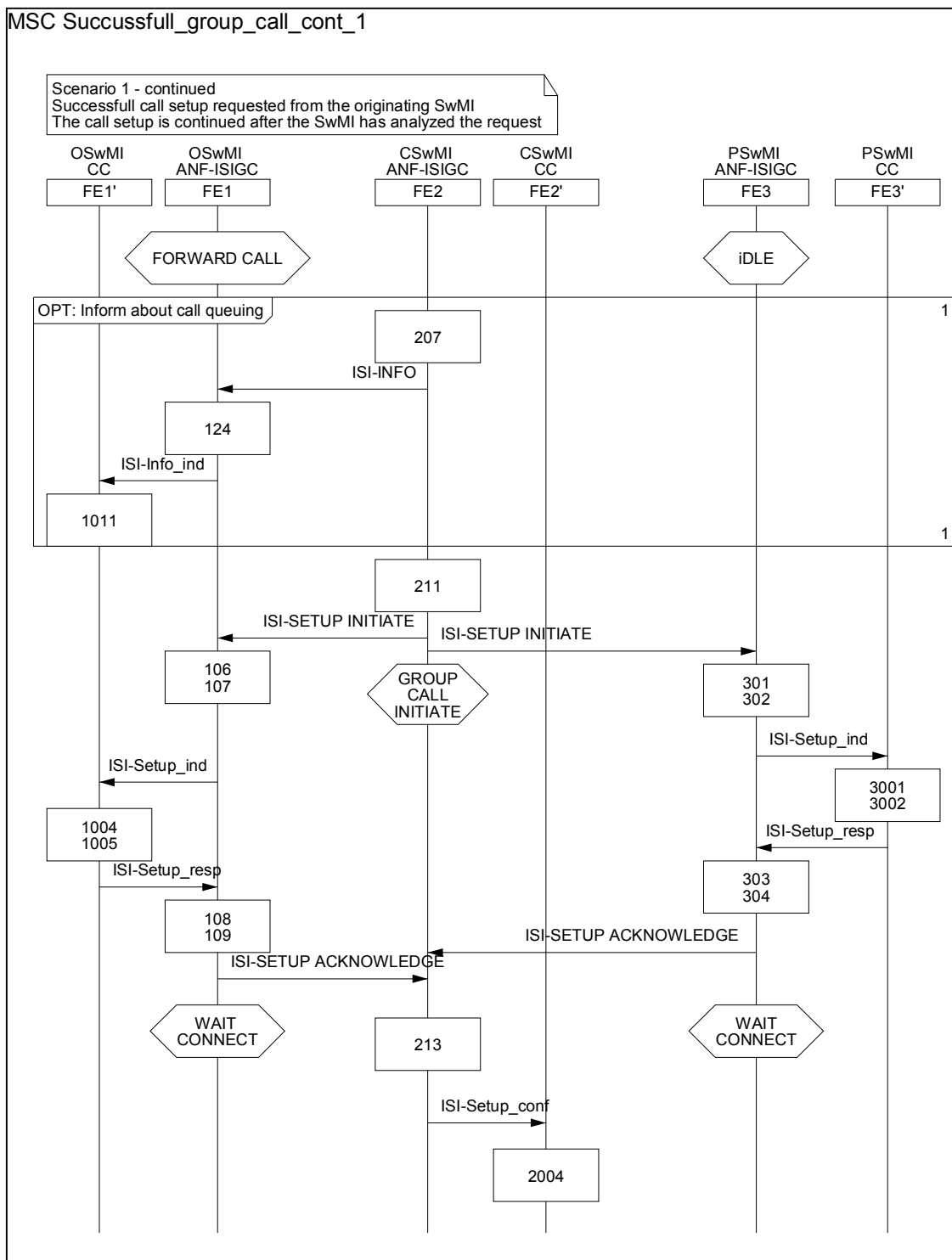

Figure 5.4: Information flow sequence - successful group call set-up, scenario 1 (sheet 2 of 3)

FE2 shall inform FE1 and FE3 of "Setup response time-out" after reception of an ISI-ORIGINATING SETUP. The "Setup response time-out" shall be used to inform the originating SwMI and participating SwMIs of the call set-up time used by the controlling SwMI. The "Setup response time-out" shall be contained within the information flow ISI-Setup.

FE2 may inform FE1 of "call time-out, set-up phase" after reception of an ISI-ORIGINATING SETUP. The "call time-out, set-up phase" may be used to inform the originating SwMI of the call set-up time used by the controlling SwMI. The "call time-out, set-up phase" shall be contained within the information flow ISI-INFO.

FE2 may inform FE1 of the "call status" after reception of an ISI-ORIGINATING SETUP. The "call status" should be used to inform FE1 of a possible queuing of the ISI-ORIGINATING SETUP within the controlling SwMI. The "call status" shall be contained within the information flow ISI-INFO.

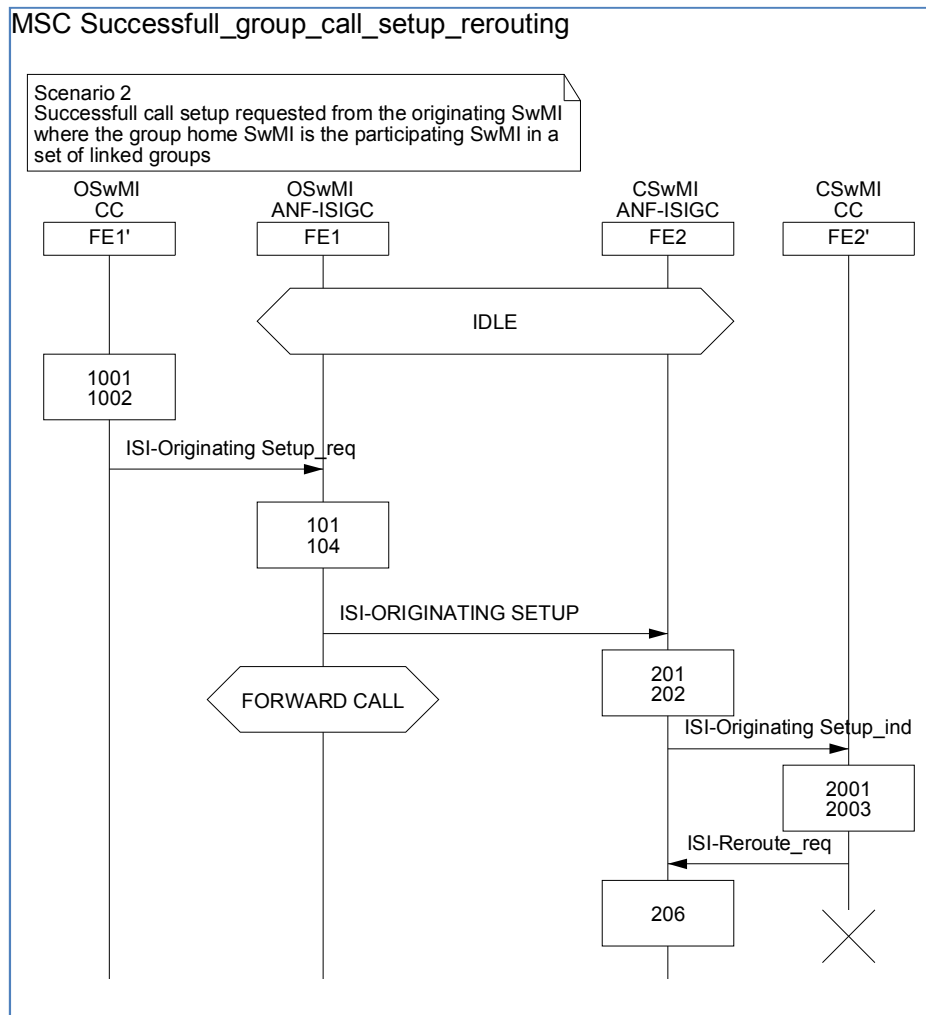

Figure 5.6: Information flow sequence - successful group call set-up, scenario 2 (sheet 1 of 4)

MSC Successful_group_call_set-up_rerouting

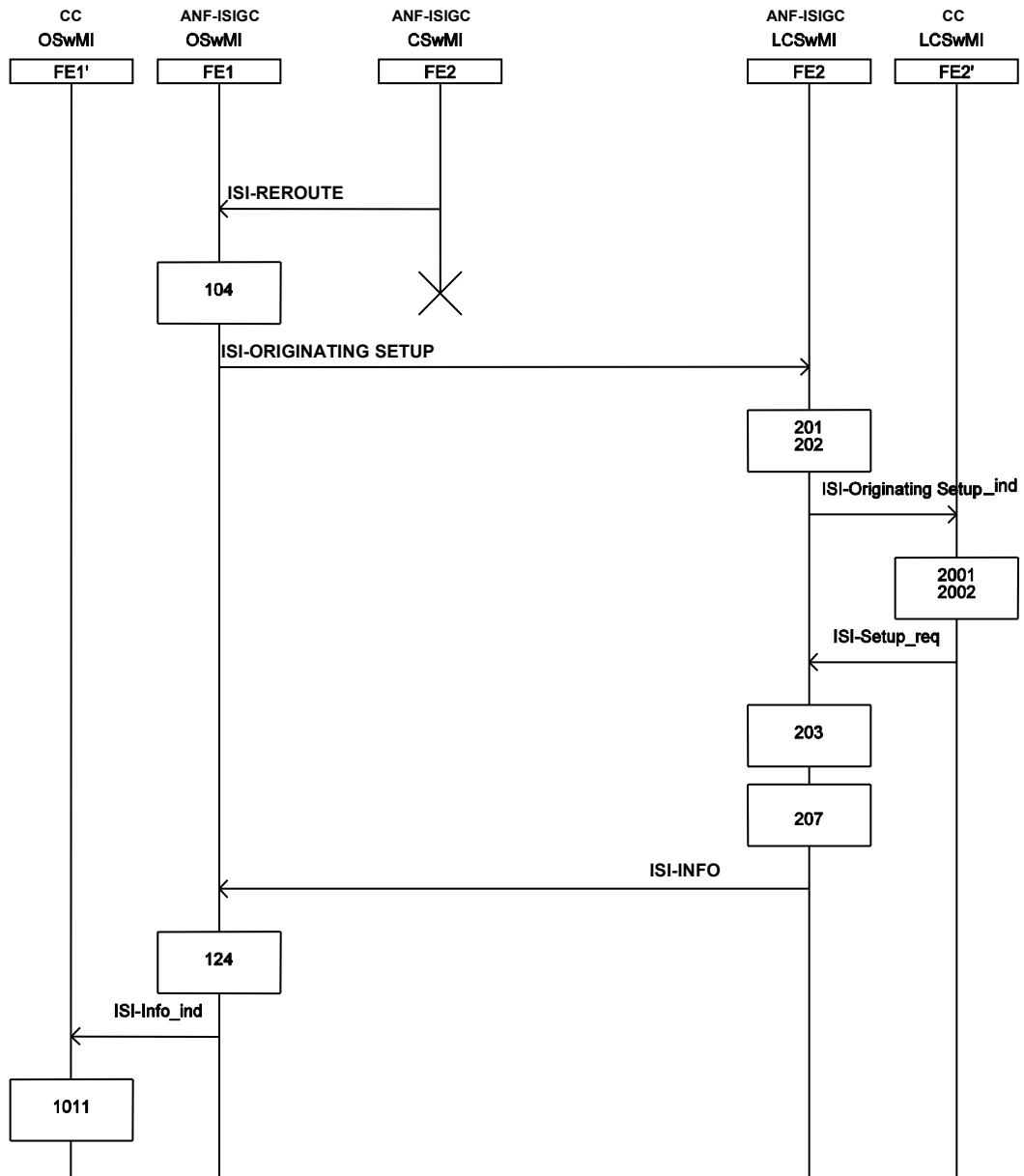

Figure 5.7: Information flow sequence - successful group call set-up, scenario 2 (sheet 2 of 4)

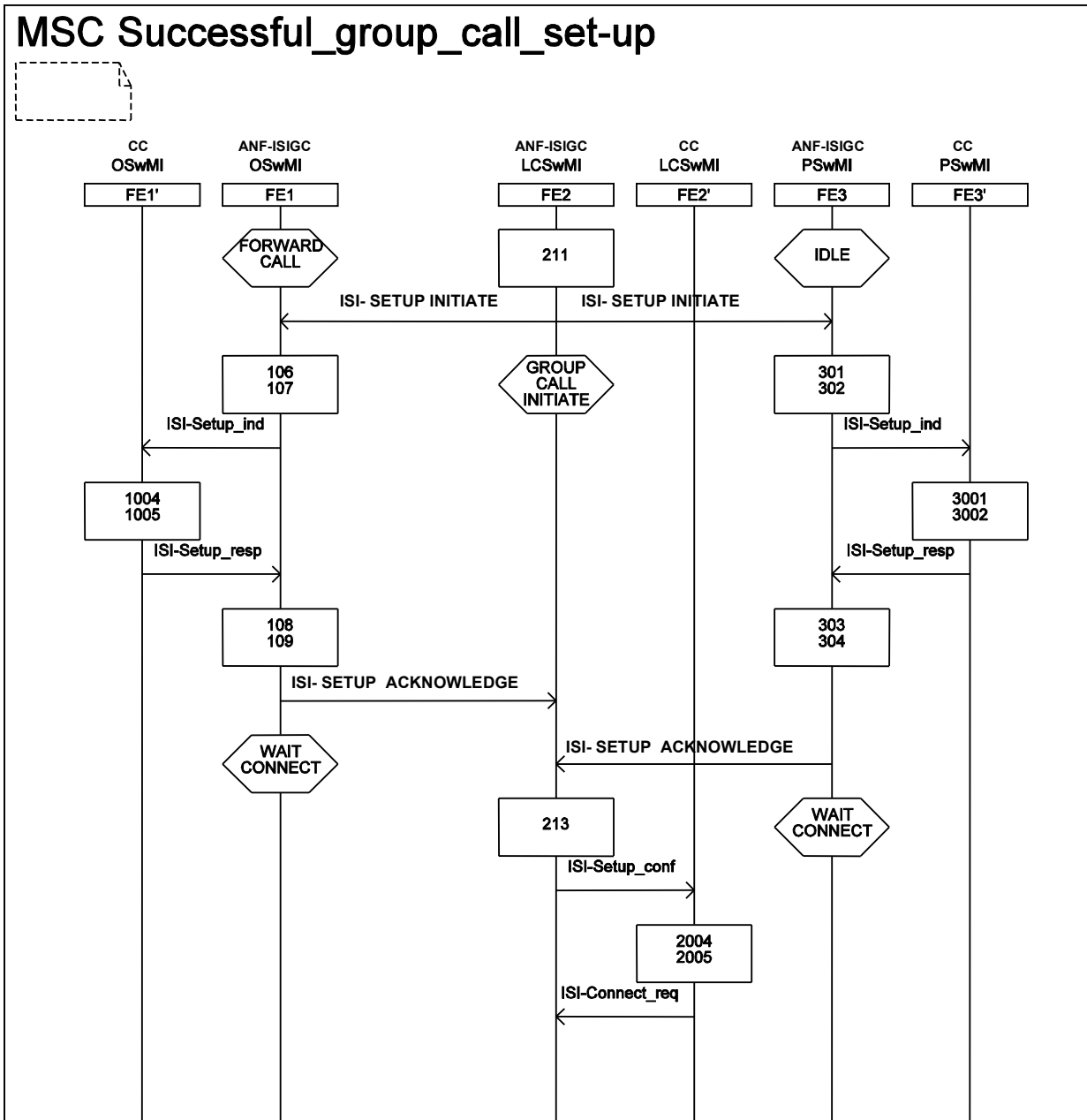

Figure 5.8: Information flow sequence - successful group call set-up, scenario 2 (sheet 3 of 4)

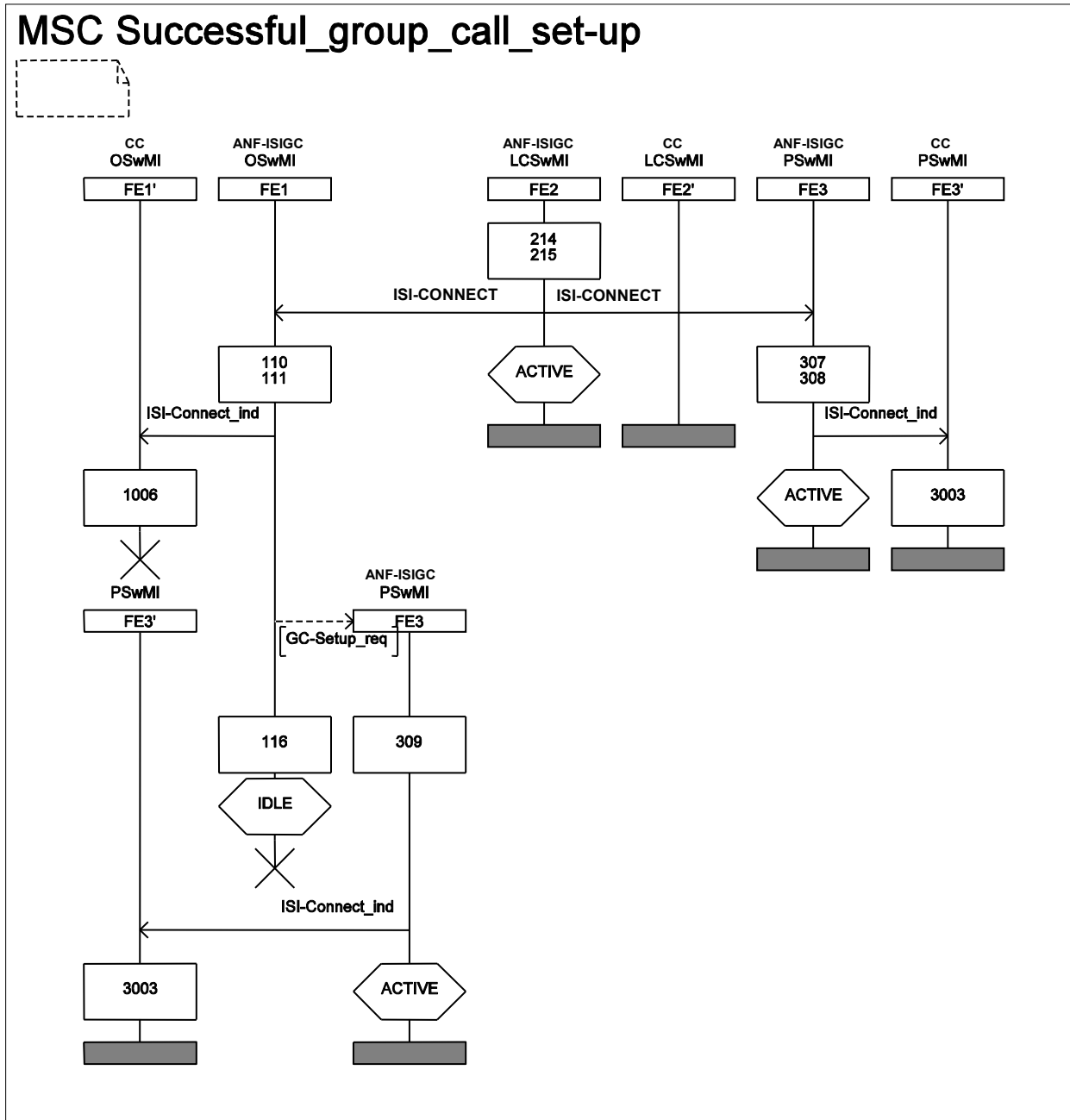

Figure 5.9: Information flow sequence - successful group call set-up, scenario 2 (sheet 4 of 4)

FE2 shall inform FE1 and FE3 of "Setup response time-out" after reception of an ISI-ORIGINATING SETUP. The "Setup response time-out" shall be used to inform the originating SwMI and participating SwMIs of the call set-up time used by the controlling SwMI. The "Setup response time-out" shall be contained within the information flow ISI-Setup.

FE2 may inform FE1 of "call time-out, set-up phase" after reception of an ISI-ORIGINATING SETUP. The "call time-out, set-up phase" may be used to inform the originating SwMI of the call set-up time used by the controlling SwMI. The "call time-out, set-up phase" shall be contained within the ISI-INFO.

FE2 may inform FE1 of the "call status" after reception of an ISI-ORIGINATING SETUP. The "call status" should be used to inform FE1 of a possible queuing of the ISI-ORIGINATING SETUP within the controlling SwMI. The "call status" shall be contained within the ISI-INFO.

5.2.1.3 Acknowledged group call set-up over ISI using ANF-ISIGC

For acknowledged group calls, participating SwMIs shall first be polled after the group call has been successfully set-up. The group call set-up sequence for acknowledged group calls shall comply to the set-up sequences shown in figures 5.3 to 5.9.

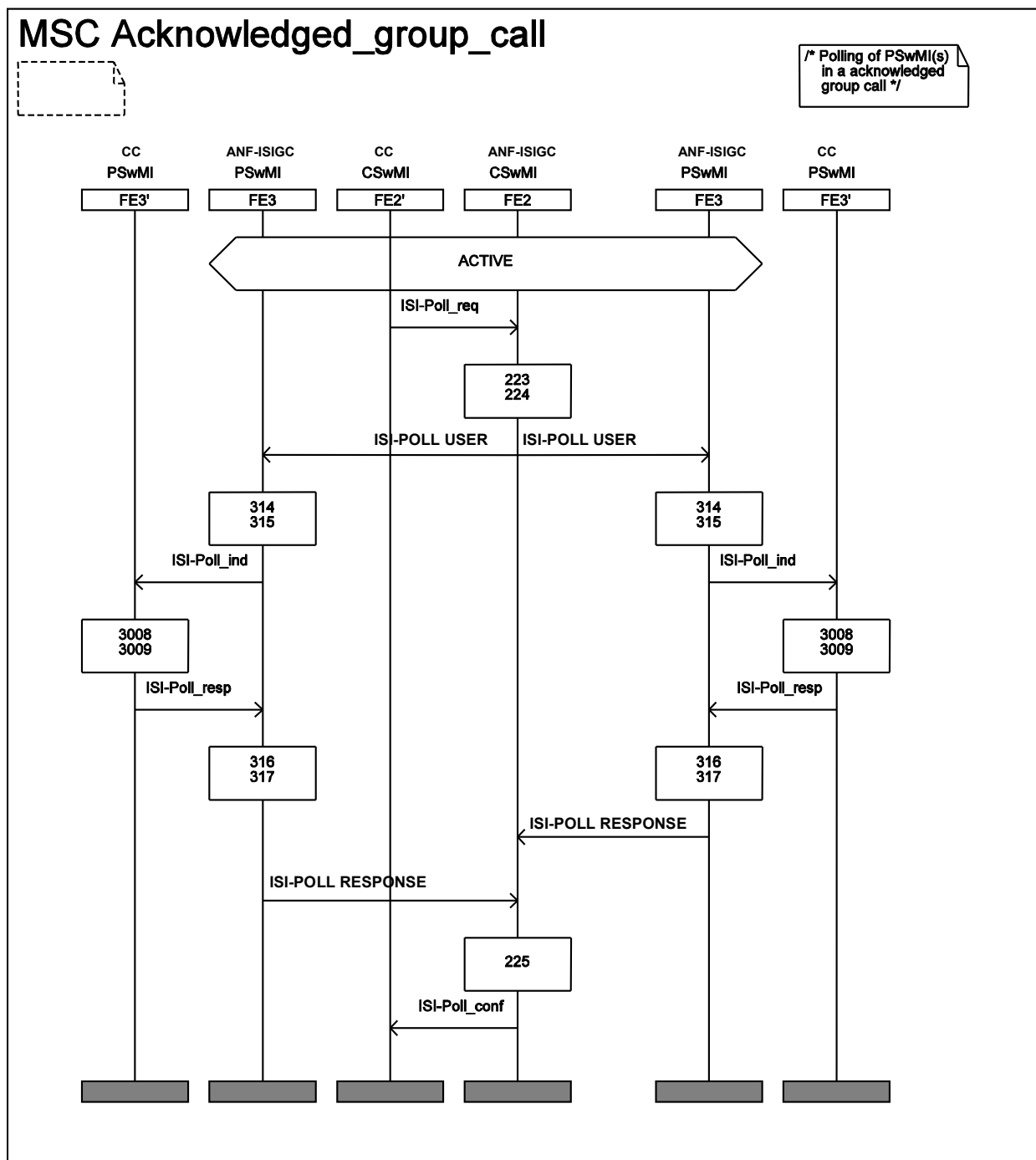

Figure 5.10: Information flow sequence - successful acknowledged group call set-up

5.2.1.4 Partial group call set-up over ISI using ANF-ISIGC

The group call has been initiated as shown for case scenarios 1 and 2, figure 5.3 and figure 5.6. The controlling SwMI determines that the call setup shall continue even though the participating SwMI has indicated that it need more time to find resources for the call.

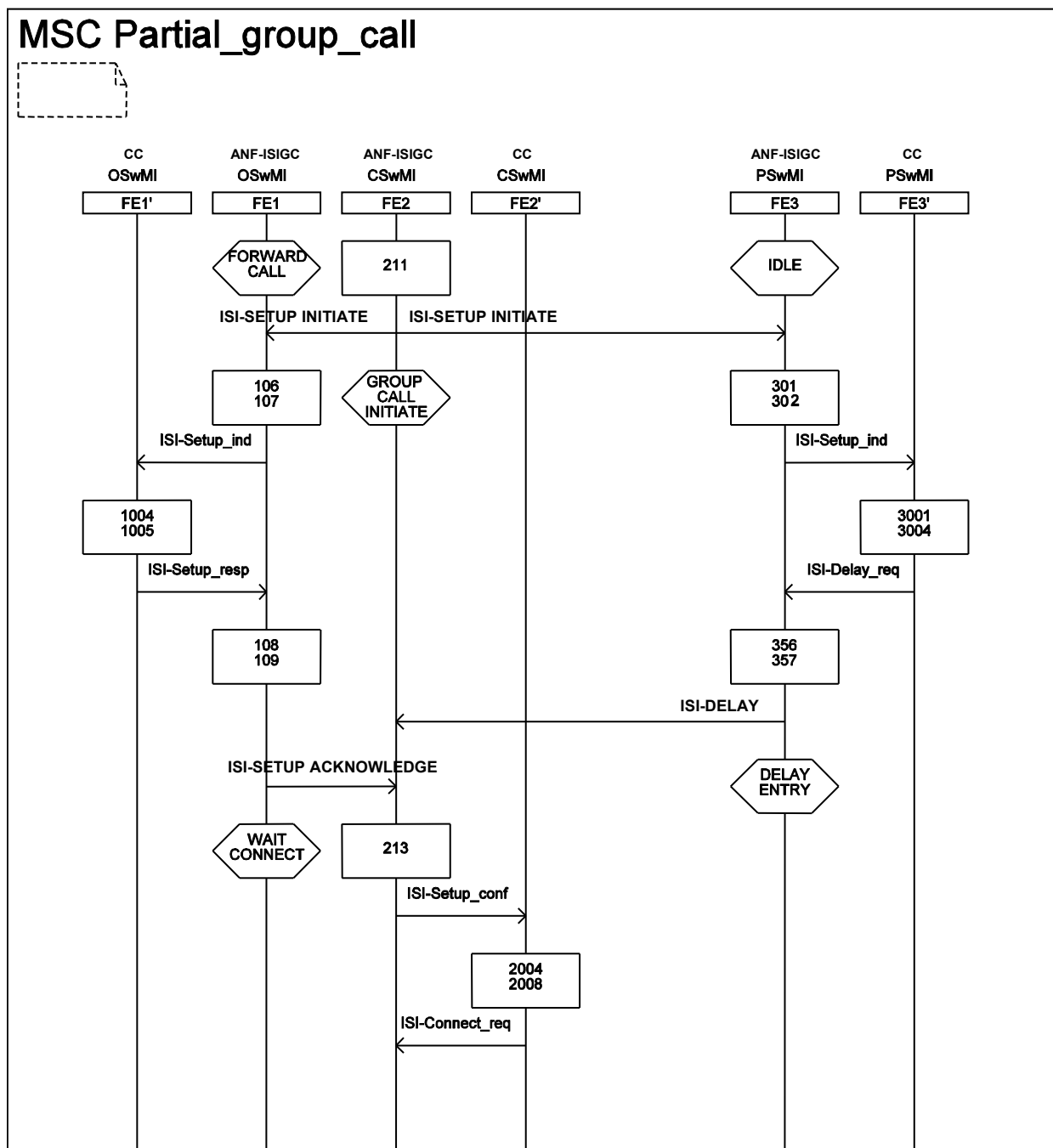

Figure 5.11: Information flow sequence - partial group call set-up (sheet 1 of 3)

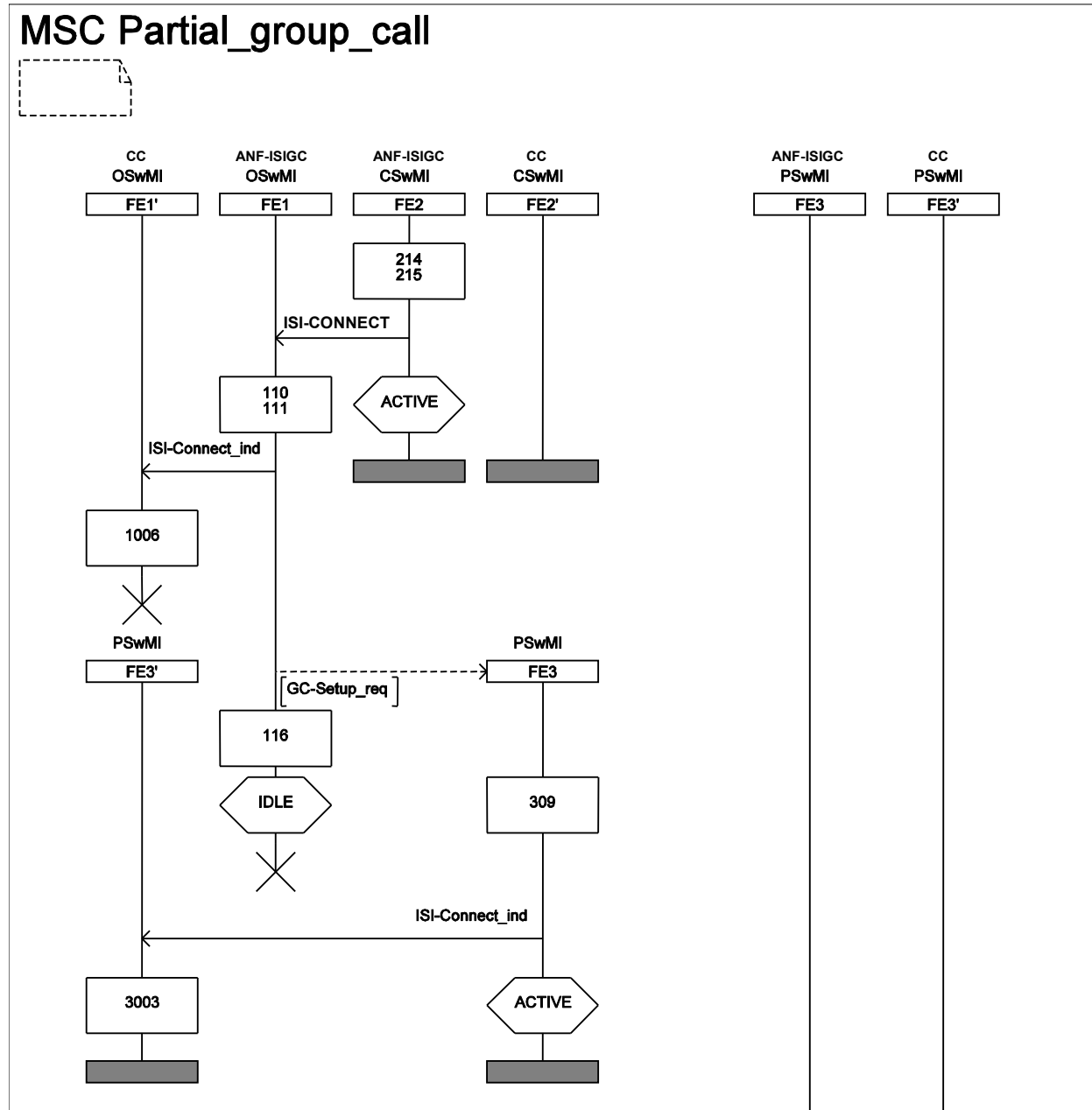

Figure 5.12: Information flow sequence - partial group call set-up (sheet 2 of 3)

When the participating SwMI obtains resources it informs the controlling SwMI and is included in the call.

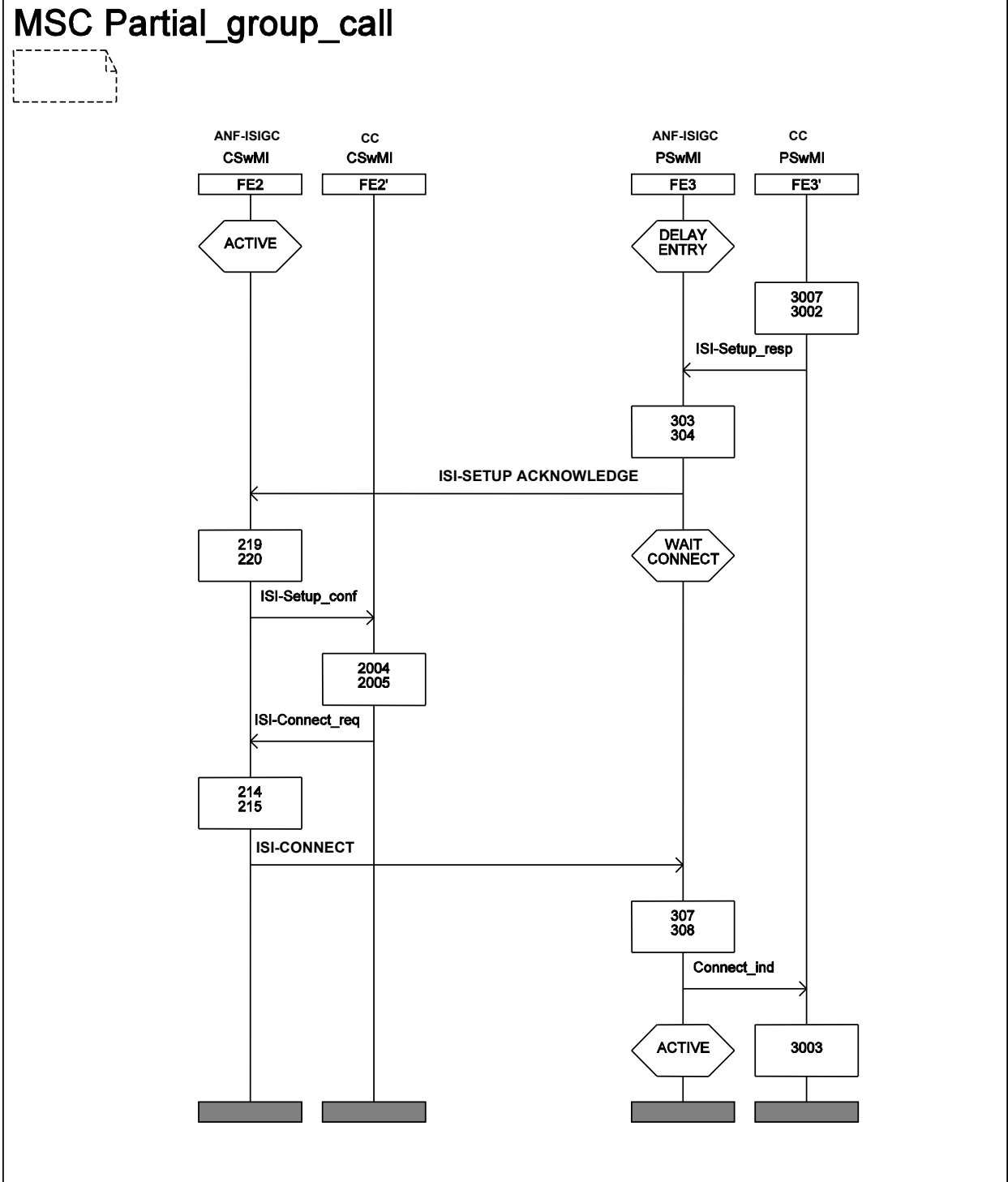

Figure 5.13: Information flow sequence - partial group call set-up (sheet 3 of 3)

5.2.1.5 Delay of group call set-up over ISI using ANF-ISIGC

The group call has been initiated as shown for case scenarios 1 and 2, figure 5.3 and figure 5.6. The originating SwMI has indicated that it uses temporary resource allocation. That means that the controlling SwMI can allow the OSwMI to release its resources while waiting for resources in another SwMI if the controlling SwMI determines that the call cannot continue without the participating SwMI.

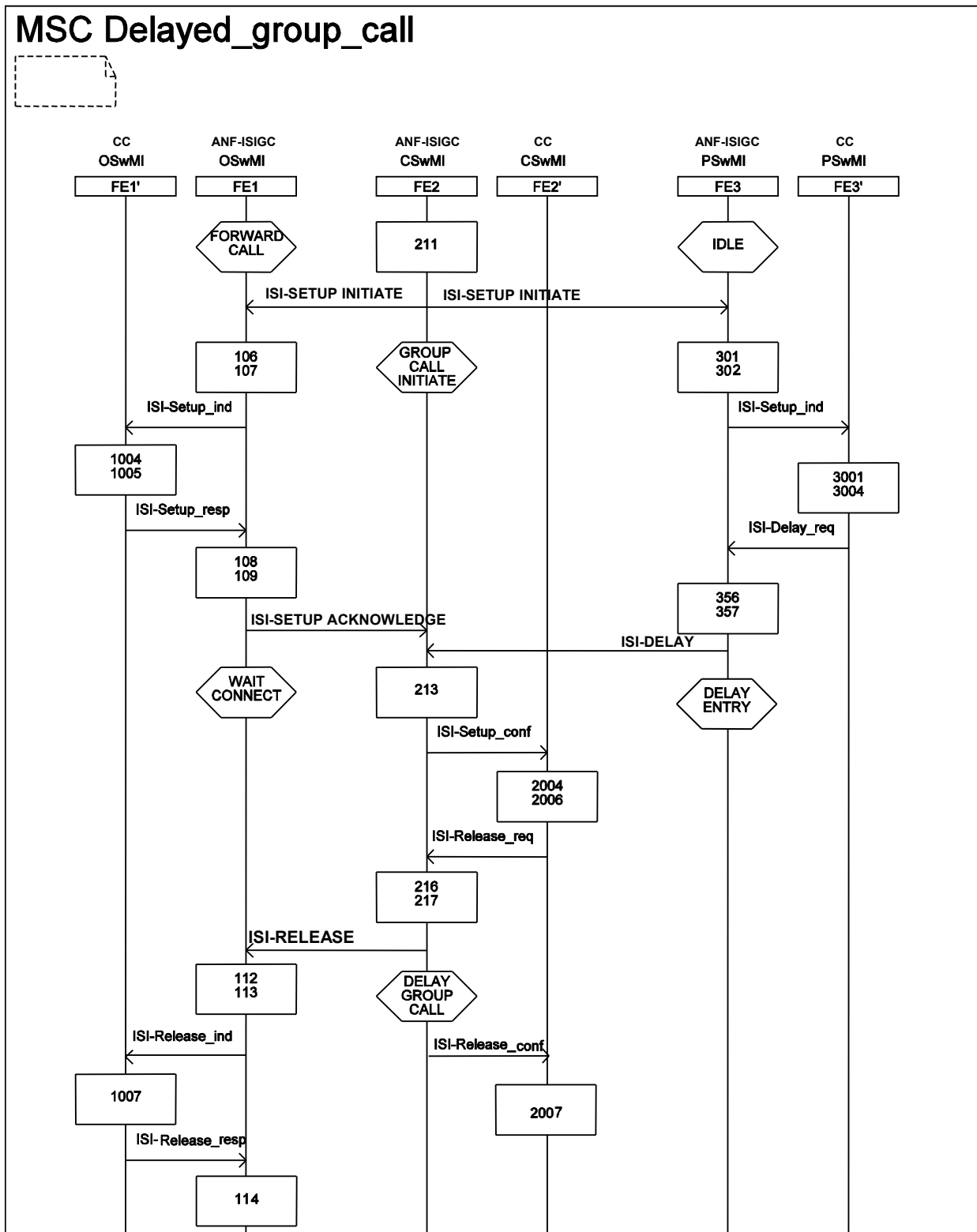

Figure 5.14: Information flow sequence - delayed group call set-up (sheet 1 of 3)

When the participating SwMI indicates that resources are available the originating SwMI will be informed with an ISI-Setup.

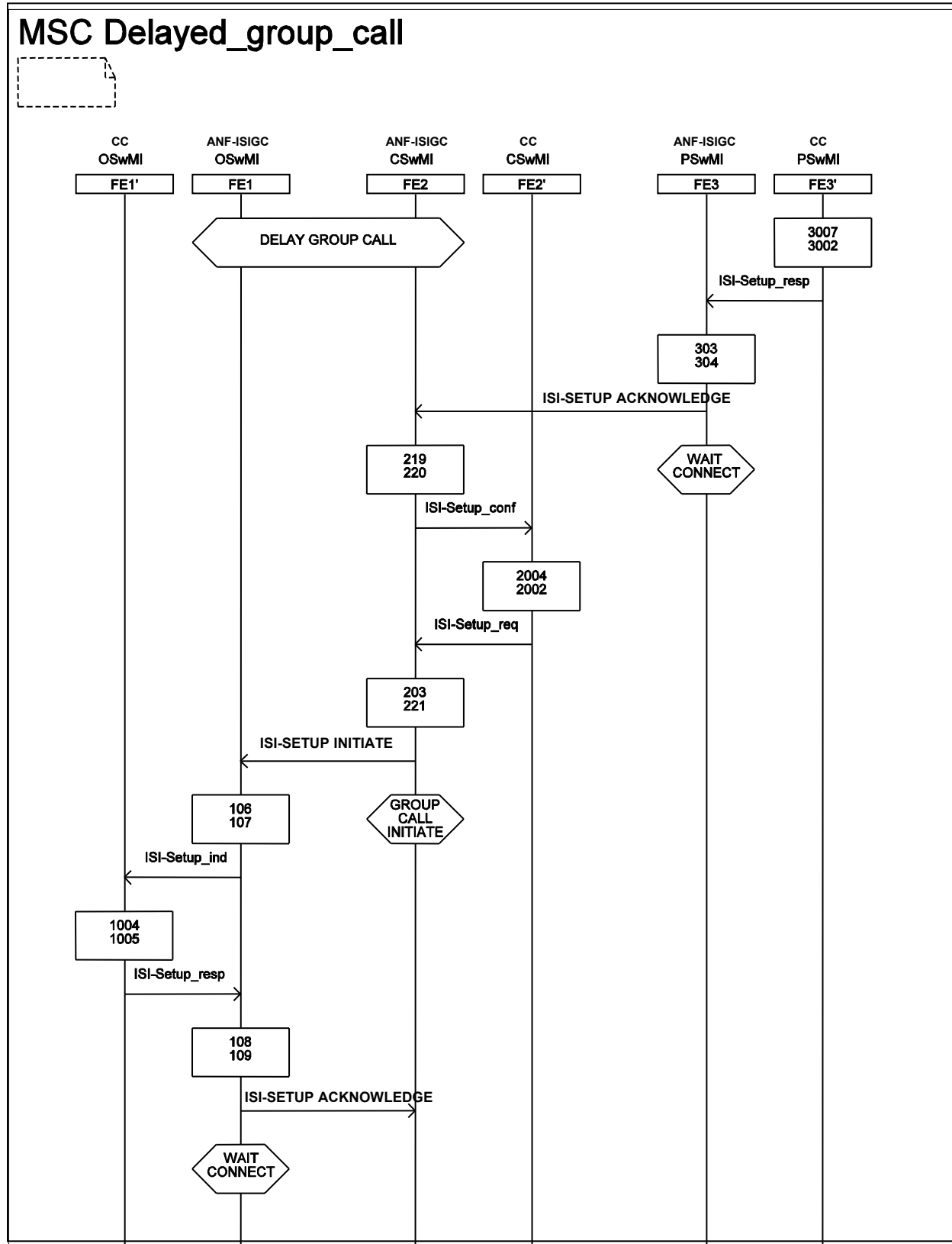

Figure 5.15: Information flow sequence - delayed group call set-up (sheet 2 of 3)

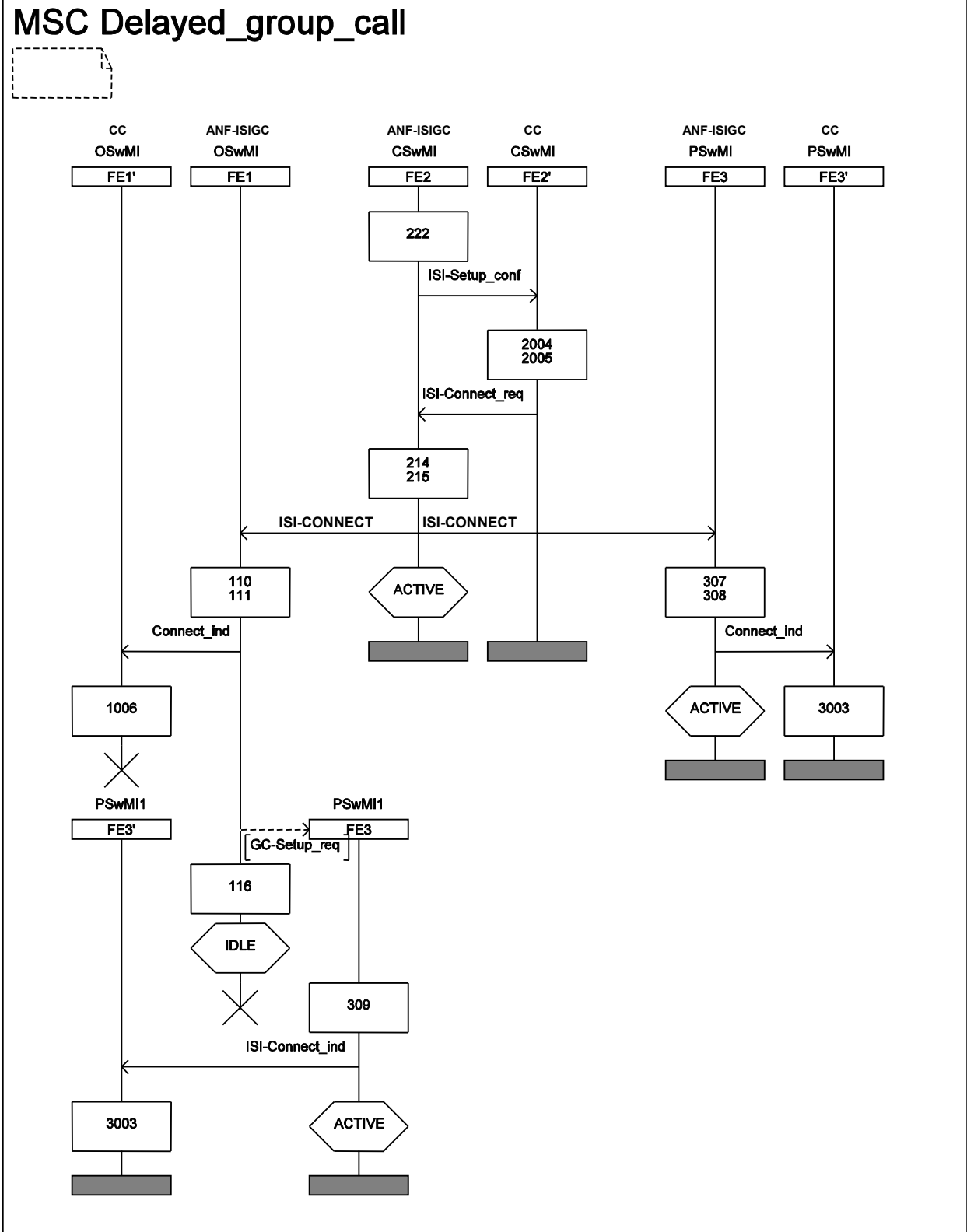

Figure 5.16: Information flow sequence - delayed group call set-up (sheet 3 of 3)

5.2.1.6 Interaction with an active group call

Figures 5.17 and 5.18 show the information flow when an individual TETRA user makes a call to a group already active in a call. Upon acceptance from the controlling SwMI call control application, the invoked ANF-ISIGC entity shall be merged into the call.

If the active call is an inter-TETRA call then the invoked ANF-ISIGC entity shall be merged with the ANF-ISIGC entity for the active call.

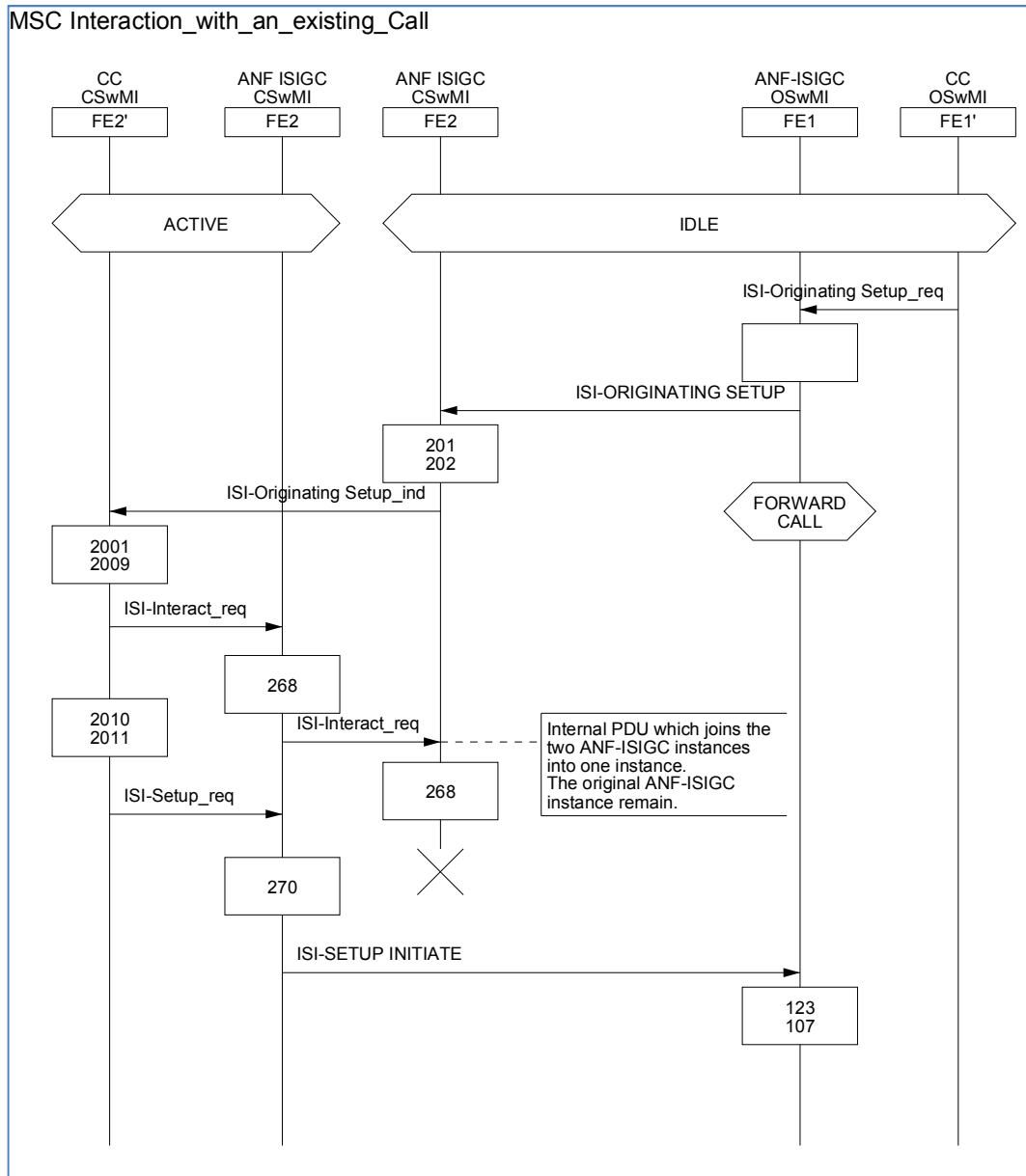

Figure 5.17: Information flow sequence - Interaction with active ANF-ISIGC (sheet 1 of 2)

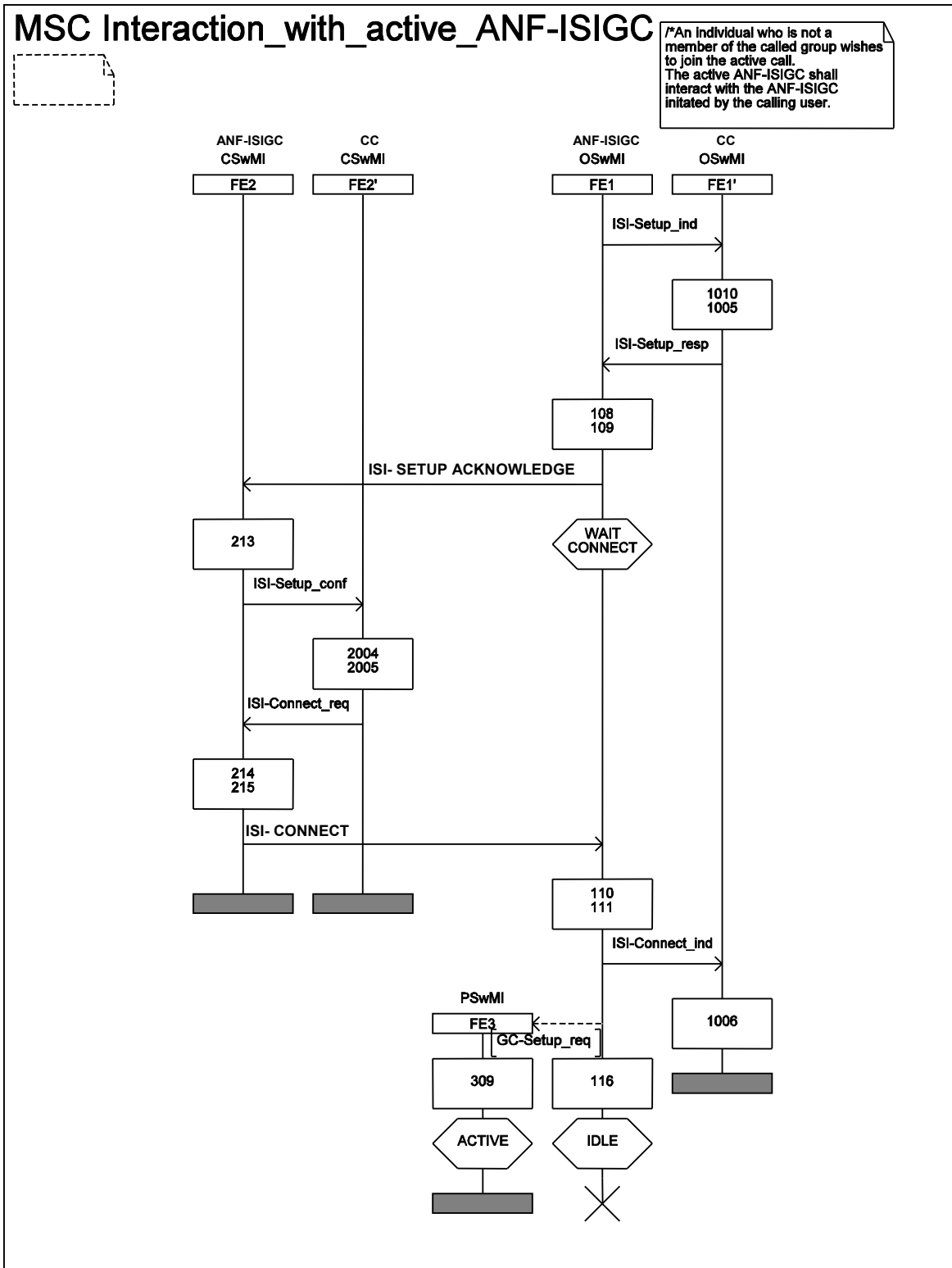

Figure 5.18: Information flow sequence - Interaction with active ANF-ISIGC (sheet 2 of 2)

5.2.1.7 Unsuccessful group call set-up over ISI using ANF-ISIGC

Figures 5.19 to 5.20 show the information flow sequence for an unsuccessful group call set-up using ANF-ISIGC. The unsuccessful scenarios cover those cases from clause 4.2.2.3.2 where of call rejection is done by the controlling SwMI, group home SwMI or participating SwMI.

MSC UnSuccessful_group_call_set-up

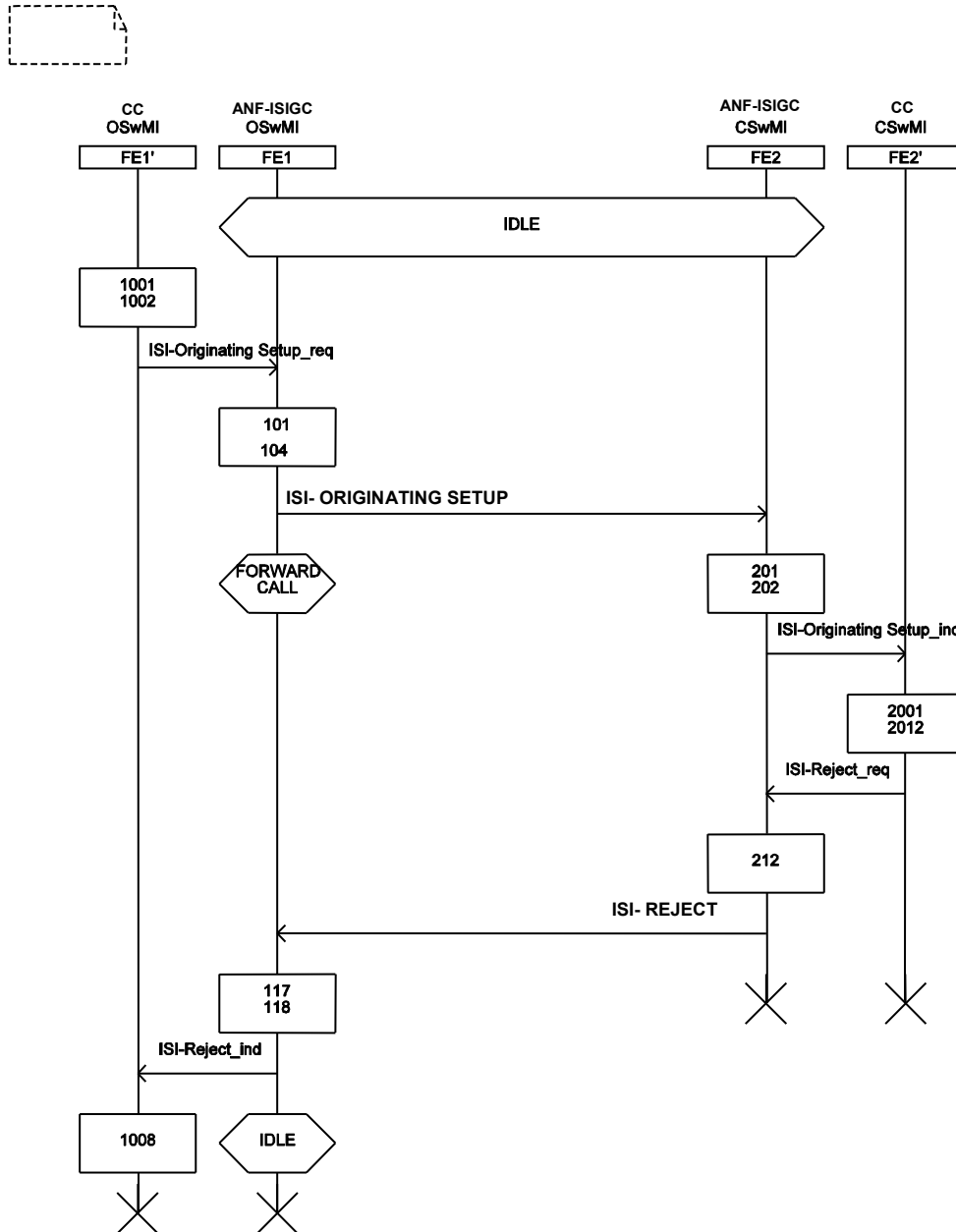

Figure 5.19: Information flow sequence - group home SwMI rejects the call

Figure 5.20 contains the case where the participating SwMI does not want to participate in the call and the ISI call is cleared. The call might continue in the originating SwMI, the controlling SwMI and other participating SwMIs or it might release the call as shown in figure 5.20.

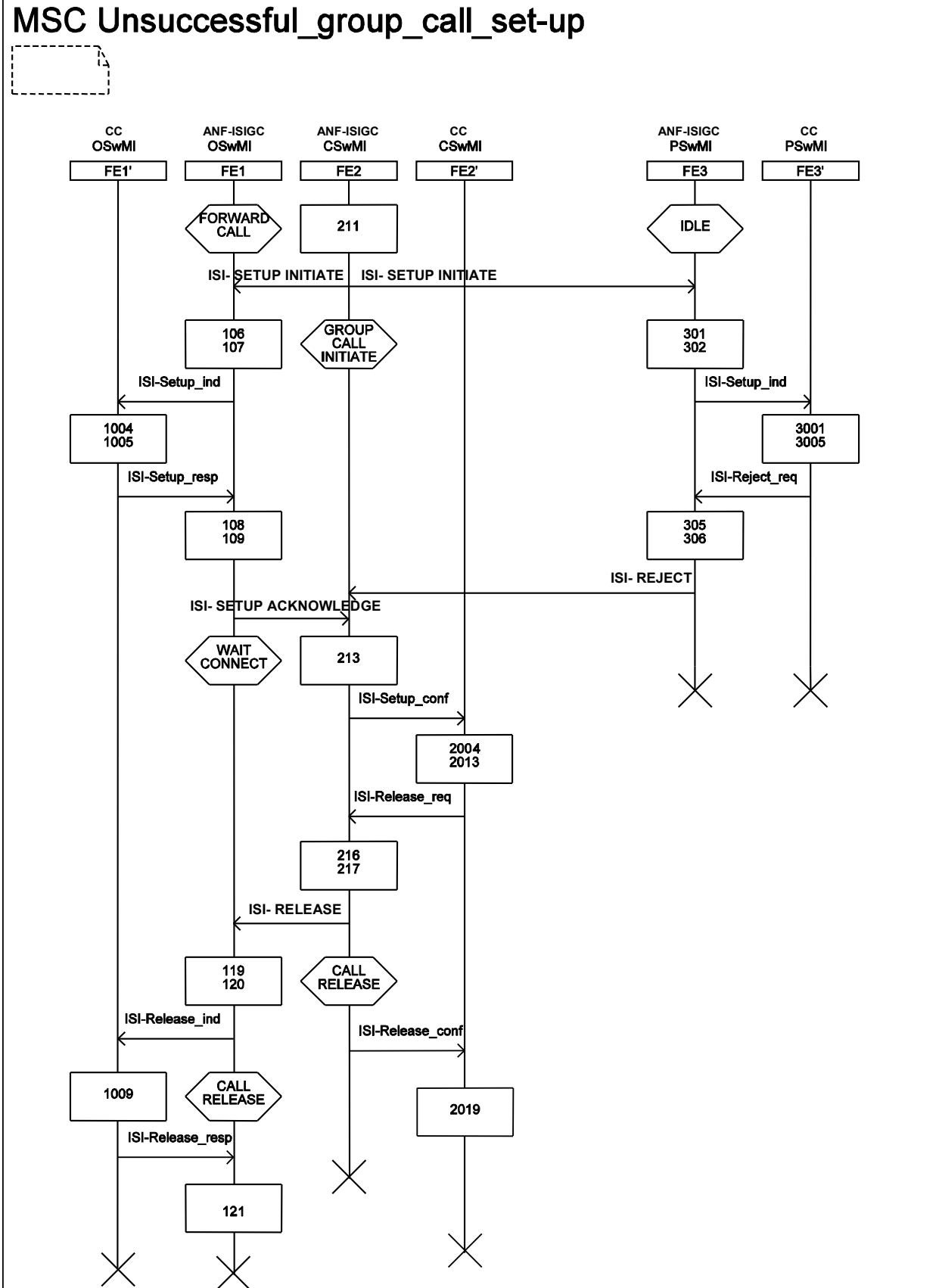

Figure 5.20: Information flow sequence - controlling SwMI releases the call

5.2.1.8 Call Maintenance procedures - Request to transmit

Figure 5.21 shows the information flow sequence for a request to transmit from a TETRA user in a participating SwMI and the possible resource request and transmission granting responses from the controlling SwMI. All participating SwMIs involved in the call shall receive a group addressed ISI-TX_GRANTED PDU when transmission has been granted to a user. In this case both PSwMIs has temporary resource allocation.

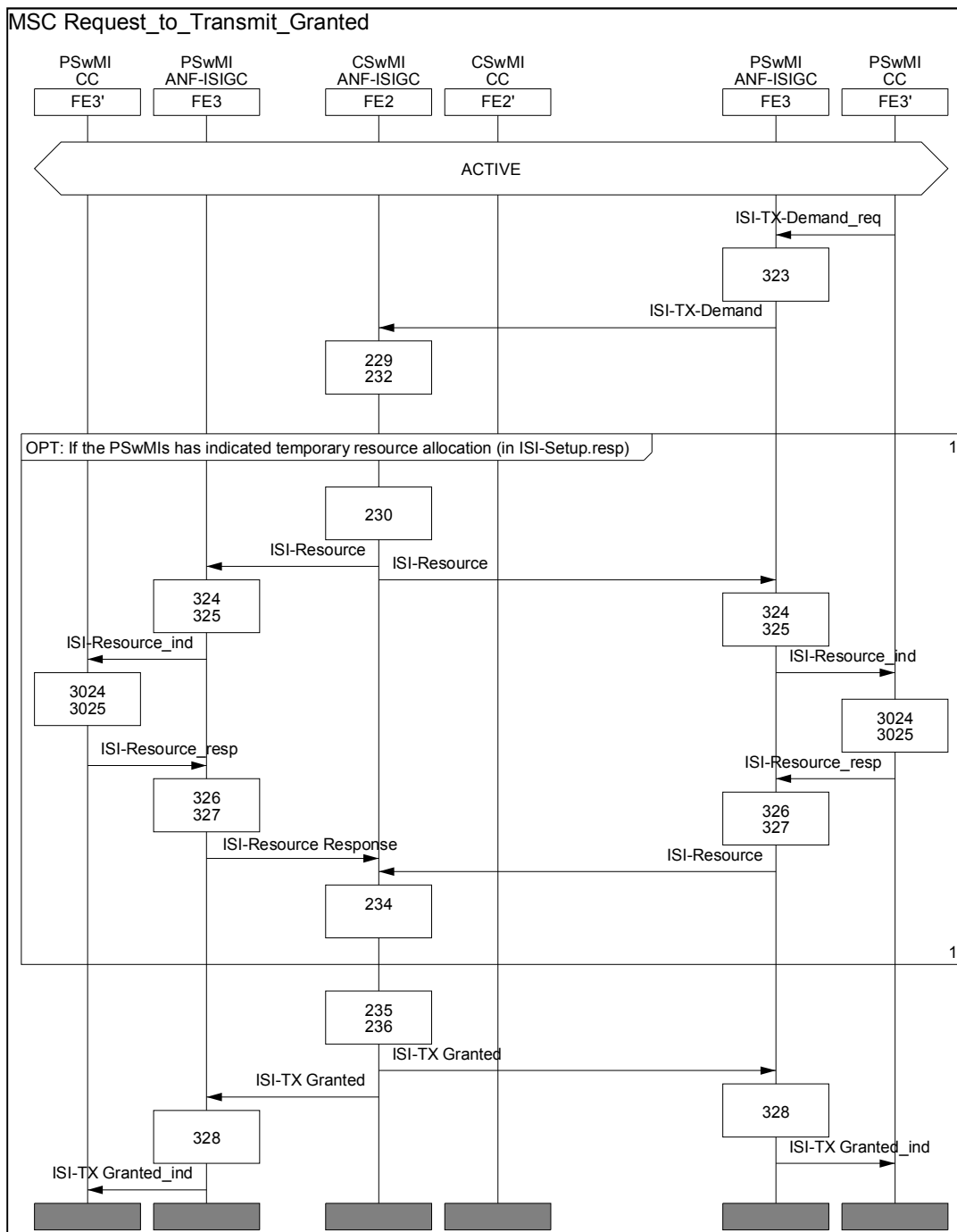

Figure 5.21: Information flow sequence - Request to transmit from participating SwMI

In case more PSwMIs have temporary resource allocation these SwMIs are requested for resources in parallel and the ISI-TX-Granted is not sent before all PSwMIs have responded to the resource allocation. It is the decision of the controlling SwMI if the transmission request shall be granted to the requester if another participating SwMI does not have the required resources.

Figure 5.22 shows that new SwMI (PSwMI2)) is included into the call using a late entry procedure triggered by a request for transmission.

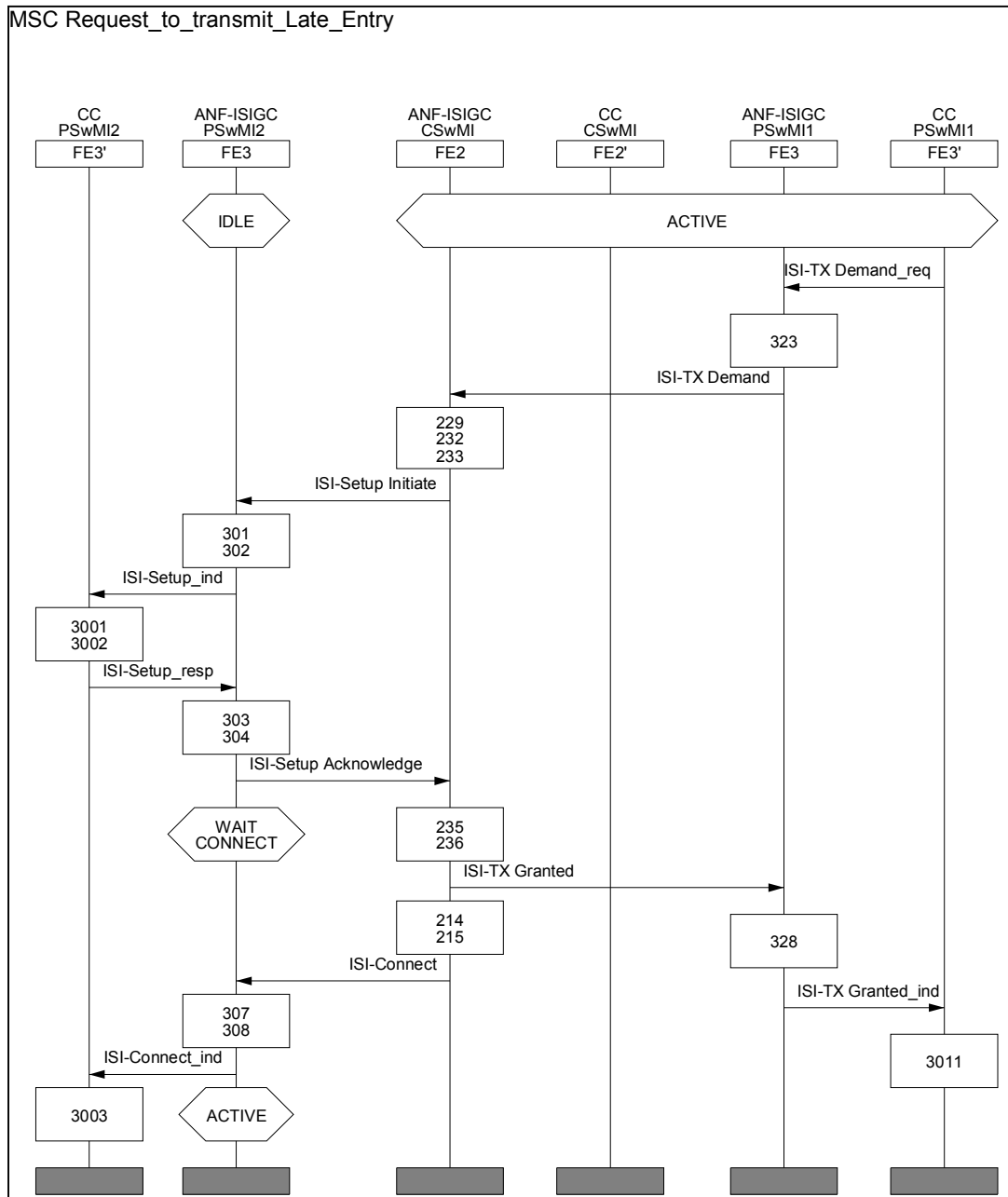

Figure 5.22: Information flow sequence - Request to transmit from participating SwMI

Figure 5.23 shows the information flow sequence for a request to transmit from a TETRA user in a participating SwMI. The transmission request is queued by the controlling SwMI.

MSC Request_to_Transmit_Queued

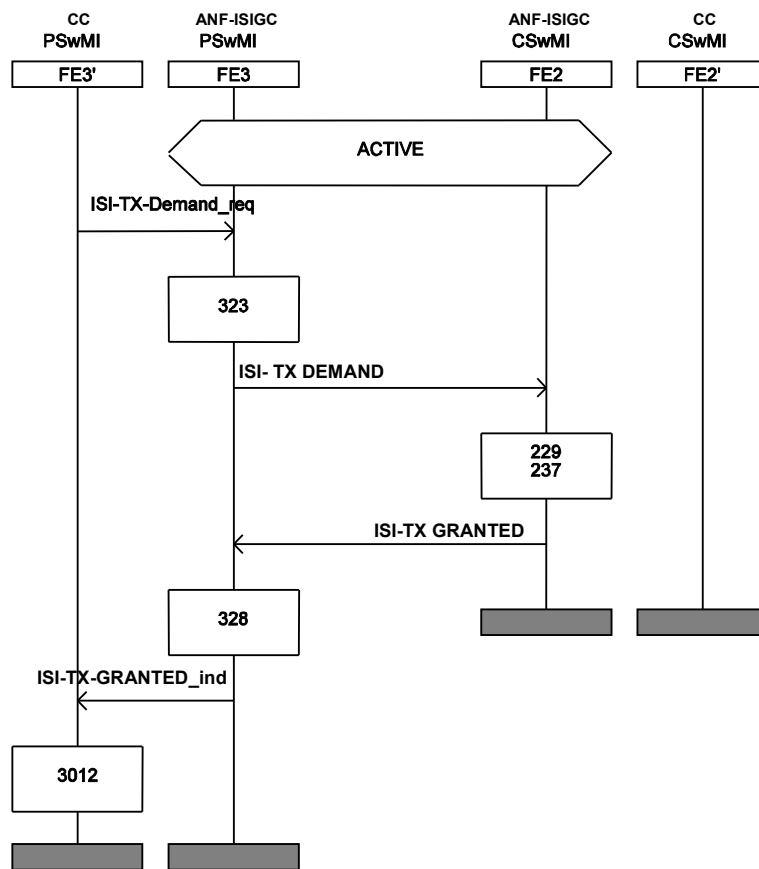

Figure 5.23: Information flow sequence - Request to transmit queued

Figures 5.24 and 5.25 show the information flow sequence for a request to transmit from a TETRA user in a participating SwMI. Both participating SwMIs supports temporary resource allocation. The transmission request is delayed due to lack of resources in the requesting PSwMI.

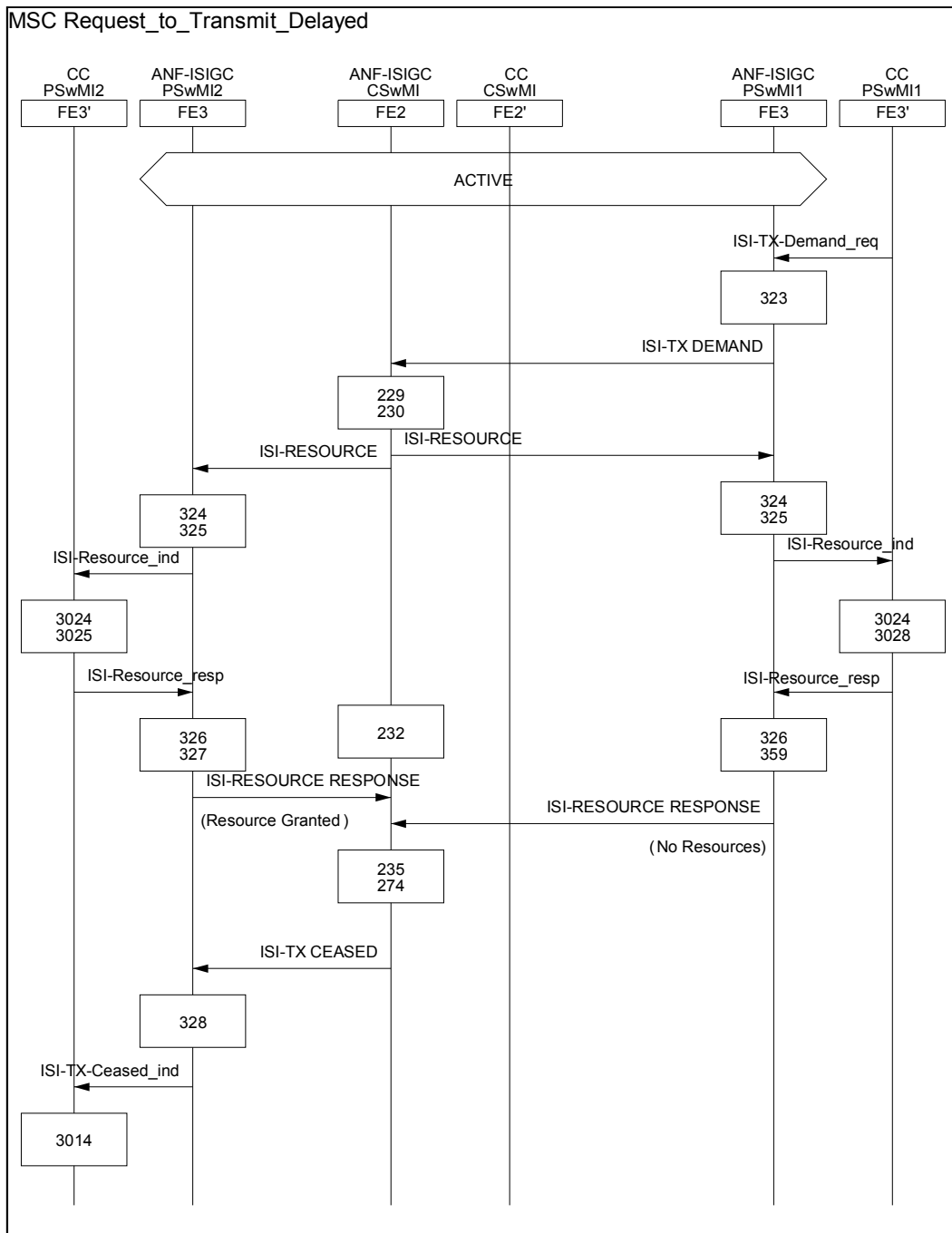

Figure 5.24: Information flow sequence - Request to transmit delayed (sheet 1 of 2)

Figure 5.26 shows the information flow sequence for a request to transmit from a TETRA user in a participating SwMI. The transmission request is rejected by the controlling SwMI.

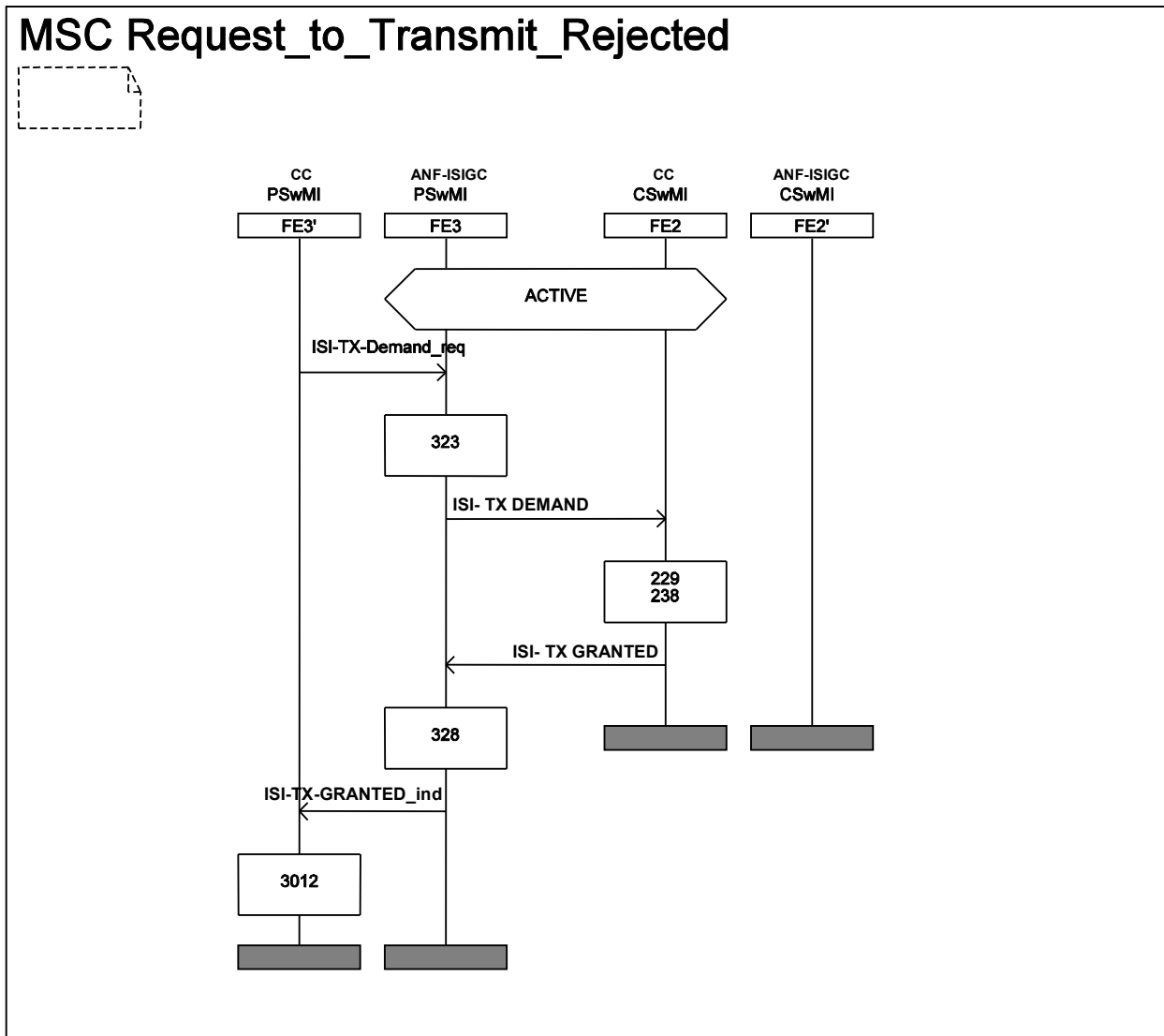

Figure 5.26: Information flow sequence - Request to transmit rejected

Figure 5.27 shows the information flow sequence for a pre-emptive request to transmit from a TETRA user in a participating SwMI. Transmission is already granted to another user. The transmitting user is interrupted by an ISI-TX INTERRUPT PDU sent from the controlling SwMI. The ISI-TX INTERRUPT PDU shall be group addressed. The participating SwMI call control application shall upon reception of an ISI-TX INTERRUPT_ind. inform the transmitting user of interruption and inform the requesting user of granted transmission.

NOTE: All participating SwMIs participating in the call should receive information about the new granted user in a group addressed ISI-TX_INTERRUPT PDU as shown in figure 5.27.

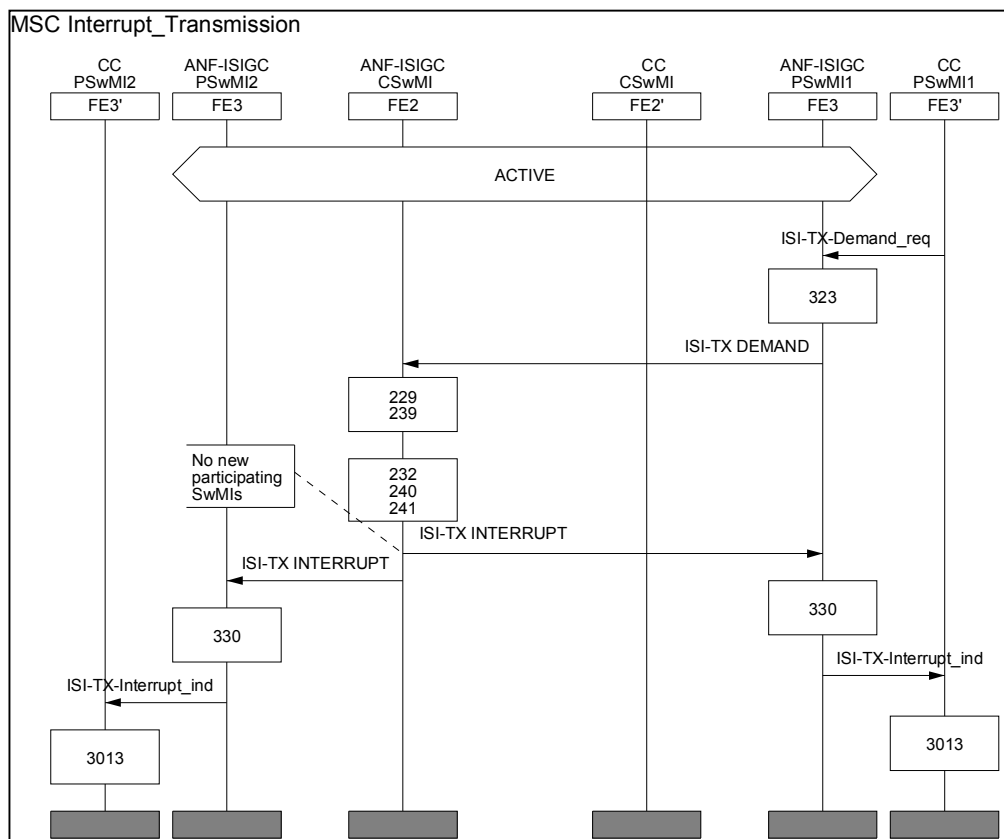

Figure 5.27: Information flow sequence - Request to transmit interrupting current transmission

If the parameter value, transmission grant in the ISI-TX_INTERRUPT PDU, is set to "transmission not granted", then an ISI-RESOURCE PDU shall be sent to all participating SwMI(s) supporting temporary resource allocation to check if resources are still available before an ISI_TX-GRANTED PDU is sent from the controlling SwMI. See figures 5.24 and 5.25 for an ISI-RESOURCE PDU sequence.

5.2.1.9 Call maintenance procedures - Cease transmission

Figures 5.28 to 5.30 show the information flow sequence for cease of transmission from a TETRA user in a participating SwMI and the possible responses from the controlling SwMI.

NOTE: All participating SwMIs participating in the call should receive information about the cease of transmission with a group addressed ISI-TX CEASED PDU as shown in figure 5.28.

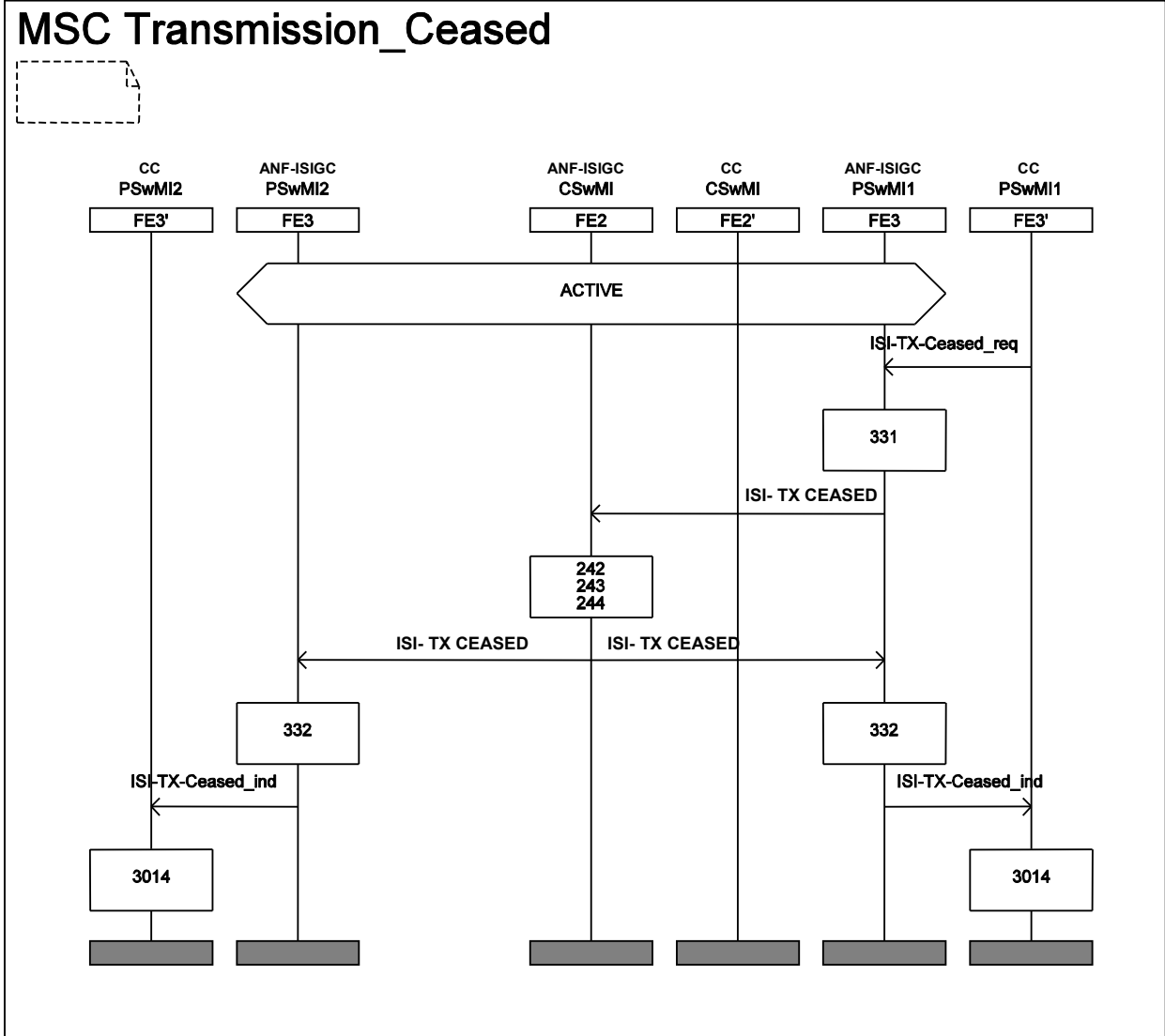

NOTE: No request has been queued by the controlling SwMI.

Figure 5.28: Information flow sequence - Request by participating SwMI to cease current transmission

Figures 5.29 and 5.30 show the information flow sequence for cease of transmission from a TETRA user in a participating SwMI. Requests to transmit have been queued in the controlling SwMI. Permission to transmit granted to first in queue.

All participating SwMIs participating in the call should receive information about the new grant of transmission by a group addressed ISI-TX GRANTED PDU as shown in figures 5.29 and 5.30. An ISI-TX CEASED PDU shall not be sent out to the active group.

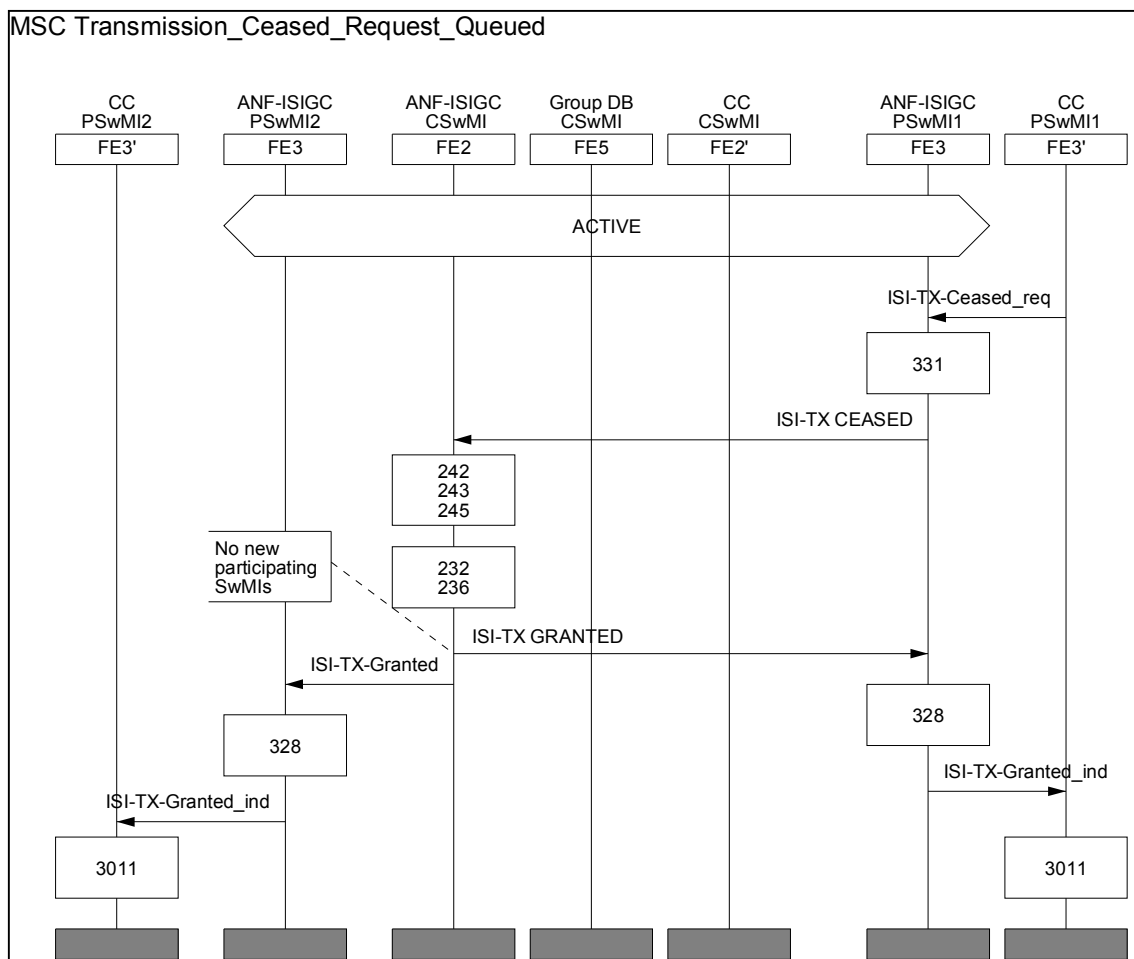

**Figure 5.29: Information flow sequence -
Permission to transmit following a cease transmission sequence**

Figure 5.30 shows the information flow sequence for a request, to withdraw a non-granted transmission request, from a TETRA user in a participating SwMI.

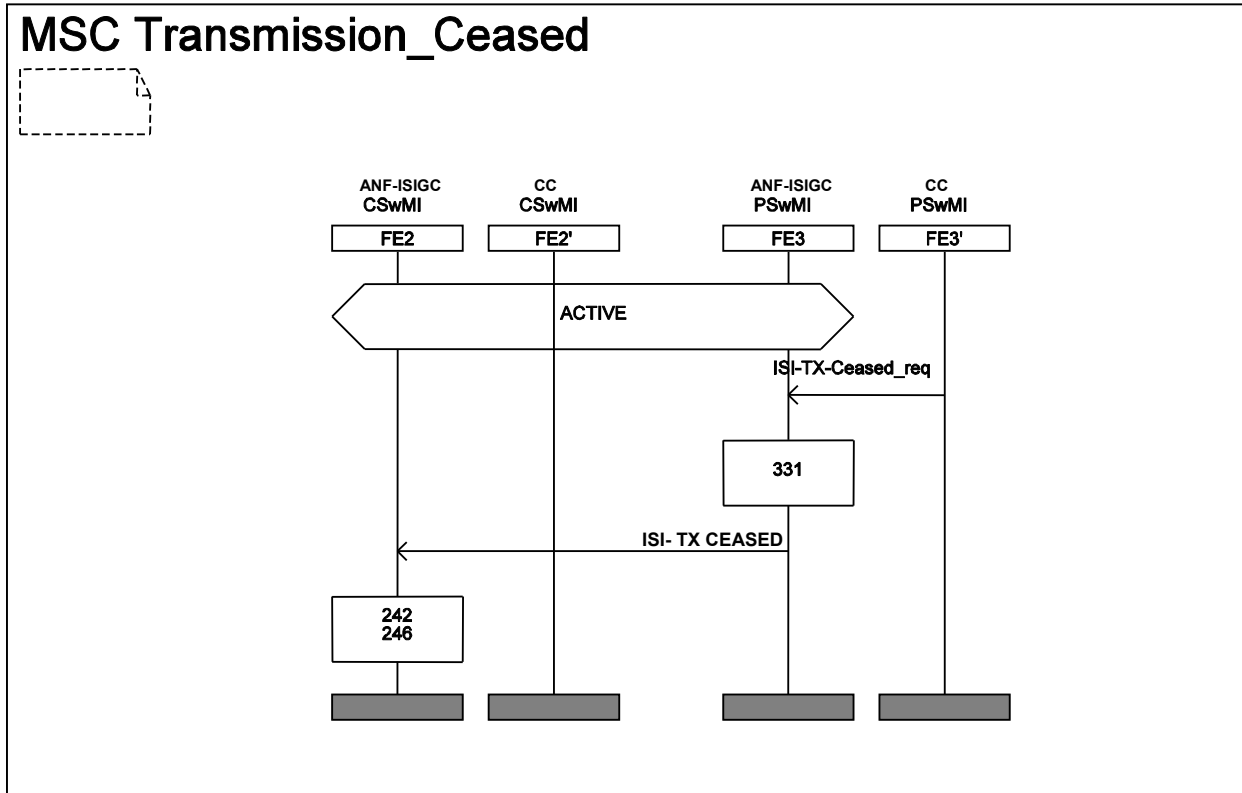

Figure 5.30: Information flow sequence - Request by participating SwMI to withdraw a transmission request

5.2.1.10 Call Maintenance procedures - Withdraw/Continue from an active group call

Figures 5.31 to 5.32 show the information flow sequence for a request, sent from a participating SwMI, to withdraw or continue from an active group call.

A participating SwMI may decide to interrupt transmission (e.g. withdraw from the call) when resources are required for another call or when the SwMI requires that the call should temporarily pause. The controlling SwMI shall be informed of withdrawal.

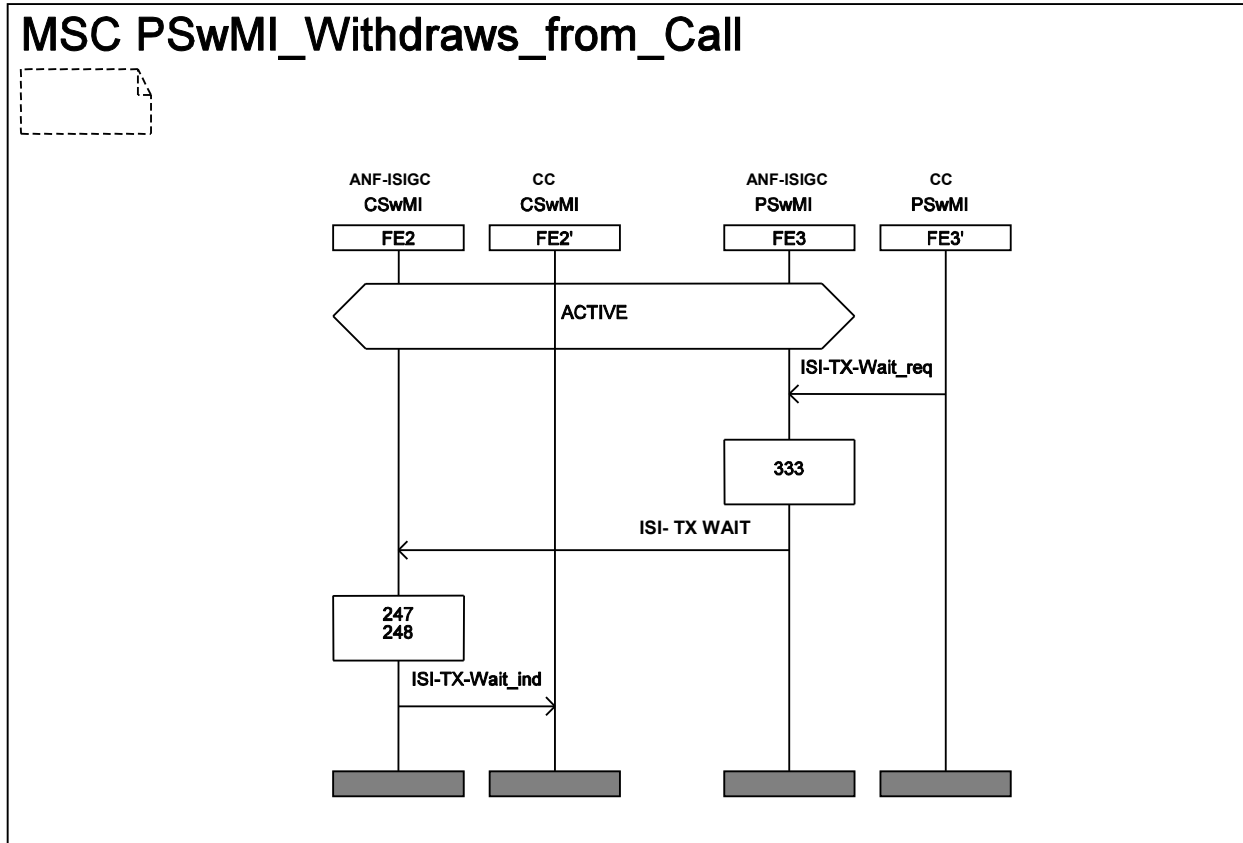

Figure 5.31: Information flow sequence - Request by participating SwMI to withdraw from the active call

When a withdrawn SwMI wishes to continue with an active call an ISI-TX CONTINUE PDU should be sent to the controlling SwMI. If a user located in the withdrawn SwMI was transmitting at the time of withdrawal, permission to transmit shall not automatically be given to this user upon continuation in the active call. Users located in the withdrawn participating SwMI may request permission to transmit. However, if a queuing mechanism is not implemented in the controlling SwMI for transmission control, all transmission request sent from a withdrawn SwMI shall be rejected.

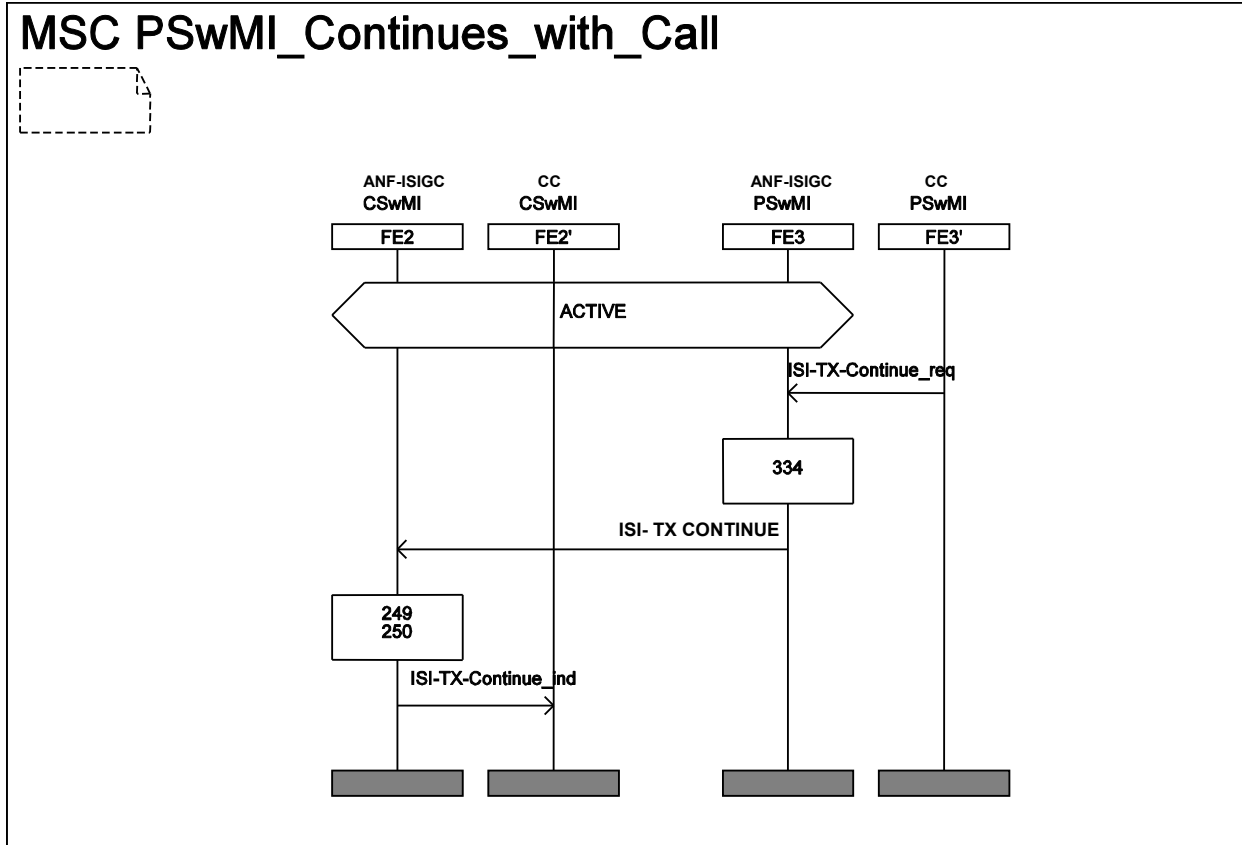

Figure 5.32: Information flow sequence - Request by participating SwMI to continue with the active call

5.2.1.11 Call Maintenance procedures - Information flow to participating SwMI(s)

The controlling and participating SwMI(s) may at any time during the maintenance phase of the group call send extra information to one another. The information shall be contained within the information flow ISI-INFO.

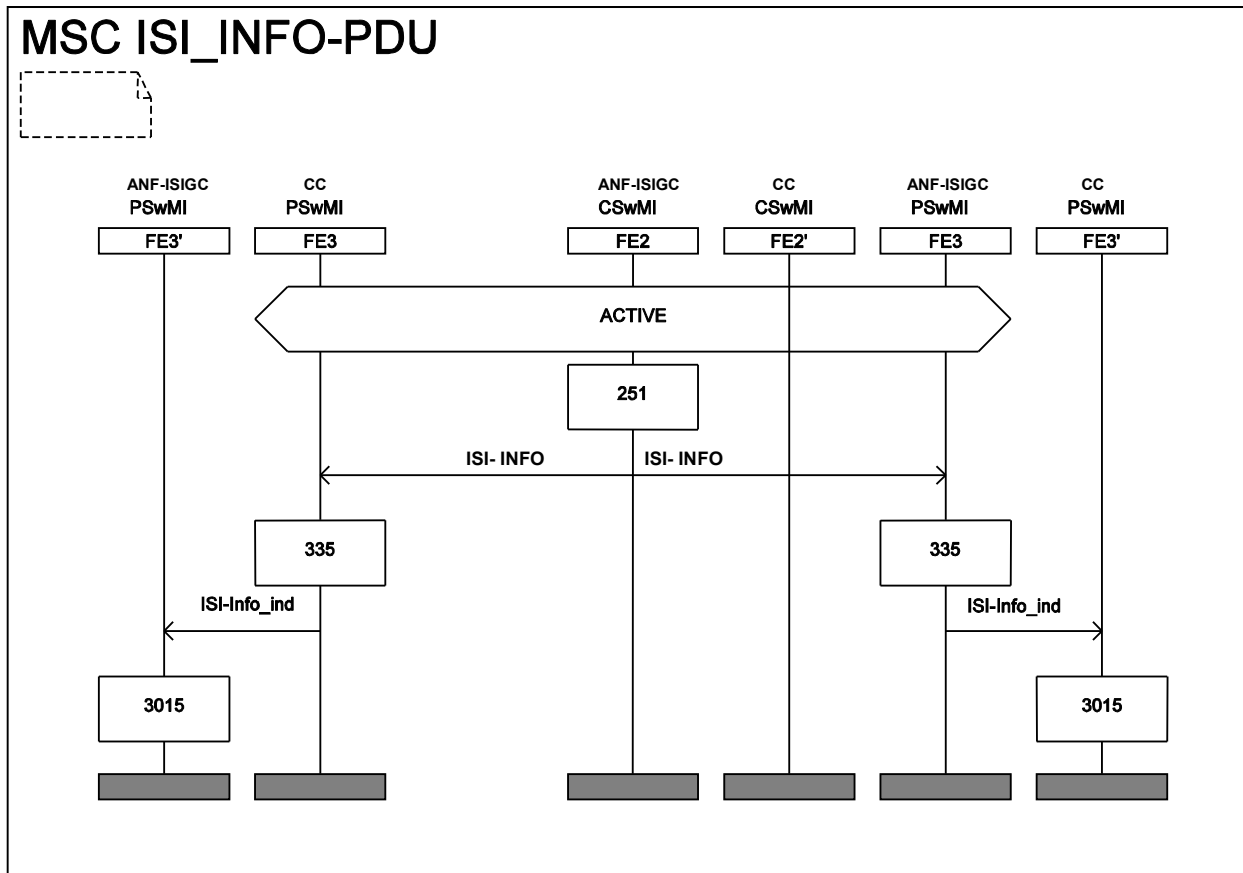

Figure 5.33: Information flow sequence - Information flow sent by the controlling SwMI

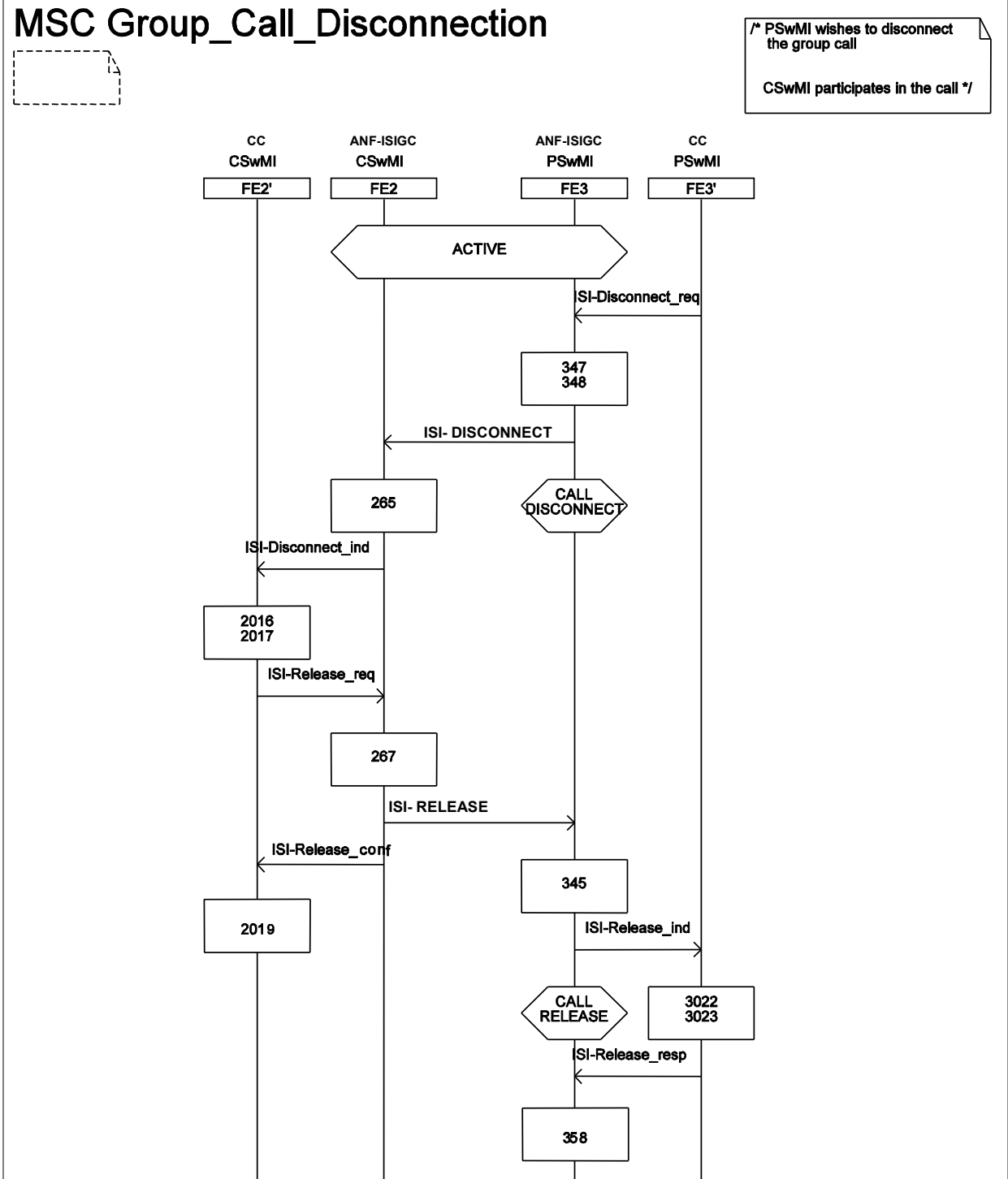

Figure 5.35: Information flow sequence - Partial Group call disconnection

5.2.2 Definitions of Information Flows

5.2.2.1 General about Information Flows

Table 5.1 to table 5.17 list the service elements in the information flows shown in clause 5.2.1. The columns headed "Request" indicates which of these service elements are Mandatory (M) and which are Optional (O) in a request/indication information flow. The columns headed "Confirm" indicates which of these service elements are Mandatory (M) and which are Optional (O) in a response/confirmation information flow.

5.2.2.2 ISI_CONNECT

ISI_CONNECT is an unconfirmed information flow:

- across relationship rd from FE2' to FE2;
- across relationship rf from FE2 to FE3;
- across relationship rg from FE3 to FE3';
- across relationship rc from FE2 to FE1; and
- across relationship ra from FE1 to FE1'.

ISI_CONNECT information flow shall be sent to the originating SwMI and participating SwMI(s) to inform them to through connect.

Table 5.1 lists the service elements within the ISI_CONNECT information flow.

Table 5.1: Content of ISI_CONNECT

Service element	Req/Ind
Set-up type (full, partial)	M
Basic service information	M
Security level at air interface	M
Call priority (emergency, priority 1-14)	M
Call ownership	M
Calling party information present	M
Calling user identity	C (see note)
Transmission grant	M
Transmission request permission	M
Call diverted to a dispatcher	M
Notification indicator	O
Proprietary	O
NOTE: Conditional on the calling party information present.	

5.2.2.3 ISI_DISCONNECT

ISI_DISCONNECT is an unconfirmed information flow:

- across relationship rg from FE3' to FE3;
- across relationship rf from FE3 to FE2;
- across relationship ra from FE1' to FE1;
- across relationship rc from FE1 to FE2; and
- across relationship rd from FE2 to FE2'.

ISI_DISCONNECT information flow shall be used to clear the call at the originating SwMI or a participating SwMI. The ISI_DISCONNECT request/indication information flow shall only be sent when a SwMI wishes to be released from a group call or when the SwMI forwards a call release request made by the call owning user, when this user is located in the SwMI.

Table 5.2 lists the service elements within the ISI_DISCONNECT information flow.

Table 5.2: Content of ISI_DISCONNECT

Service element	Req/Ind
Call owner request	M
Disconnect cause	M
Proprietary	O

5.2.2.4 ISI_INFO

ISI_INFO is an unconfirmed information flow:

- across relationship rd from FE2' to FE2 or FE2 to FE2';
- across relationship rc from FE2 to FE1;
- across relationship ra from FE1 to FE1';
- across relationship rf from FE2 to FE3 or FE3 to FE2; and
- across relationship rg from FE3 to FE3' or FE3' to FE3.

ISI_INFO information flow shall be sent as a general information message from the controlling SwMI to participating SwMI(s) and/or originating SwMI or from a participating SwMI to the controlling SwMI.

Table 5.3 lists the service elements within the ISI_INFO information flow.

Table 5.3: Content of ISI_INFO

Service element	Req/Ind
Reset call time-out timer (T310)	O
Call time-out	O
Call time-out, set-up phase	O
Basic service information:	
Circuit mode service	O
Communication type	O
Data call capacity	C (see note 1)
Data service	C (see note 1)
Encryption flag	O
Speech service	C (see note 1)
Call ownership	O
Call status	O
Poll result identifier	O (see note 2)
Poll response percentage	C (see note 3)
Poll response number	C (see note 3)
DTMF	O
Group information	O
Critical called party identity	C (see note 4)
Notification indicator	O (see note 5)
Proprietary	O
NOTE 1: Depending on the value of circuit mode service.	
NOTE 2: Shall be valid for acknowledge group calls only. For other types of calls it shall be set to 0.	
NOTE 3: Depending on the value of poll result identifier.	
NOTE 4: Conditional on the information element "Group information".	
NOTE 5: Element used by the SwMI for SS's to inform members of the group call of various events.	

5.2.2.5 ISI_INTERACT

ISI_INTERACT is an unconfirmed information flow:

- from one FE2 to another FE2.

ISI_INTERACT information flow shall be sent from one entity to another when a call set-up request is to be merged with an active group call.

Table 5.4 lists the service elements within the ISI_INTERACT information flow.

Table 5.4: Content of ISI_INTERACT

Service element	Req/Ind
Controlling call identifier	M
Originating SwMI MNI	M
Notification indicator	M
Proprietary	M

5.2.2.6 ISI_ORIGINATING SETUP

ISI_ORIGINATING SETUP is an unconfirmed information flow:

- across relationship rc from FE1 to FE2; and
- across relationship rd from FE2 to FE2'.

ISI_ORIGINATING SETUP request/indication information flow shall be sent when a group call set-up request has been made in a SwMI other than the group home SwMI or linking controlling SwMI.

Table 5.5 lists the service elements within the ISI_ORIGINATING SETUP information flow.

Table 5.5: Content of ISI_ORIGINATING SETUP

Service element	Req/Ind
Originating SwMI MNI	M
Calling group identity	O
Selected area number	M
Basic service information:	
Circuit mode service	M
Communication type	M
Data call capacity	C (see note 1)
Data service	C (see note 1)
Encryption flag	M
Speech service	C (see note 1)
Security level at calling user air Interface	M
Speech service requested	C (see note 2)
Call priority (emergency, priority 1 to 14)	M
SS-CLIR invoked for calling party	M
Called party identity	M
Calling party identity	M
Request to transmit/send data	M
Group attachment indicator	M (see note 3)
Speech services supported	O (see note 4)
Proprietary	O
NOTE 1: Depending on the value of circuit mode service.	
NOTE 2: May be sent if the service requested is a speech service.	
NOTE 3: This information element shall indicate whether the calling user is attached to the called group.	
NOTE 4: This element enables future additions to the TETRA air interface CODEC. This information element is not supported in the first edition of the present document.	

5.2.2.7 ISI_POLL

ISI_POLL is a confirmed information flow:

- across relationship rd between FE2' and FE2;
- across relationship rf between FE2 and FE3; and
- across relationship rg between FE3 and FE3'.

ISI_POLL information flow shall be sent when the controlling SwMI wishes to poll members of the group. ISI_POLL response/confirm information flow shall be used as a poll response sent from participating SwMI(s). The poll response shall indicate the actual status of group members located in the participating SwMI(s). Used for acknowledge group calls only.

Table 5.6 lists the service elements within the ISI_POLL information flow.

Table 5.6: Content of ISI_POLL

Service element	Req/Ind	Resp/Conf
Poll request type	M	M
Poll response number	-	C (see note)
Poll response percentage	-	C (see note)
Poll response addresses	-	C (see note)
Proprietary	O	O
NOTE: Depending on the value of the poll request type.		

5.2.2.8 ISI_REJECT

ISI_REJECT is an unconfirmed information flow:

- across relationship rd from FE2' to FE2 or FE2 to FE2';
- across relationship rc from FE2 to FE1 or FE1 to FE2;
- across relationship ra from FE1 to FE1' or FE1' to FE1;
- across relationship rf from FE3 to FE2; and
- across relationship rg from FE3' to FE3.

ISI_REJECT request/indication information flow shall be sent when a forward request cannot be served by the group home SwMI or the linking controlling SwMI or when a set-up request cannot be served by an invoked SwMI (this can either be the originating SwMI or a participating SwMI).

Table 5.7 lists the service elements within the ISI_REJECT information flow.

Table 5.7: Content of ISI_REJECT

Service element	Req/Ind
Reject cause	M
Notification indicator	O (see note)
Proprietary	O
NOTE: Element used by the SwMI for SS's to inform members of the group call of various events.	

5.2.2.9 ISI_RELEASE

ISI_RELEASE is a confirmed information flow:

- across relationship rd between FE2' and FE2;
- across relationship rc between FE2 and FE1;
- across relationship ra between FE1 and FE1';
- across relationship rf between FE2 and FE3; and
- across relationship rg between FE3 and FE3'.

ISI_RELEASE request/indication information flow shall be sent to clear the call at the originating SwMI or participating SwMI(s). The ISI_RELEASE request/indication information flow shall only be sent to a served SwMI after that SwMI has accepted a set-up request. ISI_RELEASE response/confirm information flow shall be sent as a response from the served SwMI CC application to the served SwMI ANF-ISIGC entity that the call has been cleared.

Table 5.8 lists the service elements within the ISI_RELEASE information flow.

Table 5.8: Content of ISI_RELEASE

Service element	Req/Ind	Resp/Conf
Disconnect type (full, partial, delay)	M	M
Disconnect cause	M	M
Notification indicator	O	-
Proprietary	O	O

5.2.2.10 ISI_REROUTE

ISI_REROUTE is an unconfirmed information flow:

- across relationship rd from FE2' to FE2;
- across relationship rc from FE2 to FE1.

ISI_REROUTE information flow shall be sent by the group home SwMI when the group home SwMI is not the linking controlling SwMI. The originating SwMI shall re-route the call to the indicated SwMI.

Table 5.9 lists the service elements within the ISI_REROUTE information flow.

Table 5.9: Content of ISI_REROUTE

Service element	Req/Ind
Forwarded-to group address SSI	M
Controlling SwMI MNI	M
Notification indicator	O
Proprietary	O

5.2.2.11 ISI_RESOURCE

ISI_RESOURCE is a confirmed information flow:

- across relationship rd between FE2' and FE2;
- across relationship rf between FE2 and FE3; and
- across relationship rg between FE3 and FE3'.

ISI_RESOURCE request/indication information flow shall be sent to all participating SwMIs with temporary allocation of resources to evaluate if resources are available for transmission when a user has request to transmit. The ISI_RESOURCE response/confirm information flow is sent by participating SwMI(s) after evaluating if resources are available for transmission.

Table 5.10 lists the service elements within the ISI_RESOURCE information flow.

Table 5.10: Content of ISI_RESOURCE

Service element	Req/Ind	Resp/Conf
Resource indicator	-	M
Notification indicator	O	-
Proprietary	O	O

5.2.2.12 ISI_SETUP

ISI_SETUP is a confirmed information flow:

- across relationship rd between FE2' and FE2;
- across relationship rc between FE2 and FE1;
- across relationship rf between FE2 and FE3;
- across relationship ra between FE1 and FE1'; and
- across relationship rg between FE3 and FE3'.

The ISI_SETUP request/indication information flow enables the TETRA call to be set-up by the controlling SwMI to all SwMIs were members of the group call exist. The ISI_SETUP response/confirm information flow is sent by invoked SwMI(s) after evaluating if resources are available for set-up of a group call.

Table 5.11 lists the service elements within the ISI_SETUP information flows.

Table 5.11: Content of ISI_SETUP

Service element	Req/Ind	Resp/Conf
Controlling SwMI MNI	M	-
Originating SwMI MNI	M	-
Participating SwMI MNI	M	-
Linking group identity	O	-
Basic service information:		
Circuit mode service	M	M
Communication type	M	M
Data call capacity	C (see note 1)	C (see note 1)
Data service	C (see note 1)	C (see note 1)
Encryption flag	M	M
Speech service	C (see note 1)	C (see note 1)
Speech services chosen	C (see note 2)	-
Speech service requested	-	C (see note 2)
Speech Service Supported	-	O
Security level at air interface	M	M
Call priority	M	-
Call ownership	M	-
Call time-out	M	-
SS-CLIR invoked for calling party	M	C (see note 7)
SS-COLR invoked for the connected group	M	-
Called/Connected party identity	M	-
Critical called party identity	O	-
Calling party identity	M (see note 3)	-
Temporary group member indication	M (see note 4)	-
Temporary group basic migration profile	C (see note 5)	-
SS-migration profile	C (see note 6)	
Resource allocation	-	M
Call Resource Time	-	M
Group Call SwMI type	-	M
Request to transmit/send data	-	C (see note 7)
Transmission request permission	M	-
Dispatcher acceptance	M	-
Setup response time-out	M	-
Call amalgamation	M	-
Critical user list	O	-
Notification indicator	O	-
Proprietary	O	O
NOTE 1: Depending on the value of circuit mode service. NOTE 2: May be sent if the service requested is a speech service. NOTE 3: The calling party identity is used by the originating SwMI to identify the calling user. NOTE 4: Indication to the originating SwMI that the calling user is temporarily a member of the called group. NOTE 5: Depending on the value of temporary group member indication. The profile shall reflect the actual call being connected. NOTE 6: Depending on the value of temporary group member indication. The contents of SS-ISI PROFILE shall be as defined, if applicable, for the supplementary service in each supplementary service sub-part of ETSI EN/ETS 300 392-12 [7]. NOTE 7: Conditional on the value of the information sub-element "Group call SwMI type" being equal to "From Originating SwMI".		

5.2.2.13 ISI_TX-CEASED

ISI_TX-CEASED is an unconfirmed information flow:

- across relationship rg from FE3' to FE3 or FE3 to FE3'; and
- across relationship rf from FE3 to FE2 or FE2 to FE3.

ISI_TX-CEASED request/indication information flow shall be sent from a participating SwMI when a user wishes to cease transmission. ISI_TX-CEASED request/indication information flow shall be sent from the controlling SwMI to all participating SwMI(s) to indicate that the transmitting user has ceased transmission.

Table 5.12 lists the service elements within the ISI_TX-CEASED information flow.

Table 5.12: Content of ISI_TX-CEASED

Service element	Req/Ind
Requesting user identifier	M
Transmission ceased	M
Transmission request permission	C (see note)
Notification indicator	O
Proprietary	O
NOTE: Shall only be valid when this PDU has been sent from the controlling SwMI.	

5.2.2.14 ISI_TX-CONTINUE

ISI_TX-CONTINUE is an unconfirmed information flow:

- across relationship rg from FE3' to FE3;
- across relationship rf from FE3 to FE2; and
- across relationship rd from FE2 to FE2'.

ISI_TX-CONTINUE request/indication information flow shall be sent from a participating SwMI when it wishes to continue with a withdrawn group call.

Table 5.13 lists the service elements within the ISI_TX-CONTINUE information flow.

Table 5.13: Content of ISI_TX-CONTINUE

Service element	Req/Ind
Participating SwMI MNI	M
Proprietary	O

5.2.2.15 ISI_TX-DEMAND

ISI_TX-DEMAND is a confirmed information flow:

- across relationship rg between FE3' and FE3; and
- across relationship rf between FE3 and FE2.

ISI_TX-DEMAND request/indication information flow shall be sent from a participating SwMI, when a member of the active group call wishes to transmit.

Table 5.14 lists the service elements within the ISI_TX-DEMAND information flow.

Table 5.14: Content of ISI_TX-DEMAND

Service element	Req/Ind
Requesting party identifier	M
SS-CLIR invoked for requesting party	M
TX demand priority	M
Encryption control	M
Transmission grant	-
Notification indicator	O
Proprietary	O

5.2.2.16 ISI_TX-GRANTED

ISI_TX-GRANTED is an unconfirmed information flow:

- across relationship rf from FE2 to FE3; and
- across relationship rg from FE3 to FE3'.

ISI_TX-GRANTED request/indication information flow shall be sent to the participating SwMI(s) to indicate if the permission to transmit has been granted, granted to another, queued or rejected to a member of the active group call.

Table 5.15 lists the service elements within the ISI_TX-GRANTED information flow.

Table 5.15: Content of ISI_TX-GRANTED

Service element	Req/Ind
SS-CLIR invoked for transmitting party	M (see note)
Transmission request permission	M
Transmission grant	M
Encryption control	M
Transmitting party identifier	O
Notification indicator	O
Proprietary	O
NOTE: Talking party identification shall be presented.	

5.2.2.17 ISI_TX-INTERRUPT

ISI_TX-INTERRUPT is an unconfirmed information flow:

- across relationship rf from FE2 to FE3; and
- across relationship rg from FE3 to FE3'.

ISI_TX-INTERRUPT request/indication information flow shall be sent to the participating SwMI(s) to indicate that transmission has been interrupted and granted to another user.

Table 5.16 lists the service elements within the ISI_TX-INTERRUPT information flow.

Table 5.16: Content of ISI_TX-INTERRUPT

Service element	Req/Ind
SS-CLIR invoked for transmitting party	M (see note)
Transmission request permission	M
Transmission grant	M
Encryption control	M
Transmitting party identifier	M
Notification indicator	O
Proprietary	O
NOTE: Talking party identification shall be presented.	

5.2.2.18 ISI_TX-WAIT

ISI_TX-WAIT is an unconfirmed information flow:

- across relationship rg from FE3' to FE3;
- across relationship rf from FE3 to FE2; and
- across relationship rd from FE2 to FE2'.

ISI_TX-WAIT request/indication information flow shall be sent from a participating SwMI when it wishes to withdraw from an active group call.

Table 5.17 lists the service elements within the ISI_TX-WAIT information flow.

Table 5.17: Content of ISI_TX-WAIT

Service element	Req/Ind
Participating SwMI MNI	M
Proprietary	O

5.3 Functional Entity Actions (FEAs)

5.3.1 Functional Entity Actions of FE1

The following FE actions shall occur at the points indicated in figures in clause 5.2.1:

- 101 Detect an outgoing ISI group call request sent from an originating SwMI CC application (FE1').
- 102 Void.
- 103 Void.
- 104 Obtain the routing information to the controlling SwMI, FE2. Send ISI_ORIGINATING SETUP over the ISI to FE2 for further processing.
- 105 Void.
- 106 Receive an ISI_SETUP INITIATE from FE2 requesting that a group call is to be set-up in this SwMI to all MSs attached to the called GTSI.
- 107 Send ISI_Setup_ind the request to FE1' for evaluation.
- 108 Receive an ISI_SETUP_resp from FE1'.
- 109 Send an ISI-SETUP ACKNOWLEDGE to FE2 confirming that the OSwMI is able to participate in the call and ready for the through connection of the call. Wait for a response from FE2 on the through connection request.
- 110 Receive an ISI-CONNECT from FE2 indicating that the group call is about to be through connected.
- 111 Send ISI-Connect_ind to inform FE1' to connect the calling user using the reserved resources. Initiate a FE3.
- 112 The group call set-up is to be delayed.
- 113 Inform FE1' of the delayed call with an ISI_RELEASE ind.
- 114 The reserved resources have been released. Call set-up has now been delayed.
- 115 Void.
- 116 FE1 shall now be ceased to exist, replaced by a participating SwMI, FE3.
- 117 The group call request has been rejected by the group home SwMI.
- 118 Inform FE1' of the rejected group call request by sending ISI-Reject_ind.
- 119 The group call set-up has been rejected. The call will be released.
- 120 Inform FE1' of the rejected call set-up with an ISI_RELEASE ind.
- 121 The reserved resources have been released.
- 122 Void.

- 123 Receive an ISI-SETUP INITIATE from FE2 indicating that the group call request is merged to an active call.
- 124 An ISI-INFO has been received from the controlling SwMI. Forward this information to FE1'.

5.3.2 Functional Entity Actions of FE1'

The following FE actions shall occur at the points indicated in figures in clause 5.2.1:

- 1001 Detect an outgoing group call request sent over the air interface. Analyse the calling MS's profiles and the called group identity (GTSI/linked GSSI). Evaluate if the MS is allowed to initiate an ISI group call and whether or not the MS is allowed to use the requested tele or bearer service across the ISI.
- 1002 Send ISI_Originating Setup_req to the originating FE1.
- 1003 Void.
- 1004 Evaluate if the necessary resources are available for a group call. If a group call can be performed in the originating SwMI(s), the necessary resources should be reserved.
- 1005 Send an ISI_Setup_resp to FE1 confirming that the SwMI is able to participate in the call and ready for the through connection of the call. Wait for the through connection request.
- 1006 Connect calling user.
- 1007 The group call set-up is delayed. Release reserved resources. Respond to FE1 with ISI-Release_resp (the ISI resources shall be maintained).
- 1008 The call set-up request has been rejected by the group home SwMI.
- 1009 The group call set-up is rejected. Send ISI-Release_resp as a response to FE1 (the call may continue locally).
- 1010 Evaluate the received call data (basic service information).
- 1011 An ISI-INFO PDU has been sent from the controlling SwMI. Inform the calling user.

5.3.3 Functional Entity Actions of FE2

The following FE actions shall occur at the points indicated in figures in clause 5.2.1:

- 201 Receive a call request as an ISI-ORIGINATING SETUP from FE1.
- 202 Send ISI-Originating Setup_ind to FE2' to be evaluated.
- 203 The called group has been evaluated by the group home or linking controlling SwMI.
- 204 Void.
- 205 Void.
- 206 The called group is linked and the group home SwMI is not the linking controlling SwMI. Inform the originating SwMI, FE1, to re-route the ISI-ORIGINATING SETUP to the linking controlling SwMI. An ISI-REROUTE is sent to the originating SwMI.
- 207 Inform the originating SwMI by ISI-INFO of the call time out for the set-up phase and of call status.
- 208 Void.
- 209 Void.
- 210 Void.
- 211 Send an ISI-SETUP INITIATE over the ISI to the SwMI(s) indicated by the routing information. The ISI-SETUP INITIATE shall also be sent to the originating SwMI. Wait for a response from important or all invoked participating SwMIs (FE3s) and the originating SwMI.

- 212 Send an ISI-REJECT over the ISI to the originating FE1. Release the transport connection oriented, call related connection between the group home SwMI (FE2) and the originating SwMI (FE1).
- 213 Receive all ISI-SETUP ACKNOWLEDGE, ISI-DELAY and ISI-REJECT responses from FE3s and FE1. Collect all responses and send ISI-Setup_conf to FE2'.
- 214 Receive an ISI_Connect_req from FE2'. Connect the group call to the FE3s and FE1 indicated in the ISI_CONNECT req.
- 215 Send an ISI-CONNECT to the indicated SwMI(s).
- 216 Receive an ISI_Release_req from a FE2'. Inform the SwMIs (FE3s and FE1) indicated in the ISI_Release_req that SwMI internal resources can be released. If the call set-up is to be delayed the ISI resources shall be maintained.
- 217 Send the ISI-RELEASE to the indicated SwMIs.
- 218 Void.
- 219 Receive an ISI-SETUP ACKNOWLEDGE from the delaying FE3 confirming that the participating SwMI is able to set-up the call and requesting that the call is through connected.
- 220 Send ISI_Setup_conf to FE2'.
- 221 Send an ISI-SETUP INITIATE to FE1 and the non-delayed FE3s informing them that the group call set-up shall continue.
- 222 Send ISI_Setup_conf to FE2' to inform that all SwMIs have confirmed that the participating SwMI is able to set-up the call and requesting that the call is through connected.
- 223 Receive an ISI-Poll_req. from FE2'.
- 224 Send an ISI-POLL USER to the FE3s informing that group members are to be polled.
- 225 For each polling response from FE3s send ISI-Poll_conf to FE2'.
- 226 Void.
- 227 Void.
- 228 Void.
- 229 An ISI-TX_DEMAND has been received from a participating SwMI. Evaluate if the transmission request conflicts with any currently granted transmission. Only one participating SwMI is awarded the right to transmit while other transmission requests shall be queued or rejected.
- 230 Send an ISI-RESOURCE over the ISI to all participating FE3s with temporary resources.
- 231 Void.
- 232 Check if any new SwMIs (SwMIs not participating in the active group call) are to be included in the call.
- 233 Send an ISI-SETUP INITIATE over the ISI to the newly registered FE3s. Wait for ISI-SETUP ACKNOWLEDGE from important or all FE3s.
- 234 Receive all ISI-SETUP ACKNOWLEDGE, ISI-REJECT (in case of Late Entry has been invoked) and ISI-RESOURCE RESPONSE from FE3s. Collect all responses.
- 235 Evaluate if transmission can be granted to the requesting user.
- 236 Permission to transmit is to be granted. Inform FE3 of the granted user of the permission to transmit with an ISI-TX GRANTED PDU. The parameter value, transmission grant, is set to 'transmission granted'. The other SwMIs involved in the call are also informed of the granted transmission by an ISI-TX_GRANTED PDU. The parameter value, transmission grant, is set to 'transmission granted to another user'. The ISI-TX_GRANTED PDU is group addressed, but it shall contain an individual address as to who has received transmission permission.

- 237 The transmission request has been queued. The requested user is informed of the queued request by setting the 'transmission request queued' parameter value in the ISI-TX GRANTED that is sent to FE3.
- 238 The transmission request has been rejected. The requested user is informed of the rejected request by setting the "transmission not granted" parameter value in the ISI-TX GRANTED sent to FE3.
- 239 A pre-emptive priority request has been received. Check if a user currently has transmission rights.
- 240 The transmitting user is to be interrupted.
- 241 The SwMIs involved in the call are informed of the interrupted transmission by sending an ISI-TX INTERRUPT to FE3s . The parameter value, transmission grant, is set to 'transmission granted to another user'. The ISI-TX INTERRUPT PDU is group addressed, but it shall contain an individual address as to who has received transmission permission.
- 242 An ISI-TX_CEASED has been received from a participating SwMI. Check if the user is the one which that currently has transmission rights.
- 243 Transmission has ceased. Check if requests to transmit have been queued in the controlling SwMI.
- 244 No request to transmit has been queued in the controlling SwMI. Inform all users participating in the group call that transmission has ended by sending ISI-TX CEASED to FE3s.
- 245 Requests to transmit are queued in the controlling SwMI. Grant permission to transmit to the first user in queue with the highest priority transmission request.
- 246 A user wishes to withdraw a request to transmit in the controlling SwMI. Remove request. No response is sent back to the user.
- 247 An ISI-TX WAIT has been received from a participating SwMI. Evaluate if the group call shall continue or be released.
- 248 The active group call is to continue without the withdrawn participating SwMI. No response is sent back to the withdrawn SwMI.
- 249 A withdrawn SwMI wishes to continue with the active group call. If a user located in the withdrawn SwMI was transmitting at the time of withdrawal, permission to transmit shall not automatically be given to this user upon continuation in the active call. Users located in the withdrawn participating SwMI may request permission to transmit during withdrawal. However, if a queuing mechanism is not implemented in the controlling SwMI for transmission control, all transmission request sent from a withdrawn SwMI shall be rejected. Transmission permission shall not be granted to a user in a withdrawn SwMI.
- 250 The withdrawn participating SwMI has rejoined the active group call. No response is sent back to the SwMI.
- 251 The controlling SwMI wishes to send information out to the participating SwMI(s).
- 252 Void.
- 253 Void.
- 253a Void.
- 254 Void.
- 254a Void.
- 255a Void.
- 256 Void.
- 257 Void.
- 258 Void.
- 259 Void.
- 260 Void.

- 261 ISI_Release_req is received from FE2' because the controlling SwMI wishes to terminate the group call, e.g. resources are required for another call, failed service modification or the call time out timer has timed out.
- 262 The FE2 shall inform all FE3(s) of the call disconnection in an ISI-RELEASE. Reason for disconnection shall be sent along in the PDU.
- 263 Void.
- 264 Send ISI-Realease_conf to FE2'. Confirmation of the release of the transport connection oriented call related call, between the controlling SwMI (FE2) and all participating SwMI(s) (FE3).
- 265 A participating SwMI wishes to be released from the group call. FE2 sends ISI_Disconnect_ind to FE2'.
- 266 The call owner has initiated disconnection of the group call. FE2 sends ISI_Disconnect_ind to FE2'.
- 267 The controlling SwMI shall inform the release requesting SwMI of the call disconnection in an ISI-RELEASE Reason for disconnection shall be sent along in the PDU.
- 268 ISI-Interact_req is received from FE2' because a SwMI which is not participating in the group call wishes to join the active group call. The two ANF-ISIGC entities is to interact as one ANF-ISIGC entity.
- 269 Void.
- 270 Inform the originating SwMI that the group call request is accepted. The call amalgamation may indicated in the ISI-SETUP INITIATE. The calling party information element shall indicate the current transmitting party, if any.
- 272 Void.
- 273 Void.
- 274 Permission to transmit has been delayed. Inform the SwMIs with temporary resources of the transmission delay with an ISI-TX_CEASED PDU. The parameter value, transmission ceased, is set to "Delay transmission request". The ISI-TX CEASED PDU is group addressed, but it shall contain an individual address as to who requested transmission permission.
- 275 Receive ISI-RESOURCE RESPONSE from FE3.

5.3.4 Functional entity actions of FE2'

The following FE actions shall occur at the points indicated in figures in clause 5.2.1:

- 2001 Receive an ISI_Originating Setup_ind from FE2 requesting that a group call be made to the called GTSI. Evaluate if the group call can be performed.
- 2002 Send ISI-Setup_req to request FE2 to set-up the group call to all involved SwMIs.
- 2003 The call set-up request shall be re-routed to the linking controlling SwMI. Send ISI_reroute_req to FE2. This FE2' ceases to exist.
- 2004 Receive an ISI_Setup_conf from FE2 where all received set-up responses are collected. Evaluate the received responses. FE2' may at any time choose to proceed with the set-up towards the active phase although not all participating SwMIs have responded or participating SwMIs wish to delay the call.
- 2005 Send an ISI_Connect_req to FE2 requesting that the group call be through connected.
- 2006 The group call is to be delayed. Send ISI-Release_req to request FE2 to delay the call establishment the indicated SwMIs.
- 2007 No further actions are taken for this call. Wait for a response from the delaying SwMI(s).
- 2008 A partial group call is to be set-up. Send an ISI_Connect_req to FE2 requesting that the group call be through connected.
- 2009 Request FE2 to interact with an active ANF-ISIGC. An individual in a SwMI which is not a included in the group call is requesting to join the active group call.

- 2010 Resolve status on the existing call.
- 2011 Merge the calling SwMI into the call.
- 2012 A group call cannot be made to the called group. Request FE2 to reject the group call request.
- 2013 A group call cannot be made to the called group. Request FE2 to release the group call request.
- 2014 Void.
- 2015 Void.
- 2016 A participating SwMI wishes to be released from the group call. Evaluate if the group call should continue without the participating SwMI or if the call should be released.
- 2017 The call is to continue without the release requesting SwMI. Inform the SwMI that it shall release from the call.
- 2018 The call owner has initiated disconnection of the group call. Inform FE2 to send an ISI-RELEASE to all indicated participating SwMI(s).
- 2019 Release is complete.
- 2020 Void.

5.3.5 Functional Entity Action of FE3

The following FE actions shall occur at the points indicated in figures in clause 5.2.2:

- 301 Receive an ISI-SETUP INITIATE from FE2 requesting that a group call is to be set-up in this SwMI to all MSs attached to the called GTSI.
- 302 Forward the request to FE3' for evaluation.
- 303 Receive an ISI_Setup_resp. from FE3'.
- 304 Send an ISI-SETUP ACKNOWLEDGE to FE2 confirming that the SwMI is able to participate in the call and ready for the through connection of the call. Wait for a response from FE2 on the through connection request.
- 305 Receive an ISI_Reject_req. from FE3'.
- 306 Forward the rejected call set-up to FE2.
- 307 Receive an ISI-CONNECT from FE2 indicating that the group call is about to be through connected.
- 308 Inform FE3' to connect members of the group call using reserved resources.
- 309 FE3 should co-ordinate the call identity with FE1 and send ISI-Connect_ind to FE3'.
- 310 Void.
- 311 Void.
- 312 Void.
- 313 Void.
- 314 Receive an ISI-POLL USER from FE2 indicating that group members shall be polled.
- 315 Request the participating SwMI CC application to poll group members in the active call.
- 316 Result of polling request received.
- 317 Inform FE2 of the polling result in an ISI-POLL RESPONSE.
- 318 Void.

- 319 Void.
- 320 Void.
- 321 Void.
- 322 Void.
- 323 A user wishes to transmit. The ISI-TX DEMAND is forwarded to the controlling SwMI for evaluation.
- 324 Receive an ISI-RESOURCE from FE2 requesting the SwMI to evaluate if resources are available for transmission.
- 325 Forward the request to FE3' for evaluation.
- 326 Receive an ISI_Resource_resp. form FE3'.
- 327 Send an ISI-RESOURCE RESPONSE to FE2 confirming that the SwMI is able to participate. Wait for a transmission grant from FE2.
- 328 An ISI-TX GRANTED or an ISI-TX CEASED has been received from the controlling SwMI. Inform FE3' of the transmission request result.
- 329 Void.
- 330 An ISI-TX INTERRUPT has been received from the controlling SwMI. Inform the users participating in the group call that transmission has been interrupted and granted to another user.
- 331 A user has ended transmission or wishes to withdraw a request for transmission. The FE2 is informed with an ISI-TX CEASED.
- 332 Transmission has ceased. No user has currently received permission to transmit.
- 333 A participating SwMI wishes to withdraw from the active call. The controlling SwMI is informed of the withdrawal.
- 334 A participating SwMI wishes to continue with an active group call. The controlling SwMI is informed with an ISI-TX CONTINUE.
- 335 An ISI-INFO has been received from the controlling SwMI. Send ISI_Info_req to FE3'.
- 336 Void.
- 337 Void.
- 338 Void.
- 339 Void.
- 340 Void.
- 341 Void.
- 342 Void.
- 343 Void.
- 344 Void.
- 345 An ISI-RELEASE has been received. Inform the participating SwMI call control application that the call is to be disconnected immediately by sending ISI-Release_ind to FE3'.
- 346 Void.
- 347 ISI-Disconnect_req is received from FE3'.The participating SwMI wishes to be released from the group call, e.g. resources are required for another call or the call time out timer has timed out.

- 348 FE3 shall inform FE2 of the call disconnection in an ISI-DISCONNECT Reason for disconnection shall be sent along in the PDU.
- 349 ISI-Disconnect_req is received from FE3' indicating that the call owner has initiated a disconnect of the entire group call.
- 350 Void.
- 351 Void.
- 352 Void.
- 353 Void.
- 354 Void.
- 355 Void.
- 356 Receive an ISI_DELAY req. from FE3'.
- 357 Send ISI-DELAY to FE2. Wait for a response from FE2.
- 358 Release is complete.
- 359 Send an ISI-RESOURCE RESPONSE to FE2 confirming that the SwMI is able to participate, but the resources are currently no available.

5.3.6 Functional entity actions of FE3'

The following FE actions shall occur at the points indicated in figures in clause 5.2.1:

- 3001 Evaluate if the necessary resources are available and that group members exist in the participating SwMI. If a group call can be performed in the participating SwMI, the necessary resources should be reserved.
- 3002 Send an ISI_Setup_resp to FE3 confirming that the SwMI is able to participate in the call and ready for the through connection of the call. Wait for through connection request.
- 3003 Connect group members using reserved resources.
- 3004 Send an ISI_Delay_req to FE3 indicating that the SwMI wishes the call set-up to be delayed.
- 3005 Send an ISI_Reject_req to FE3 indicating that the SwMI cannot support the group call set-up.
- 3006 Void.
- 3007 The delaying SwMI now wishes to continue with call set-up.
- 3008 The participating SwMI CC application (FE3') is requested to poll all indicated users.
- 3009 The result of polling is sent by ISI_Poll_resp to FE3.
- 3010 Void.
- 3011 Transmission is granted to the requesting user. Inform the requesting user (if present in this SwMI) and members of the group call of granted transmission.
- 3012 The transmission request has either been queued or rejected. FE3' may inform the requesting user of transmission request result.
- 3013 The current transmission is interrupted. Inform the transmitting user (if present in this SwMI) and the members of the group call of the interruption. Inform the requesting user (if present in this SwMI) that transmission is granted.
- 3014 Inform group members that transmission has ceased.
- 3015 An ISI-INFO PDU has been sent from the controlling SwMI. Inform members of the group call.

- 3016 Void.
- 3017 Void.
- 3018 Void.
- 3019 Void.
- 3019a Void.
- 3020 Void.
- 3021 Void.
- 3022 The group call is to be disconnected. Release all used and reserved resources. Inform the members of the group call of the disconnection.
- 3023 The members of the group call have been disconnected and all resources are released.
- 3024 Evaluate if the necessary resources are available and that group members exist in the participating SwMI. If transmission can be performed in the participating SwMI(s), the necessary resources should be reserved.
- 3025 Send an ISI_Resource_resp to FE3 confirming that the SwMI is able to participate. Wait for transmission granted.
- 3026 Void.
- 3027 Resources are now available for transmission.
- 3028 Send an ISI_Resource_resp to FE3 indicating that the SwMI is able to participate, but resources are currently not available.

6 ANF-ISIGC stage 3 specification

6.1 ANF-ISIGC description

See clause 4.

6.2 ANF-ISIGC operational requirements

The requirements specific for each type of SwMI are stated below. In addition, each SwMI shall comply with the requirements stated in clause 7.4 of ETSI TS 100 392-3-9 [2], for the support of the ISI protocol.

6.3 ANF-ISIGC coding requirements

6.3.1 TETRA ANF-ISIGC PDUs

6.3.1.1 General Information about PDU Descriptions

TETRA specific messages shall be sent using an Invoke APDU of the ISI operation tetraIsiMessage defined in table 7.1 of ETSI TS 100 392-3-9 [2].

The information contained in the following PDU descriptions shall be encoded using the same rule as defined in clause 14.7 of ETSI EN 300 392-2 [1] (for TETRA air interface PDUs).

The definitions of all possible TETRA PDUs, are given in the following clauses.

6.3.1.2 ISI-ORIGINATING SETUP PDU sent by the originating SwMI - used to forward a call set-up request

The contents and the encoding of the ISI-ORIGINATING SETUP PDU sent by the originating SwMI shall be as defined in table 6.1.

The ISI-ORIGINATING SETUP PDU may be sent at any phase of the call to indicate to the CSwMI that there is a new calling subscriber. A SwMI that sends an ISI-ORIGINATING SETUP PDU before the call is connected is, or becomes, an OSwMI. A SwMI that is already an OSwMI is not required to send further ISI-ORIGINATING SETUP PDUs when other calling parties appear, but may send them if it wishes. Once the call setup has started, but the call has not yet been connected a PSwMI may send in an ISI-ORIGINATING SETUP PDU when a new calling subscriber appears.

Table 6.1: Contents of ISI-ORIGINATING SETUP PDU sent by the originating SwMI

Information element	Length	Type	Owner	C/O/M	Remark
PDU type	6	1	CCAp	M	ISI-ORIGINATING SETUP
Selected area number	8	1	ANF	M	
Originating SwMI MNI	24	1	ANF	M	
Calling group identifier	1	1	ANF	M	
Calling group MNI	24		ANF	C	See note 9
Calling group SSI	24		ANF	C	See note 9
Basic service information	8	1	CCAp	M	
Speech service requested	3		CCAp	C	See note 1
Security level at air interface	2	1	MM	M	
Request to transmit/send data	1	1	CCAp	M	
Call priority	4	1	CCAp	M	
Called party SSI	24	1	CCAp	M	See note 2
Called party extension	24	1	CCAp	M	See note 2
SS-CLIR invoked for calling party	1	1	SS	M	
Group attachment indicator	1	1	CCAp	M	See note 3
Calling party SSI	24	1	CCAp	M	See note 4
Calling party extension	24	1	CCAp	M	See note 4
External subscriber number length	5	1	CCAp	M	See note 5
External subscriber number digits	variable		CCAp	C	See note 6
External subscriber number parameters	9		CCAp	C	See note 7
Speech services supported	5	2	CCAp	O	See note 8
Notification indicator	6	2	SS	O	
Proprietary		3	-	O	
NOTE 1: Conditional on the binary value of the information sub-element 'circuit mode type' in the information element 'basic service information' being equal to 0 (i.e. the call requested is a speech call).					
NOTE 2: This element shall always indicate the actual called group identity.					
NOTE 3: This information element shall indicate whether the calling user is attached to the called group in the originating SwMI.					
NOTE 4: In the case of an external incoming call, the calling party SSI and the calling party extension shall be those of the incoming gateway SwMI.					
NOTE 5: Shall be equal to 00000 ₂ in the case of inter-TETRA calls, and to N, N being the number of digits of the external calling party number in the case of an external incoming call from PSTN/ISDN/PISN if the calling party identification is delivered by that external network.					
NOTE 6: The number of digits included in this information element shall be equal to N, the value of the external subscriber number length (see note 5), i.e. this information element shall be conditional on the value of N.					
NOTE 7: This information element shall be present only when the external subscriber number length value N is not 00000 ₂ .					
NOTE 8: This element enables future additions to the TETRA air interface CODEC.					
NOTE 9: This information element shall be present only when the Calling group identifier information element is set to 'Calling group GTSI present'.					

- The SwMI MNI identifications are necessary:
 - for enforcing security mechanisms agreed between operators; or
 - to identify whether or not a proprietary feature can be used over the ISI.

6.3.1.3 ISI-SETUP INITIATE PDU sent by the controlling SwMI - used for setting up a group call

The contents and the encoding of the ISI-SETUP INITIATE PDU sent by the controlling SwMI shall be as defined in table 6.2.

The ISI-SETUP INITIATE PDU is sent by a CSwMI during call setup to O/PSwMIs that are part of the call. The ISI-SETUP INITIATE PDU is sent as a response to the first ISI-ORIGINATING SETUP PDU received for a call and as the first PDU sent to all of the PSwMIs in the group call. In the first use of ISI-SETUP INITIATE PDU in a call, the ISI-SETUP INITIATE PDU is sent to all SwMIs in the call. Subsequent ISI-ORIGINATING SETUP PDUs on the existing connection for the call are not responded to with ISI-SETUP INITIATE PDU. However, if the ISI-ORIGINATING SETUP PDUs come in to the CSwMI on a new connection an ISI-SETUP INITIATE PDU is sent in response.

Before the call is connected, a CSwMI may send out further ISI-SETUP INITIATE PDUs. It does this after the call setup has been delayed, by the CSwMI, and it then decides to try to set the call up again. In this case ISI-SETUP INITIATE PDU can only be sent to SwMIs to which the CSwMI has previously sent ISI-RELEASE PDU (delay group call setup). SwMIs that are still delaying themselves and have not yet sent in an ISI-SETUP ACKNOWLEDGE PDU shall not be sent an ISI-SETUP-INITIATE PDU.

An ISI-SETUP-INITIATE PDU is sent to any OSwMI, not currently in the call, that sends in an ISI-ORIGINATING SETUP PDU to the existing group, this can occur in any phase of the call.

During the maintenance phase of the call, a CSwMI may use an ISI-SETUP INITIATE PDU to bring in any new PSwMI into the call. This is "late entry" of a PSwMI into the call.

The ISI-SETUP INITIATE PDUs can be sent in a connection release message in the case of a new calling party appearing at an OSwMI or a PSwMI (crossing events). The connection being used by the ISI-ORIGINATING SETUP PDU sent as a result of the new calling party is being closed down and the connection being used by the existing call is used from now on.

Table 6.2: Contents of ISI-SETUP INITIATE PDU sent by the controlling SwMI

Information element	Length	Type	Owner	C/O/M	Remark
PDU type	6	1	CCAp	M	ISI-SETUP INITIATE
Selected area number	8	1	ANF	M	
Controlling SwMI MNI	24	1	ANF	M	
Linking group type identifier	1	1	ANF	M	
Linking group SSI	24		ANF	C	See note 14
Linking group MNI	24		ANF	C	See note 14
Originating SwMI MNI	24	1	ANF	M	
Call time-out	4	1	CCAp	M	
Basic service information	8	1	CCAp	M	
Speech service chosen	3		CCAp	C	See note 1
Security level at air interface	2	1	MM	M	See note 15
Call priority	4	1	CCAp	M	
Call ownership	1	1	CCAp	M	
SS-COLR invoked for connected group	1	1	SS	M	
Connected party SSI	24	1	CCAp	M	
Connected party extension	24	1	CCAp	M	
Number of external group member identities	4	1	CCAp	M	
External group member identity	variable		CCAp	C	See note 2
SS-CLIR invoked for calling party	1	1	SS	M	
Calling party SSI	24	1	CCAp	M	See notes 3 and 4
Calling party extension	24	1	CCAp	M	See notes 3 and 4
External subscriber number length	5	1	CCAp	M	See note 5
External subscriber number digits	variable		CCAp	C	See note 6
External subscriber number parameters	9		CCAp	C	See note 7
Temporary group member indication	1	1	CCAp	M	See note 8
Temporary group basic migration profile	variable		CCAp	C	See note 9
SS-migration profile	variable		SS	C	See note 10
Dispatcher acceptance	1	1	SS	M	See note 11
Call amalgamation	1	1	CCAp	M	

Information element	Length	Type	Owner	C/O/M	Remark
Number of critical users	4	1	CCAp	M	See note 12
Critical user list	variable		CCAp	C	See note 13
Setup response time-out	4	1	CCAp	M	See note 16
Notification indicator	6	2	SS	O	
Proprietary		3	-	O	
NOTE 1: Conditional on the binary value of the information sub-element "circuit mode type" in the information element "basic service information" being equal to 0 (i.e. the call requested is a speech call).					
NOTE 2: This information element is repeatable and conditional on the information element 'Number of external group member identities'.					
NOTE 3: The calling party identity is used to identify the calling user.					
NOTE 4: In the case of an external incoming call, the calling party SSI and the calling party extension shall be those of the incoming gateway SwMI. The calling party extension is conditional on the calling party type identifier.					
NOTE 5: Shall be equal to 00000 ₂ in the case of inter-TETRA calls, and to N, N being the number of digits of the external calling party number in the case of an external incoming call from PSTN/ISDN/PISN if the calling party identification is delivered by that external network.					
NOTE 6: The number of digits included in this information element shall be equal to N, the value of the external subscriber number length (see note 6), i.e. this information element shall be conditional on the value of N.					
NOTE 7: This information element shall be present only when the external subscriber number length value N is not 00000 ₂ .					
NOTE 8: Indication to the originating SwMI that the calling user is temporarily a member of the called group.					
NOTE 9: Depending on the value of temporary group member indication. The profile shall reflect the actual call being connected.					
NOTE 10: Depending on the value of temporary group member indication. The contents of SS-ISI PROFILE shall be as defined, if applicable, for the supplementary service in each supplementary service sub-part of ETSI EN/ETS 300 392-12 [7].					
NOTE 11: The information element is set when SS-CAD has been invoked for a call and the dispatcher has accepted the call set-up. The information element is used to prevent subsequent invocations of SS-CAD.					
NOTE 12: Equal to 0 when no critical users are identified for the group call.					
NOTE 13: This information element shall be conditional on the information element "Number of critical users" when this value differs from 0. Shall be repeated as a set according to the value of the information element "Number of critical users" when this value is larger than 1.					
NOTE 14: This information element shall be present as defined by the Linking group type identifier information element is set to "Linking group GTSI present".					
NOTE 15: Security level requested by the CSwMI.					
NOTE 16: Refer to clause 4.2.2.3.5.					

The calling party SSI and extension shall correspond to the transmitting party when call is connected unless the ISI-CONNECT PDU contains another calling party.

6.3.1.4 ISI-INFO PDU

When a forward group call request has been queued or the controlling SwMI wishes to inform the originating SwMI of call time-out for the set-up phase before group call set-up, the ISI-INFO PDU shall be sent. The contents and the encoding of this ISI-INFO PDU shall be as defined in table 6.3.

Table 6.3: Contents of ISI-INFO PDU used to send timer information

Information element	Length	Type	Owner	C/O/M	Remark
PDU type	6	1	CCAp	M	ISI-INFO
ISI-INFO type	3	1	CCAp	M	From CSwMI, to OSwMI only
Call time-out, set-up phase	3	2	CCAp	O	
Call status	3	2	CCAp	O	
Notification indicator	6	2	SS	O	
Proprietary		3	-	O	

When the controlling SwMI wishes to inform participating SwMI(s) (and the originating SwMI if it exist) of changed or updated group call information, the ISI-INFO PDU shall be sent containing the relevant information. The contents and the encoding of this ISI-INFO PDU shall be as defined in table 6.4.

The ISI-INFO PDU may be sent to a delaying SwMI when the CSwMI establishes the call. A delaying SwMI is one that has received an ISI-SETUP-INITIATE PDU from the CSwMI, and have responded with an ISI-DELAY PDU but has not yet sent an ISI-SETUP-ACKNOWLEDGE PDU. In this case, the only optional part of the PDU present will be the "call status" field, which will be encoded as "Call connected". The receiving SwMI may choose to expedite the return of its ISI-SETUP-ACKNOWLEDGE PDU so that it may be connected into the call.

Table 6.4: Contents of ISI-INFO PDU used to send call information

Information element	Length	Type	Owner	C/O/M	Remark
PDU type	6	1	CCAp	M	ISI-INFO
ISI-INFO type	3	1	CCAp	M	From CSwMI, updated group information
Reset call time-out timer (T310)	1	1	CCAp	M	
Call time-out	4	2	CCAp	O	
Basic service information	8	2	CCAp	O	
Call status	3	2	CCAp	O	
Call ownership	1	2	CCAp	O	
Poll result identifier	1	2	CCAp	O	See note 1
Poll response percentage	6		CCAp	C	See note 2
Poll response number	6		CCAp	C	See note 2
Group information	2	2	CCAp	O	
Critical connected party SSI	24		CCAp	C	See note 3
Critical connected party extension	24		CCAp	C	See note 3
Notification indicator	6	2	SS	O	
DTMF		3	CCAp	O	
Proprietary		3	-	O	
NOTE 1: Shall be valid for acknowledged group calls only. For other types of calls it shall be set to 0.					
NOTE 2: Depending on the value of poll result identifier.					
NOTE 3: Conditional on the information element Group information is set to value "Call not established to critical user".					

When a participating SwMI wishes to inform the controlling SwMI of SS-information or DTMF digits, the ISI-INFO PDU shall be sent containing the relevant information. The contents and the encoding of this ISI-INFO PDU shall be as defined in table 6.5.

Table 6.5: Contents of ISI-INFO PDU used to send DTMF information

Information element	Length	Type	Owner	C/O/M	Remark
PDU type	6	1	CCAp	M	ISI-INFO
ISI-INFO type	3	1	CCAp	M	From PSwMI
Notification indicator	6	2	SS	O	
DTMF		3	CCAp	O	
Proprietary		3	-	O	

6.3.1.5 ISI-SETUP ACKNOWLEDGE PDU sent by the originating or a participating SwMI - used as a call set-up response

To acknowledge the ISI-SETUP INITIATE PDU, the originating SwMI and participating SwMI(s) shall send an ISI-SETUP ACKNOWLEDGE PDU. By sending this TETRA PDU the originating and participating SwMI(s) confirms that air interface and infrastructure resources are available for connecting the called group.

The contents and the encoding shall be as defined in table 6.6.

The ISI-SETUP-ACKNOWLEDGE PDU is sent from an O/PSwMI when it is ready to receive an ISI-CONNECT PDU from the CSwMI. The reasons used by an O/PSwMI to send in the ISI-SETUP-ACKNOWLEDGE PDU are flexible. The recommended strategy is for the OSwMI to send its ISI-SETUP-ACKNOWLEDGE PDU when it has resources to connect a calling party into the call. The recommended strategy for a PSwMI is for the ISI-SETUP-ACKNOWLEDGE PDU to be sent when it has determined that group party members are present on the SwMI.

The ISI-SETUP-ACKNOWLEDGE PDU is sent by a P/OSwMI in response to an ISI-SETUP-INITIATE PDU. If the receiving SwMI is not able within the received "Setup response time-out" timer to receive an ISI-CONNECT PDU the SwMI shall send an ISI-DELAY PDU or an ISI-REJECT to the CSwMI.

An ISI-SETUP-ACKNOWLEDGE PDU may be sent when an ISI-INFO PDU is received, if the receiving SwMI is delaying, the call is connecting and the SwMI want to be connected into the call.

The conditional fields are required to tell the CSwMI details about a calling party that is eligible to be the calling party of the call (and thus be granted talk permission, if it is the calling party of the call on connection). The conditional fields are used by an OSwMI; a PSwMI never uses them.

Table 6.6: Contents of ISI-SETUP ACKNOWLEDGE PDU sent by the originating or participating SwMI

Information element	Length	Type	Owner	C/O/M	Remark
PDU type	6	1	CCAp	M	ISI-SETUP ACKNOWLEDGE
Basic service information	8	1	CCAp	M	See note 1
Resource allocation	1	1	ANF	M	
Call resource time	3	1	CCAp	M	
Security level at air interface	2	1	CCAp	M	
Group call SwMI type	1	1	CCAp	M	
Speech service requested	3		CCAp	C	See notes 2 and 3
Request to transmit/send data	1		CCAp	C	See note 2
Call priority	4		CCAp	C	See note 2
SS-CLIR invoked for calling party	1		SS	C	See note 2
Group attachment indicator	1		CCAp	C	See notes 2 and 4
Calling party SSI	24		CCAp	C	See notes 2 and 5
Calling party extension	24		CCAp	C	See notes 2 and 5
Calling external subscriber number length	5		CCAp	C	See notes 2 and 6
Calling external subscriber number digits	variable		CCAp	C	See note 7
Calling external subscriber number parameters	9		CCAp	C	See note 8
Speech services supported	5	2	CCAp	O	See note 9
Notification indicator	6	2	SS	O	
Proprietary		3	-	O	
NOTE 1: The binary value of the information sub-element communication type in the information element basic service information may be changed from the value received in either ISI-SETUP INITIATE. The new value shall indicate the communication type supported by the SwMI, if the received value is not supported. All other sub-elements shall be returned unchanged.					
NOTE 2: Conditional on the value of the information sub-element "Group call SwMI type" being equal to "From Originating SwMI".					
NOTE 3: Conditional on the binary value of the information sub-element "circuit mode type" in the information element "basic service information" being equal to 0 (i.e. the call requested is a speech call).					
NOTE 4: This information element shall indicate whether the calling user is attached to the called group in the originating SwMI.					
NOTE 5: In the case of an external incoming call, the calling party SSI and the calling party extension shall be those of the incoming gateway SwMI.					
NOTE 6: Shall be equal to 00000 ₂ in the case of inter-TETRA calls, and to N, N being the number of digits of the external calling party number in the case of an external incoming call from PSTN/ISDN/PISN if the calling party identification is delivered by that external network.					
NOTE 7: The number of digits included in this information element shall be equal to N, the value of the external subscriber number length (see note 5), i.e. this information element shall be conditional on the value of N.					
NOTE 8: This information element shall be present only when the external subscriber number length value N is not 00000 ₂ .					
NOTE 9: This element enables future additions to the TETRA air interface CODEC and may be present only if the value of the information sub-element "Group call SwMI type" is equal to "From Originating SwMI". This information element is not supported in the first edition of the present document.					

6.3.1.6 ISI-DELAY PDU sent by the originating or a participating SwMI - used to delay call set-up

When the originating or a participating SwMI wishes to delay call set-up, the information shall be returned to the controlling SwMI with the following ISI-DELAY PDU. The contents and the encoding of this TETRA PDU shall be as defined in table 6.7.

The ISI-DELAY PDU shall be sent from an O/PSwMI in response to an ISI-SETUP-INITIATE PDU, when it has been determined that an ISI-SETUP ACKNOWLEDGE PDU cannot be sent (because the SwMI is not yet ready to receive an ISI-CONNECT PDU). If the ISI-SETUP ACKNOWLEDGE PDU is available to be sent, then it is sent and no ISI-DELAY PDU is used.

Table 6.7: Contents of ISI-DELAY PDU sent by the originating or a participating SwMI

Information element	Length	Type	Owner	C/O/M	Remark
PDU Type	6	1	CCAp	M	ISI-DELAY
Notification indicator	6	2	SS	O	
Proprietary		3	-	O	

6.3.1.7 ISI-CONNECT PDU sent by the controlling SwMI - used for connecting the call

The contents and the encoding of the ISI-CONNECT PDU sent by the controlling SwMI shall be as defined in table 6.8.

The ISI-CONNECT PDU is sent, by the CSwMI, to connect the call and take the call into the maintenance phase from the call setup phase. When the ISI-CONNECT PDU is sent to all of the SwMIs in the call this is called a "complete" connect, when it is sent to only some of the SwMIs in the group call this is called a "partial" connect. An ISI-CONNECT PDU can only be sent to a SwMI that last sent in an ISI-SETUP-ACKNOWLEDGE PDU.

The CSwMI determines when the call can be connected based on the evidence available to it, both locally, and from the SwMIs in the call. The actual strategy used by the CSwMI to determine when to connect is flexible and therefore implementation dependent. The recommended strategy is for the CSwMI to connect the call when it has an OSwMI (or local calling party) that has sent in an ISI-SETUP-ACKNOWLEDGE PDU and is thus ready to be connected into the call.

Once the call has been connected, the arrival of an ISI-SETUP-ACKNOWLEDGE PDU at the CSwMI will be responded to by an ISI-CONNECT PDU.

Table 6.8: Contents of ISI-CONNECT PDU sent by the controlling SwMI

Information element	Length	Type	Owner	C/O/M	Remark
PDU type	6	1	CCAp	M	ISI-CONNECT
Set-up type	1	1	CCAp	M	
Transmission grant	2	1	ANF	M	
Transmission request permission	1	1	CCAp	M	
Call diverted to dispatcher	1	1	SS	M	See note 1
Security level at air interface	2	1	MM	M	See note 8
Basic service information	8	1	CCAp	M	
Call priority	4	1	CCAp	M	See note 2
Call ownership	1	1	CCAp	M	
Calling party information present	1	1	CCAp	M	
Calling party SSI	24		CCAp	C	See notes 3 and 4
Calling party extension	24		CCAp	C	See notes 3 and 4
Calling external subscriber number length	5		CCAp	C	See notes 3 and 5
Calling external subscriber number digits	Variable		CCAp	C	See note 6
Calling external subscriber number parameters	9		CCAp	C	See note 7
SS-CLIR invoked for calling party	1		SS	C	See note 3
Notification indicator	6	2	SS	O	
Proprietary		3	-	O	
NOTE 1: This indication shall be used to indicate direct call set-up to a dispatcher.					
NOTE 2: The value of the call priority information element may change compared to the call setup initiation due to call amalgamation.					
NOTE 3: Conditional on the value of the "Calling party information present" information element.					
NOTE 4: In the case of an external incoming call, the calling party SSI and the calling party extension shall be those of the incoming gateway SwMI.					
NOTE 5: Shall be equal to 00000 ₂ in the case of inter-TETRA calls, and to N, N being the number of digits of the external calling party number in the case of an external incoming call from PSTN/ISDN/PISN if the calling party identification is delivered by that external network.					
NOTE 6: Conditional on the information element "External subscriber number digits" > 0. Where present the number of digits is equal to N, the value of the information element "External subscriber number length".					
NOTE 7: Conditional on the information element "External subscriber number digits" > 0.					
NOTE 8: Security level required by the CSwMI.					

Upon reception of this TETRA PDU the originating SwMI shall connect the calling user(s) (D-CONNECT PDU sent over the air interface). The originating SwMI's status shall then change from an originating SwMI to a participating SwMI and the called user(s) shall be connected to the group call (a D-SETUP PDU is sent over the air interface).

The participating SwMI(s) shall connect the called user(s) upon reception of this TETRA PDU (a D-SETUP PDU is sent over the air interface).

When a group call is connected (ISI-CONNECT sent to the originating and participating SwMI(s)), only the calling user, identified in the PDU, shall receive transmission permission. If transmission is not granted to the calling user during call set-up, transmission shall only be granted to another user participating in the group call, upon request for transmission from that user.

When several group calls are amalgamated, more than one calling user shall exist. Therefore, it shall be up to the controlling SwMI to decide which calling user shall receive transmission grant, if any.

When two or more calls are amalgamated call ownership is not given to a calling user. The controlling SwMI shall become the call owner.

6.3.1.8 ISI-POLL USER PDU sent by the controlling SwMI - used for polling

The contents and the encoding of the ISI-POLL USER PDU sent by the controlling SwMI shall be as defined in table 6.9.

Table 6.9: Contents of ISI-POLL USER PDU sent by the controlling SwMI

Information element	Length	Type	Owner	C/O/M	Remark
PDU Type	6	1	CCAp	M	ISI-POLL USER
Poll request type	1	1	CCAp	M	
Notification indicator	6	2	SS	O	
Proprietary		3	-	O	

6.3.1.9 ISI-POLL RESPONSE PDU sent by a participating SwMI - used as a polling response

The contents and the encoding of the ISI-POLL RESPONSE PDU sent by a participating SwMI shall be as defined in table 6.10.

Table 6.10: Contents of ISI-POLL RESPONSE PDU sent by a participating SwMI

Information element	Length	Type	Owner	C/O/M	Remark
PDU Type	6	1	CCAp	M	ISI-POLL RESPONSE
Poll request type	1	1	CCAp	M	
Poll response number	6		CCAp	C	See note
Poll response percentage	6		CCAp	C	See note
Notification indicator	6	2	SS	O	
Poll response addresses		3	CCAp	O	
Proprietary		3	-	O	
NOTE: Conditional on the chosen value of the information element poll request type.					

6.3.1.10 ISI-TX DEMAND PDU sent by a participating SwMI - used to request transmission permission

To request transmission permission an ISI-TX DEMAND PDU shall be sent to the controlling SwMI. The contents and the encoding of which shall be as defined in table 6.11.

The ISI-TX DEMAND PDU is sent from a PSwMI to the CSwMI, once the call is in its maintenance phase. It is an indication that the party recorded in the PDU wishes to speak.

Table 6.11: Contents of ISI-TX DEMAND PDU sent to request transmission grant

Information element	Length	Type	Owner	C/O/M	Remark
PDU Type	6	1	ANF	M	ISI-TX DEMAND
TX demand priority	2	1	CCap	M	
Encryption control	1	1	CCap	M	
SS-CLIR invoked for requesting party	1	1	SS	M	
Requesting party SSI	24	1	CCap	M	See note 1
Requesting party extension	24	1	CCap	M	See note 1
Requesting external subscriber number length	5	1	CCap	M	See note 2
Requesting external subscriber number digits	variable		CCap	C	See note 3
Requesting external subscriber number parameter	9		CCap	C	See note 4
Notification indicator	6	2	SS	O	
Proprietary		3	-	O	
NOTE 1: If transmission is granted to an external user then this information element's 24 bits shall be set to 0 or to the gateway address.					
NOTE 2: Shall be equal to 00000 ₂ in the case of inter-TETRA calls, and to N, N being the number of digits of the external calling party number in the case of an external incoming call from PSTN/ISDN/PISN if the calling party identification is delivered by that external network.					
NOTE 3: The number of digits included in this information element shall be equal to N, the value of the external subscriber number length (see note 3), i.e. this information element shall be conditional on the value of N.					
NOTE 4: This information element shall be present only when the external subscriber number length value N is not 00000 ₂ .					

6.3.1.11 ISI-RESOURCE PDU sent by the controlling SwMI - used to request reservation of resources

The ISI-RESOURCE PDU is sent to SwMI(s) with temporary allocated resources, before transmission is granted to a user during the call maintenance phase. The SwMI shall upon reception of this PDU reserve the necessary air interface, mobile and infrastructure resources needed for transmission.

The contents and the encoding of the ISI-RESOURCE PDU sent by the controlling SwMI shall be as defined in table 6.12.

Table 6.12: Contents of ISI-RESOURCE PDU sent by the controlling SwMI

Information element	Length	Type	Owner	C/O/M	Remark
PDU Type	6	1	CCAp	M	ISI-RESOURCE
Notification indicator	6	2	SS	O	
Proprietary		3	-	O	

6.3.1.12 ISI-RESOURCE RESPONSE PDU sent by a participating SwMI - used as a resource response

The ISI-RESOURCE RESPONSE PDU shall indicate the result of resource reservation in a participating SwMI.

The contents and the encoding of the TETRA PDU sent by a participating SwMI shall be as defined in table 6.13.

Table 6.13: Contents of ISI-RESOURCE RESPONSE PDU sent by a participating SwMI

Information element	Length	Type	Owner	C/O/M	Remark
PDU Type	6	1	ANF	M	ISI-RESOURCE RESPONSE
Resource indicator	2	1	ANF	M	
Notification indicator	6	2	SS	O	
Proprietary		3	-	O	

6.3.1.13 ISI-TX CEASED PDU sent by a participating SwMI and a controlling SwMI - used to request/inform cease of transmission

To request cease of transmission, an ISI-TX CEASED PDU shall be sent by the participating SwMI to the controlling SwMI. The PDU shall be sent either to cease an ongoing transmission or to remove a transmission request from the transmission queue.

ISI-TX CEASED is sent from the controlling SwMI to all participating SwMIs indicating that a transmission has been ceased. The PDU shall be sent to indicate that an ongoing transmission has been ceased or that transmission request has been delayed.

The contents and the encoding of the ISI-TX-CEASED PDU in both directions shall be as defined in table 6.14.

Table 6.14: Contents of ISI-TX CEASED PDU sent to request cease of transmission

Information element	Length	Type	Owner	C/O/M	Remark
PDU Type	6	1	ANF	M	ISI-TX CEASED
Transmission ceased	1	1	ANF	M	See note 1
Transmission request permission	1	1	ANF	M	See note 2
Ceasing party SSI	24	1	ANF	M	See note 3
Ceasing party extension	24	1	ANF	M	See note 3
Ceasing external subscriber number length	5	1	CCAp	M	See note 4
Ceasing external subscriber number digits	variable		CCAp	C	See note 5
Ceasing external subscriber number parameter	9		CCAp	C	See note 6
Notification indicator	6	2	SS	O	
Proprietary		3	-	O	

NOTE 1: Used to indicate cause of TX ceased.
NOTE 2: Shall only be valid when this TETRA PDU has been sent from the controlling SwMI.
NOTE 3: If transmission is granted to an external user then this information element's 24 bits shall be set to 0 or to the gateway address.
NOTE 4: Shall be equal to 00000_2 in the case of inter-TETRA calls, and to N, N being the number of digits of the external calling party number in the case of an external incoming call from PSTN/ISDN/PISN if the calling party identification is delivered by that external network.
NOTE 5: The number of digits included in this information element shall be equal to N, the value of the external subscriber number length (see note 5), i.e. this information element shall be conditional on the value of N.
NOTE 6: This information element shall be present only when the external subscriber number length value N is not 00000_2 .

6.3.1.14 ISI-TX GRANTED PDU sent by the controlling SwMI - used to inform grant of transmission

This TETRA PDU is sent from the controlling SwMI as a response to ISI-TX DEMAND. The contents and the encoding of which shall be as defined in table 6.15.

The ISI-TX GRANTED PDU is sent from the CSwMI to PswMIs, during call maintenance. It is used to indicate that:

- Talk permission has been granted to the party recorded in the PDU.
- Talk permission has been granted to another user, the granted party is recorded in the PDU.
- Talk permission has not been granted to the party recorded in the PDU.
- The request to talk, of the party recorded in the PDU, has been queued.

Table 6.15: Contents of ISI-TX GRANTED PDU sent to grant transmission permission

Information element	Length	Type	Owner	C/O/M	Remark
PDU Type	6	1	CCAp	M	ISI-TX GRANTED
Transmission grant	2	1	CCAp	M	
Transmission request permission	1	1	CCAp	M	
Encryption control	1	1	CCAp	M	
SS-CLIR invoked for transmitting party	1	1	SS	M	
Transmitting party SSI	24	1	CCAp	M	See note 1
Transmitting party extension	24	1	CCAp	M	See note 1
Transmitting external subscriber number length	5	1	CCAp	M	See note 2
Transmitting external subscriber number digits	variable		CCAp	C	See note 3
Transmitting external subscriber number parameter	9		CCAp	C	See note 4
Notification indicator	6	2	SS	O	
Proprietary		3	-	O	
NOTE 1: If transmission is granted to an external user then this information element's 24 bits shall be set to 0 or to the gateway address.					
NOTE 2: Shall be equal to 00000 ₂ in the case of inter-TETRA calls, and to N, N being the number of digits of the external calling party number in the case of an external incoming call from PSTN/ISDN/PISN if the calling party identification is delivered by that external network.					
NOTE 3: The number of digits included in this information element shall be equal to N, the value of the external subscriber number length (see note 2), i.e. this information element shall be conditional on the value of N.					
NOTE 4: This information element shall be present only when the external subscriber number length value N is not 00000 ₂ .					

The SwMI containing the indicated transmitting user, shall send an individual addressed D-TX GRANTED PDU over the air interface to this user, upon reception of an ISI-TX GRANTED. A group addressed D-TX GRANTED PDU shall be sent to members of the group call upon reception of the ISI-TX GRANTED with "transmission granted" or "transmission granted to another user" information.

If transmission is granted to an external user then the Transmitting party information element may contain a dummy identifier "all zeros" or the actual gateway address.

6.3.1.15 TETRA PDU sent by the controlling SwMI - used to inform interruption of transmission

When a transmitting user is to be interrupted, the ISI-TX INTERRUPT PDU shall be sent to the participating SwMI(s). The contents and the encoding of which shall be as defined in table 6.16.

The ISI-TX INTERRUPT PDU is used to indicate that, the party recorded in the PDU, has been allocated permission to talk. This is not the party that currently has talk permission.

Table 6.16: Contents of ISI-TX INTERRUPT PDU sent to interrupt transmission

Information element	Length	Type	Owner	C/O/M	Remark
PDU Type	6	1	CCAp	M	ISI-TX INTERRUPT
Transmission grant	2	1	CCAp	M	
Transmission request permission	1	1	CCAp	M	
Encryption control	1	1	CCAp	M	
SS-CLIR invoked for transmitting party	1	1	SS	M	
Transmitting party SSI	24	1	CCAp	M	See note 1
Transmitting party extension	24	1	CCAp	M	See note 1
Transmitting external subscriber number length	5	1	CCAp	M	See note 2
Transmitting external subscriber number digits	Variable		CCAp	C	See note 3
Transmitting external subscriber number parameter	9		CCAp	C	See note 4
Notification indicator	6	2	SS	O	
Proprietary		3	-	O	
NOTE 1: If transmission is granted to an external user then this information element's 24 bits shall be set to 0 or to the gateway address.					
NOTE 2: Shall be equal to 00000 ₂ in the case of inter-TETRA calls, and to N, N being the number of digits of the external calling party number in the case of an external incoming call from PSTN/ISDN/PISN, if the calling party identification is delivered by that external network.					
NOTE 3: The number of digits included in this information element shall be equal to N, the value of the external subscriber number length (see note 2), i.e. this information element shall be conditional on the value of N.					
NOTE 4: This information element shall be present only when the external subscriber number length value N is not 00000 ₂ .					

The SwMI containing the user currently transmitting, shall send an individual addressed D-TX INTERRUPT PDU over the air interface to this user, upon reception of an ISI-TX INTERRUPT. A group addressed D-TX INTERRUPT PDU should be sent to members of the group call upon reception of the ISI-TX INTERRUPT.

The SwMI containing the granted user, should send an individual addressed D-TX GRANTED PDU over the air interface to this user, after the group addressed D-TX INTERRUPT PDU has been sent.

6.3.1.16 ISI-TX CONTINUE PDU sent by a participating SwMI - used to inform of continuation in an active group call

When a participating SwMI continues with an active group call that it previously had withdrawn from, the controlling SwMI shall be informed. It is then up to the CC application of the controlling SwMI to determine if any actions shall be taken.

The contents and the encoding of which shall be as defined in table 6.17.

Table 6.17: Contents of ISI-TX-CONTINUE PDU sent by a participating SwMI

Information element	Length	Type	Owner	C/O/M	Remark
PDU Type	6	1	CCAp	M	ISI-TX CONTINUE
Participating SwMI MNI	24	1	CCAp	M	
Notification indicator	6	2	SS	O	
Proprietary		3	-	O	

6.3.1.17 ISI-TX WAIT PDU sent by a participating SwMI - used to inform of withdrawal from an active group call

When a participating SwMI withdraws from an active group call, the controlling SwMI shall be informed. It is then up to the CC application of the controlling SwMI to determine if any actions shall be taken.

The contents and the encoding of which shall be as defined in table 6.18.

Table 6.18: Contents of TETRA PDU sent by a participating SwMI

Information element	Length	Type	Owner	C/O/M	Remark
PDU Type	6	1	CCAp	M	ISI-TX WAIT
Participating SwMI MNI	24	1	CCAp	M	
Notification indicator	6	2	SS	O	
Proprietary		3	-	O	

6.3.1.18 ISI-REJECT PDU

If an group call setup request cannot be accepted by a SwMI, the ISI-REJECT PDU shall be returned to the requesting SwMI. This may happen in the following cases:

- When an ISI-SETUP INITIATE cannot be accepted by the originating SwMI, the ISI-REJECT PDU shall be returned to the controlling SwMI.
- When a ISI-ORIGINATING SETUP cannot be accepted by either the group home SwMI or the group linking controlling SwMI.
- When an ISI-SETUP INITIATE PDU cannot be accepted by a participating SwMI.

The contents and the encoding of this ISI-REJECT PDU shall be as defined in table 6.19.

Table 6.19: Contents of ISI-REJECT PDU sent by the originating SwMI

Information element	Length	Type	Owner	C/O/M	Remark
PDU Type	6	1	CCAp	M	ISI-REJECT
Reject cause	6	1	CCAp	M	
Notification indicator	6	2	SS	O	
Proprietary		3	-	O	

6.3.1.19 ISI-DISCONNECT PDU sent by the originating SwMI or a participating SwMI - used to disconnect from the call

The contents and the encoding of the ISI-DISCONNECT PDU sent by the originating SwMI or a participating SwMI shall be as defined in table 6.20.

The ISI-DISCONNECT PDU is sent to the CSwMI by P/OSwMIs. It may be sent when a calling party disconnects, or when a SwMI wishes to leave the call. The only mandatory use of the PDU is during call setup when an OSwMI changes into a PSwMI, because its entire set of calling parties no longer wish to be in the call.

When the ISI-DISCONNECT PDU is received the CSwMI determines if the sending SwMI shall remain in the call or if the sending SwMI shall be removed from call, in which case it will send ISI-RELEASE PDU to that SwMI. The CSwMI could, alternatively, decide to terminate the call at all SwMIs. If it chooses this course of action, an ISI-RELEASE PDU is sent to all SwMIs.

Table 6.20: Contents of ISI-DISCONNECT PDU sent by the originating SwMI or a participating SwMI

Information element	Length	Type	Owner	C/O/M	Remark
PDU Type	6	1	CCAp	M	ISI-DISCONNECT
Call owner request	1	1	CCAp	M	
Disconnect cause	6	1	CCAp	M	
Notification indicator	6	2	SS	O	
Proprietary		3	-	O	

6.3.1.20 ISI-RELEASE PDU sent by the controlling SwMI

The contents and the encoding of the ISI-RELEASE PDU sent by the controlling SwMI shall be as defined in table 6.21.

The ISI-RELEASE PDU is sent from the CSwMI. There are two different uses of the ISI-RELEASE PDU.

The first use is when the "disconnect type" field is set to "delay group call setup". This is used when the CSwMI has decided to delay the set up of the call. The CSwMI may choose to delay the set up of the call when it does not have the conditions it needs to connect the call. The ISI-RELEASE PDU (delay group call setup) can only be sent to a SwMI that has returned an ISI-SETUP-ACKNOWLEDGE PDU to the CSwMI. A SwMI that receives an ISI-RELEASE PDU (delay group call setup) can use the knowledge of the delay of the call as it chooses. For example, the SwMI may decide to release any resources it has already reserved so that the call could be connected, or it may choose to do nothing.

The second use of an ISI-RELEASE PDU is when the "disconnect type" is set to a value other than "delay group call setup". Uses in this sense are as follows:

- The ISI-RELEASE PDU is used as a response to an ISI-DISCONNECT PDU.
- The ISI-RELEASE PDU can be sent, unilaterally, by the CSwMI to any SwMI that it wants to remove from the call.

Table 6.21: Contents of ISI-RELEASE PDU sent by the controlling SwMI

Information element	Length	Type	Owner	C/O/M	Remark
PDU Type	6	1	CCAp	M	ISI-RELEASE
Disconnect type	2	1	CCAp	M	
Disconnect cause	6		CCAp	C	See note
Notification indicator	6	2	SS	O	
Proprietary		3	-	O	
NOTE:	This information element shall be present only when the value of the information element "Disconnect type" is other than "delay group call set-up".				

6.3.1.21 ISI-REROUTE PDU sent by the group home SwMI or the linking controlling SwMI - used to re-route the call

The contents and the encoding of the TETRA PDU sent by the group home SwMI or the linking controlling SwMI shall be as defined in table 6.22.

Table 6.22: Contents of ISI-REROUTE PDU sent by the group home SwMI or the linking controlling SwMI

Information element	Length	Type	Owner	C/O/M	Remark
PDU Type	6	1	CCAp	M	ISI-REROUTE
Forwarded-to group address SSI	24	1	CCAp	M	
Group/Linking home SwMI MNI	24	1	ANF	M	
Notification indicator	6	2	SS	O	
Proprietary		3	-	O	

6.3.2 TETRA PDU information element coding

6.3.2.1 General about the TETRA PDU Information Encoding

The majority of information elements included in the TETRA PDU definitions in clause 6.3.1 are equal to those defined for the air interface PDUs - see clause 14.8 of ETSI EN 300 392-2 [1] for these definitions. However, a few ISI specific information elements have been included.

NOTE: A given PDU information element already defined for the air interface may or may not take all its possible values when used in ISI TETRA PDUs.

6.3.2.2 Additional information to existing information element at the ISI

6.3.2.2.1 Call status

An extra value is defined above that defined in clause 14.8.13 of ETSI EN 300 392-2 [1] for the exclusive use of ANF-ISIGC.

An ISI-INFO is sent by the CSwMI to any SwMI that is still delaying when the call connects. The CSwMI indicates "call_connected" to these SwMIs.

Table 6.23: Call status, information element

Information element	Length	Value	Remark
Call status	3	000 ₂	Call is progressing
		001 ₂	Call is queued
		010 ₂	Requested subscriber is paged
		011 ₂	Call Continue
		100 ₂	Hang time expired
		101 ₂	Call connected, note
		110 ₂	Reserved
		111 ₂	Reserved
NOTE: Only used for ANF-ISIGC by a CSwMI that has connected the call, and needs to inform delaying SwMIs of this fact.			

6.3.2.2.2 Call time-out, set-up phase

As opposed to the definition for the air interface protocol (clause 14.8.17 of ETSI EN 300 392-2 [1]) this information element is not be used to set the call time-out timer, for the set-up phase at the air interface of the calling user (T302). It is simply used to inform the originating SwMI of the call set-up time used by the controlling SwMI during the set-up phase.

NOTE 1: It is up to the originating SwMI to decide if the relevant timer in the MS should be equivalent to or greater than the received value.

NOTE 2: Refer to an alternative (the Setup response time-out information element) defined in clause 6.3.2.3.31.

The coding of this information element, is the same as defined in clause 14.8.17 of ETSI EN 300 392-2 [1]. However, no predefined value is used (i.e. the value 000₂ is reserved). The coding shall be as defined in table 6.24.

Table 6.24: Call time-out, set-up phase information element contents

Information element	Length	Value	Remark
Call time-out, set-up phase	3	000 ₂	Reserved
		001 ₂	1 s
		010 ₂	2 s
		011 ₂	5 s
		100 ₂	10 s
		101 ₂	20 s
		110 ₂	30 s
		111 ₂	60 s

6.3.2.2.3 Call time-out

This information element is also only used to inform the originating and participating SwMI(s) of the call length time used by the controlling SwMI during the maintenance phase of the call.

NOTE: It is up to the originating and participating SwMI(s) to decide if the relevant timer in the MS should be equivalent to or greater than the received value.

The coding of this information element, shall be as defined in clause 14.8.16 of ETSI EN 300 392-2 [1].

6.3.2.2.4 Disconnect cause information element

The purpose of the disconnection cause information element is to inform either the participating SwMI(s) or the controlling SwMI of the reason for the release/disconnection. This information element shall be coded as defined in table 6.25.

Table 6.25: Disconnect cause information element contents

Information element	Length	Value	Remark
Disconnect cause	6	0XXXXX ₂	Air Interface disconnect causes
		000000 ₂	Refer to ETSI EN 300 392-2 [1], see note
		etc.	etc.
		011111 ₂	Refer to ETSI EN 300 392-2 [1], see note
		1XXXXX ₂	ISI specific disconnection causes
		100000 ₂	Reserved for ANF-ISIIC, see ETSI TS 100 392-3-12 [3], clause 6.3.2.1.4
		etc.	etc.
		101111 ₂	Reserved for ANF-ISIIC, see ETSI TS 100 392-3-12 [3], clause 6.3.2.1.4
		110000 ₂	Call not established to critical user
		110001 ₂	Call could not be restored to call owner
		110010 ₂	No resources for group call
		110011 ₂	No participants
		110100 ₂	Unknown group identity
		110101 ₂	Expiry of timer
		110110 ₂	Reserved for other ANF-ISIGC disconnection causes
		etc.	etc.
		111110 ₂	Reserved for other ANF-ISIGC disconnection causes
111111 ₂	Reserved		
NOTE: All values 0XXXXX ₂ shall be as defined in clause 14.8.18 of ETSI EN 300 392-2 [1] for the same values (XXXXX ₂).			

6.3.2.2.5 Temporary group basic migration profile

The group basic migration profile is defined in ETSI TS 100 392-3-15 [4]. The profile status shall indicate that this is a temporary profile only to be used for the duration of the call. The profile shall only be valid for the temporary group member.

6.3.2.2.6 PDU type

The purpose of the PDU type information element is to identify the type of TETRA PDU sent over the ISI. This information element shall be coded as defined in table 6.26.

NOTE 1: A PDU type value exist for each TETRA PDU.

Table 6.26: PDU type information element contents

Information element	Length	Value	Remark
PDU Type	6	000000 ₂	Reserved
		etc.	etc.
		100000 ₂	Reserved
		100001 ₂	ISI-ORIGINATING SETUP (see table 6.1)
		100010 ₂	ISI-SETUP INITIATE (see table 6.2)
		100011 ₂	ISI-SETUP ACKNOWLEDGE (see table 6.6)
		100100 ₂	ISI-CONNECT (see table 6.8)
		100101 ₂	ISI-INFO (see table 6.3, table 6.4 and table 6.5)
		100110 ₂	ISI-REROUTE (see table 6.22)
		100111 ₂	ISI-DELAY (see table 6.7)
		101000 ₂	ISI-POLL USER (see table 6.9)
		101001 ₂	ISI-POLL RESPONSE (see table 6.10)
		101010 ₂	ISI-REJECT (see table 6.19)
		101011 ₂	ISI-DISCONNECT (see table 6.20)
		101100 ₂	SI-RELEASE (see table 6.21)
		101101 ₂	Reserved
		101110 ₂	Reserved
		101111 ₂	Reserved
		110000 ₂	ISI-TX DEMAND (see table 6.11)
		110001 ₂	Reserved
		110010 ₂	ISI-TX GRANTED (see table 6.15)
		110011 ₂	ISI-TX INTERRUPT (see table 6.16)
		110100 ₂	ISI-TX CEASED (see table 6.14)
		110101 ₂	ISI-RESOURCE (see table 6.12)
		110110 ₂	ISI-RESOURCE RESPONSE (see table 6.13)
		110111 ₂	ISI-TX WAIT (see table 6.18)
		111000 ₂	ISI-TX CONTINUE (see table 6.17)
111001 ₂	Reserved		
etc.	etc.		
111111 ₂	Reserved		

NOTE 2: 6 bits are used for encoding the PDU type information element. This is one more bit than what is used at the air interface for the PDU type information element. The PDU types having the binary values 000000₂ to 011111₂ correspond to the values of the downlink PDUs defined in clause 14.8.28 of ETSI EN 300 392-2 [1] while the binary values from 100000₂ to 111111₂ are used as ISI specific definitions.

6.3.2.2.7 SS-migration profile

The SS-migration profile is defined in ETSI TS 100 392-3-15 [4]. The profile shall reflect the actual call being connected. The profile status shall indicate that this is a temporary profile only to be used for the duration of the call. The profile shall only be valid for the temporary group member.

6.3.2.3 New information elements used at the ISI

6.3.2.3.1 Call amalgamation

Call amalgamation information element shall be encoded as defined in table 6.27.

Table 6.27: Call amalgamation, information element

Information element	Length	Value	Remark
Call amalgamation	1	0	Call has not been amalgamated
		1	Call has been amalgamated

6.3.2.3.2 Call diverted to dispatcher

This information element shall be coded as defined in table 6.28.

Table 6.28: Call diverted to dispatcher information element contents

Information element	Length	Value	Remark
Call diverted to dispatcher	1	0	Call not diverted to a dispatcher
		1	Call diverted to a dispatcher

6.3.2.3.3 Call owner request

This information element shall be coded as defined in table 6.29.

Table 6.29: Call owner request information element contents

Information element	Length	Value	Remark
Call owner request	1	0	Call owner has not requested disconnect
		1	Call owner requested disconnect

6.3.2.3.4 Call resource time-out

This information element is used to inform the controlling SwMI of the call resource time-out timer. This timer shall indicate the period of time the participating/originating SwMI shall hold resources reserved within the SwMI.

The coding of this information element, shall be as defined in table 6.30.

Table 6.30: Call resource time-out information element contents

Information element	Length	Value	Remark
Call resource time-out	3	000 ₂	Reserved
		001 ₂	5 s
		010 ₂	10 s
		011 ₂	15 s
		100 ₂	20 s
		101 ₂	25 s
		110 ₂	30 s
		111 ₂	Reserved

6.3.2.3.5 Calling group identifier

This information element shall be coded as defined in table 6.31.

Table 6.31: Calling group identifier information element contents

Information element	Length	Value	Remark
Calling group identifier	1	0	Calling group GTSI not present
		1	Calling group GTSI present

6.3.2.3.6 Calling party information present

This information element shall be coded as defined in table 6.32.

Table 6.32: Calling party information present information element contents

Information element	Length	Value	Remark
Calling party information present	1	0	Calling party information is not present
		1	Calling party information is present

6.3.2.3.7 Connected party SSI and extension

The coding of these information elements shall be the same as defined in clauses 14.8.11 and 14.8.10 of ETSI EN 300 392-2 [1]. The information element shall always identify a group of subscriber (TETRA group identity).

6.3.2.3.8 Controlling/originating/participating SwMI MNI

This information element shall be coded as defined in table 6.33.

Table 6.33: Controlling/group home/linking home/originating/participating SwMI MNI information element contents

Information element	Length	Value	Remark
Country Code	10		See ETSI EN 300 392-1 [10], clause 7
Network Code	14		See ETSI EN 300 392-1 [10], clause 7

6.3.2.3.9 Critical connected party/requesting party/transmitting party SSI and extension

The coding of these information elements shall be the same as defined in clauses 14.8.11 and 14.8.10 of ETSI EN 300 392-2 [1]. The information element shall always identify an individual subscriber.

6.3.2.3.10 Critical user list

This information element shall be coded as defined in table 6.34.

Table 6.34: Critical user list element contents

Information element	Length	Type	Owner	C/O/M	Remark
Critical connected party SSI	24	1	CCAp	M	See clause 6.3.2.3.9 for definition
Critical connected party extension	24	1	CCAp	M	See clause 6.3.2.3.9 for definition

6.3.2.3.11 Disconnect type

This information element shall be coded as defined in table 6.35.

Table 6.35: Disconnect type information element contents

Information element	Length	Value	Remark
Disconnect type	2	00 ₂	Full disconnection of call
		01 ₂	Partial disconnection of call
		10 ₂	Delay group call set-up
		11 ₂	Reserved

6.3.2.3.12 Dispatcher acceptance

This information element shall be coded as defined in table 6.36.

Table 6.36: Dispatcher acceptance information element contents

Information element	Length	Value	Remark
Dispatcher acceptance	1	0	SS-CAD has not been invoked
		1	The dispatcher has accepted the call

6.3.2.3.13 External group member identity

This information element shall be coded as defined in table 6.37.

Table 6.37: External group member identity information element contents

Information element	Length	Type	Owner	C/O/M	Remark
External subscriber number length	5	1	CCAp	M	See table 6.39 for definition - see note 1
External subscriber number digits	variable		CCAp	C	See table 6.38 for definition - see note 2
External subscriber number parameter	9		CCAp	C	See table 6.40 for definition - see note 3
NOTE 1: Shall be equal to 00000 ₂ in the case of inter-TETRA calls, and to N, N being the number of digits of the external calling party number in the case of an external incoming call from PSTN/ISDN/PISN if the calling party identification is delivered by that external network.					
NOTE 2: The number of digits included in this information element shall be equal to N, the value of the external subscriber number length (see note 1), i.e. this information element shall be conditional on the value of N.					
NOTE 3: This information element shall be present only when the external subscriber number length value N is not 00000 ₂ .					

6.3.2.3.14 External subscriber number digits

The information element external subscriber number digits is a binary string with a length equal to 4 times N, where N is equal to the value of the information element 'external subscriber number length'. The 'external subscriber number length' information element shall always precede the "external subscriber number digits" in TETRA PDUs. The first 4 bits of the binary string shall be the coded value of the first digit (or symbol) of the external subscriber number, the next four bits shall be the coded value of the second digit (or symbol), and so on forth until the Nth digit has been coded.

Each digit of the external subscriber number shall be coded as defined in ETSI EN 300 392-2 [1], clause 14.8.20. According to that each digit is coded into its binary value using 4 bits, the "*" sign shall be coded as "1010₂", the "#" as "1011₂" and the "+" as "1100₂", and the remaining binary values "1101₂", "1110₂" and "1111₂" are reserved. The order of these digits shall be that in which they would be dialled: the first one would then be entered first, and so on.

Table 6.38 illustrates this definition.

Table 6.38: External subscriber number digits information element contents

Information element	Length	Value
External subscriber number digits	4 × N	(xxxx ₂) (xxxx ₂) (xxxx ₂) (xxxx ₂) etc. 1 st digit 2 nd digit 3 rd digit 4 th digit

6.3.2.3.15 External subscriber number length

This information element shall be coded as defined in table 6.39.

Table 6.39: External subscriber number length information element contents

Information element	Length	Value	Remark
External subscriber number length	5	00000 ₂	See note 1
		XXXXX ₂	See note 2
NOTE 1: The presence of the information element "external subscriber number digits" shall be conditional on the value of this information element being different from 0.			
NOTE 2: The number of digits in the information element "external subscriber number digits" shall be equal to N, the decimal number corresponding to the binary value XXXXX ₂ .			

NOTE: The external subscriber number length is needed according to the PDU encoding rules defined in clause 14.7 of ETSI EN 300 392-2 [1], for encoding the number digits (the length of which is variable) as "a type 1 element".

6.3.2.3.16 External subscriber number parameters

This information element external subscriber number parameter in the case of interworking shall be encoded as defined in table 6.40.

Table 6.40: External subscriber number parameters information element contents

Information element	Length	Type	Owner	C/O/M	Remark
Numbering plan identifier	4	1	CCAp	M	See table 6.46 for definition
Type of Number	3	1	ANF	M	See table 6.60 for definition
Screening indicator	2	1	SS	M	See table 6.51 for definition

6.3.2.3.17 Group attachment indicator

This information element shall be coded as defined in table 6.41.

Table 6.41: Group attachment indicator information element contents

Information element	Length	Value	Remark
Group attachment indicator	1	0	The calling user has attached to the called group
		1	The calling user has not attached to the called group

6.3.2.3.18 Group call SwMI type

This information element shall be coded as defined in table 6.42.

Table 6.42: Group call SwMI type, information element contents

Information element	Length	Value	Remark
Group call SwMI type	1	0	From Originating SwMI
		1	From Participating SwMI
NOTE 1: An Originating SwMI is a SwMI that has sent in an ISI-Originating Setup to the CSwMI.			
NOTE 2: A Participating SwMI is a SwMI been invited to the group call (has not sent ISI-Originating Setup).			

6.3.2.3.19 Group information

This information element group information shall be encoded as defined in table 6.43.

Table 6.43: Group information element contents

Information element	Length	Value	Remark
Group information	2	0	Reserved
		1	Call not established to critical user
		2	Reserved
		3	Reserved

6.3.2.3.20 ISI-INFO type

The ISI-INFO type information element is used to assist in the decoding of ISI-Info PDUs. The present document contains three such ISI-Info PDUs, each of which is defined differently. This information element allows the decoder to determine what type of ISI-Info PDU is being decoded. The ISI-INFO type information element shall be coded as defined in table 6.44.

Table 6.44: ISI-INFO type, information element

Information element	Length	Value	Remark
ISI-INFO type	3	000 ₂	From CSwMI, to OSwMI only
		001 ₂	From CSwMI, updated group information
		010 ₂	From PSwMI
		011 ₂	Reserved
		100 ₂	Reserved
		101 ₂	Reserved
		110 ₂	Reserved
		111 ₂	Reserved

6.3.2.3.21 Linking group type identifier

This information element shall be coded as defined in table 6.45.

Table 6.45: Linking group type identifier information element contents

Information element	Length	Value	Remark
Linking group type identifier	1	0	Linking group GTSI not present
		1	Linking group GTSI present

6.3.2.3.22 Numbering plan identifier

This information element shall be coded as defined in table 6.46.

Table 6.46: Numbering plan identifier information element contents

Information element	Length	Value	Remark
Numbering plan identification	4	0000 ₂	Unknown
		0001 ₂	PSTN/ISDN/GSM (see note 1)
		0010 ₂	Reserved
		0011 ₂	Data Numbering Plan (see note 2)
		0100 ₂	Reserved (Telex)
		0101 ₂	Reserved
		etc.	etc.
		0111 ₂	Reserved
		1000 ₂	National standard numbering plan
		1001 ₂	Private numbering plan
		1010 ₂	Reserved for extension
		etc.	etc.
		1111 ₂	Reserved for extension
NOTE 1: See Recommendation ITU-T E.164 [i.4].			
NOTE 2: See Recommendation ITU-T X.121 [i.5].			

6.3.2.3.23 Poll request type

This information element shall be coded as defined in table 6.46.

Table 6.46: Poll request type information element contents

Information element	Length	Value	Remark
Poll request type	1	0	Poll response number wanted
		1	Poll response percentage wanted

6.3.2.3.24 Poll result identifier

This information element shall be coded as defined in table 6.47.

Table 6.47: Poll result identifier information element contents

Information element	Length	Value	Remark
Poll result identifier	1	0	Poll response number given
		1	Poll response percentage given

6.3.2.3.25 Reject cause information element

The purpose of the reject cause information element is to inform either the originating SwMI or the controlling SwMI of the reason for rejection. This information element shall be coded as defined in table 6.48.

Table 6.48: Reject cause information element contents

Information element	Length	Value	Remark
Reject cause	6	0XXXXX ₂	Air Interface disconnect causes
		000000 ₂	Refer to ETSI EN 300 392-2 [1], see note
		etc.	etc.
		011111 ₂	Refer to ETSI EN 300 392-2 [1], see note
		1XXXXX ₂	ISI specific reject causes
		100000 ₂	Reserved
		etc.	etc.
		101111 ₂	Reserved
		110000 ₂	Reserved
		110001 ₂	Reserved
		110010 ₂	No resources for group call
		110011 ₂	No participants
		110100 ₂	Unknown group identity
		110101 ₂	Reserved
		110110 ₂	Reserved
		110111 ₂	Reserved
		111000 ₂	No resources for calling party or calling party disconnected
		111001 ₂	Reserved
		111010 ₂	Reserved
		111011 ₂	Call rejected by the originating/participating SwMI
111100 ₂	Reserved		
111101 ₂	Reserved		
111110 ₂	Reserved		
111111 ₂	Reserved (extension)		
NOTE: All values 0XXXXX ₂ shall be as defined in clause 14.8.18 of ETSI EN 300 392-2 [1] for the same values (XXXXX ₂).			

6.3.2.3.26 Resource allocation

This information element shall be coded as defined in table 6.49.

Table 6.49: Resource allocation information element contents

Information element	Length	Value	Remark
Resource allocation	1	0	Permanently allocated resources
		1	Temporary allocated resources

6.3.2.3.27 Resource indicator

This information element shall be coded as defined in table 6.50.

Table 6.50: Resource indicator information element contents

Information element	Length	Value	Remark
Resource indicator	2	0	Resources are reserved
		1	Resources could not be reserved
		2	Resources could not be reserved, delay requested
		3	Reserved

6.3.2.3.28 Screening indicator

This information element shall be coded as defined in table 6.51.

Table 6.51: Screening indicator information element contents

Information element	Length	Value	Remarks
Screening indicator	2	00 ₂	User provided, not screened
		01 ₂	User provided, verified and passed
		10 ₂	User provided, verified and failed
		11 ₂	Network provided

6.3.2.3.29 Security level at air interface

This information element shall be coded as defined in table 6.52. The security classes shall be as defined clause 6.2 of ETSI EN 300 392-7 [5].

Table 6.52: Security level information element contents

Information element	Length	Value	Remark
Security level at air interface	2	00 ₂	Class 1
		01 ₂	Class 2: SCK Mode
		10 ₂	Class 3: DCK Mode
		11 ₂	Reserved

6.3.2.3.30 Setup response time-out

The Setup response time-out information element shall be coded as defined in table 6.53.

Table 6.53: Setup response time-out information element contents

Information element	Length	Value	Remark
Setup response time-out	4	0000 ₂	Reserved
		0001 ₂	1 s
		0010 ₂	2 s
		0011 ₂	3 s
		0100 ₂	4 s
		0101 ₂	5 s
		0110 ₂	6 s
		0111 ₂	7 s
		1000 ₂	8 s
		1001 ₂	9 s
		1010 ₂	10 s
		1011 ₂	11 s
		1100 ₂	12 s
		1101 ₂	13 s
		1110 ₂	14 s
1111 ₂	15 s		

6.3.2.3.31 Set-up type

This information element shall be coded as defined in table 6.54.

Table 6.54: Set-up type information element contents

Information element	Length	Value	Remark
Set-up type	2	0	Complete set-up of group call
		1	Partial set-up of group call

6.3.2.3.32 Speech service chosen/requested/used

This information element shall be coded as defined in table 6.55.

Table 6.55: Speech service chosen/requested/used information element contents

Information element	Length	Value	Remark
Speech service chosen/ requested/used	3	000 ₂	CODEC defined in ETSI EN 300 395-2 [8]
		xx1 ₂	Reserved
		x10 ₂	Reserved
		100 ₂	Reserved

6.3.2.3.33 Speech services supported

This information element is a bit-map field indicating which TETRA CODEC are supported. The meaning of each bit setting in this information element shall be as defined in table 6.56.

NOTE: This information element is not supported in the first edition of the present document.

Table 6.56: Speech services supported information element contents

Information element	Length	Value	Remark
Speech services supported	5	00000 ₂	Reserved
		00001 ₂	CODEC defined in ETSI EN 300 395-2 [8] supported
		00010 ₂	Reserved
		00100 ₂	Reserved
		01000 ₂	Reserved
		10000 ₂	Reserved

6.3.2.3.34 SS-CLIR invoked for calling/transmitting/restoring/connected party

This information element shall be coded as defined in table 6.57.

Table 6.57: SS-CLIR invoked for calling/transmitting/connected party information element contents

Information element	Length	Value	Remark
SS-CLIR invoked for calling/transmitting/connected party	1	0	SS-CLIR not invoked for the party
		1	SS-CLIR invoked for the party

6.3.2.3.35 Temporary group member indication

This information element shall be coded as defined in table 6.58.

Table 6.58: Temporary group member indication information element contents

Information element	Length	Value	Remark
Temporary group member indication	1	0	The calling or indicated user is a member of the group
		1	The calling or indicated user is a temporary member of the group

6.3.2.3.36 Transmission Ceased

This information element shall be used to inform participating SwMIs of the reason for transmission cease.

Table 6.59: Transmission ceased information element contents

Information element	Length	Value	Remark
Transmission ceased	1	0	Cease current transmission
		1	Delay transmission request

6.3.2.3.37 Type of number

This information element shall be coded as defined in table 6.60.

Table 6.60: Type of number information element contents

Information element	Length	Value	Remarks
Type of number, (note)	3	000 ₂	Unknown/unknown
		001 ₂	International number/level 2 regional number
		010 ₂	National number/level 1 regional number
		011 ₂	Network specific number/PISN specific number
		100 ₂	Abbreviated number/level 0 regional number
		101 ₂	Reserved for extension
		etc.	etc.
		111 ₂	Reserved for extension
NOTE: This parameter is the meaning of the information element type of number as defined in ISO/IEC 11571 [9] when the numbering plan identification is the private numbering plan (i.e. binary value of the information sub-element equal to 1001 ₂).			

6.4 ANF-ISIGC state definitions

6.4.1 States at the originating SwMI

6.4.1.1 IDLE

This is the initial state for the originating SwMI ANF-ISIGC entity. In this state FE1 shall:

- upon request from the CC application, fetch and analyse the calling users profile information;
- analyse the destination group identity (GTSI) and evaluate if an inter-TETRA connection needs to be established for the call set-up request;
- obtain routeing information to the group home SwMI and route the call over an inter-TETRA connection.

From this state FE1 can go to state FORWARD CALL.

6.4.1.2 FORWARD CALL

This is the state where the originating SwMI ANF-ISIGC entity waits for approval or rejection of the call set-up request. In this state FE1 should:

- receive information about call status and the call set-up time used by the controlling SwMI and forward this information to the originating SwMI CC application.

In this state FE1 shall:

- either receive information that the call set-up request has been rejected by the group home/controlling SwMI and forward this information to the originating SwMI CC application; or
- receive set-up information from the controlling SwMI and forward this information to the originating SwMI CC application;
- receive information from the originating SwMI CC application that either:
 - the call is ready for through connect and forward this information to the controlling SwMI; or
 - start timer T2 as indicated in clause 6.7;
 - the call has been rejected and forward this information to the controlling SwMI; or

- the CC application wishes to delay the call set-up and forward this information to the controlling SwMI (this is not valid for a call set-up initiated by an external user);
- release reserved resources upon expiration of timer T2.

In this state FE1 may:

- receive a request to re-route the call set-up request from the group home SwMI to either the linking controlling SwMI or to a new group home SwMI (when SS-CFU has been invoked).

From this state FE1 can go to state WAIT CONNECT or IDLE.

6.4.1.3 WAIT CONNECT

This is the state where call set-up has been initiated and the originating SwMI ANF-ISIGC entity is waiting for the call to be through connected. In this state FE1 shall:

- receive indication that the calling user is to be through connected and forward this information to the originating SwMI CC application:
 - change status from an originating SwMI to a participating SwMI. The originating shall become idle;
- receive indication that the call is to be delayed and forward this information to the originating SwMI CC application:
 - receive indication that the originating SwMI CC application has accepted the delay and forward this information to the controlling SwMI.

In this state FE1 may:

- receive indication that this SwMI is being released from the call and forward this information to the originating SwMI CC application;
- receive information from the originating SwMI CC application that the call is to be disconnected in the originating SwMI and forward this information to the controlling SwMI.

From this state FE1 can go to state IDLE, DELAY GROUP CALL, CALL RELEASE or CALL DISCONNECT.

6.4.1.4 DELAY GROUP CALL

This is the state where the originating SwMI ANF-ISIGC entity has been delayed during call set-up. In this state FE1 shall:

- receive indication that this SwMI is being released from the call and forward this information to the originating SwMI CC application; or
- receive information from the originating SwMI CC application that the call is to be disconnected in the originating SwMI and forward this information to the controlling SwMI; or
- receive set-up information from the controlling SwMI and forward this information to the originating SwMI CC application. The call is no longer delayed. As a result of the call setup continuation FE1 shall:
 - receive information from the originating SwMI CC application that the call is ready for through connect and forward this information to the controlling SwMI;
 - receive information from the originating SwMI CC application that the CC application wishes to delay the call set-up and forward this information to the controlling SwMI.

From this state FE1 can go to state WAIT CONNECT, CALL RELEASE or CALL DISCONNECT.

6.4.1.5 CALL DISCONNECT

The originating SwMI ANF-ISIGC entity is in this state when the CC application has made a request to be disconnected from the call. In this state FE1 shall:

- receive indication that this SwMI is being released from the call and forward this information to the originating SwMI CC application.

From this state FE1 can go to state CALL RELEASE.

6.4.1.6 CALL RELEASE

This is the state where the call is being released within the originating SwMI. This state may be used to collect call information, before the call is completely released. In this state FE1 shall:

- wait for confirmation from the originating SwMI CC application that release has been performed;
- complete the release the ANF-ISIGC (inter-TETRA) connection.

From this state FE1 can go to state IDLE.

6.4.2 States at the controlling SwMI

6.4.2.1 IDLE

This is the initial state for the controlling SwMI ANF-ISIGC entity. In this state FE2 shall:

- receive a request for group call set-up from an originating SwMI and forward this information to the controlling SwMI CC application;
- upon call set-up acceptance from the CC application:
 - fetch and analyse the called groups routing information and evaluate if the group is linked;
 - obtain routing information to the linking controlling SwMI if this is not to be the controlling SwMI for the call;
 - inform the originating SwMI that the call set-up request shall be re-routed, due to group linking or call forwarding unconditionally if this has occurred;
 - merge this call request to an already active call;
 - analyse the migration information for the group and evaluate if any inter-TETRA connection needs to be established for the call set-up;
 - obtain routing information to the participating SwMI(s) and route the call over an inter-TETRA connection to the originating SwMI and the participating SwMI(s);
- upon call set-up rejection from the CC application inform the originating SwMI that the call cannot be performed.

In this state FE2 should:

- send call status and call time out information for the set-up phase, to the originating SwMI.

From this state FE2 can go to state GROUP CALL INITIATE.

6.4.2.2 GROUP CALL INITIATE

This is the state used by the controlling SwMI ANF-ISIGC entity when waiting for call set-up responses from the originating and the participating SwMI(s). The decision to through connect the call, delay the call or release the call is made in this state. In this state FE2 shall:

- receive call set-up responses from participating SwMI(s) and the originating SwMI and forward this information to the controlling SwMI CC application;
- when indicated by the CC application, inform the participating SwMI(s) and the originating SwMI of one of the following:
 - the call is now to be through connected;
 - the call is to be delayed;
 - the call is to be released in the specified SwMI(s);
- receive call disconnection request from the originating or participating SwMI(s) and forward this information to the controlling SwMI CC application.

From this state FE2 can go to state DELAY GROUP CALL, ACTIVE or IDLE.

6.4.2.3 DELAY GROUP CALL

This is the state used when the controlling SwMI CC application has evaluated that the call set-up is to be delayed. In this state FE2 shall:

- receive delay acceptances from the participating SwMI(s) and the originating SwMI and forward this information to the controlling SwMI CC application;
- receive call set-up responses from delaying SwMI(s) and forward this information to the controlling SwMI CC application:
 - upon call set-up acceptance from the CC application, send a call set-up to all delayed SwMI(s);
- inform indicated SwMI(s) that the call is to be released when the CC application has indicated that the call shall be released in the specified SwMI(s).

In this state FE2 may:

- receive a request from a participating SwMI or the originating SwMI that it wishes to either be release from the call or it wishes to release the complete call;

From this state FE2 can go to state GROUP CALL INITIATE or IDLE.

6.4.2.4 ACTIVE

This is the state used by the controlling SwMI ANF-ISIGC entity when the call is through connected and active. In this state FE2 shall:

- when requested by the controlling SwMI CC application:
 - poll participating SwMI(s):
 - convey polling responses from participating SwMI(s) to the controlling SwMI CC application;
 - send call information to participating SwMI(s);
 - analyse if a detaching user was the last member of the group in a participating SwMI:
 - release the call and the ANF-ISIGC connection from that participating SwMI;
 - release the call and the ANF-ISIGC connection from participating SwMI(s);

- inform SwMI(s) specified by that the CC application that the call is to be released;
- obtain routing information to the new participating SwMI (SwMIs with newly registered users) and route the call set-up information over a new inter-TETRA connection:
 - receive call set-up responses from participating SwMI and forward this information to the controlling SwMI CC application;
 - inform the participating SwMI(s) that the call is now to be through connected when indicated by the CC application;
- receive transmission and cease request from participating SwMI(s) and evaluate this information:
 - check for resource availability in participating SwMI(s);
 - inform requesting SwMI(s) of transmission grant, interrupted, ceased, queued or rejected;
 - inform participating SwMI(s) of transmission grant, interrupted or ceased;
- receive information concerning withdrawal or continuation from an active group call from participating SwMI(s) and forward this information to the controlling SwMI CC application.

In this state FE2 may:

- receive indication that an entity already active for the called group to interact with a new ANF-ISIGC (the calling user shall be merged into the call);
- receive a request from a participating SwMI that it wishes to either be release from the call or it wishes to release the complete call;
- receive information about changed call identifiers or DTMF digits from the participating SwMI(s).

From this state FE2 can go to state IDLE.

6.4.3 States at the participating SwMI

6.4.3.1 IDLE

This is the initial state for the participating SwMI ANF-ISIGC entity. In this state FE3 shall:

- receive set-up information from the controlling SwMI and forward this information to the participating SwMI CC application;
- receive from the participating SwMI CC application and forward to the controlling SwMI information that:
 - the call is ready for through connect:
 - start timer T2 as indicated in clause 6.7;
 - the call has been rejected;
 - the CC application wishes to delay the call set-up;
- release reserved resources upon expiration of timer T2;
- receive indication from the originating SwMI ANF-ISIGC entity for this call that this entity has changed status from originating to participating;
- inform the participating SwMI CC application to connect members of the group call using resources reserved by the originating SwMI ANF-ISIGC entity.

From this state FE3 can go to state WAIT CONNECTOR DELAY ENTRY.

6.4.3.2 WAIT CONNECT

This is the state where call set-up has been initiated and the participating SwMI ANF-ISIGC entity is waiting for the call to be through connected. In this state FE3 shall:

- receive indication that the call is to be through connected and forward this information to the participating SwMI CC application; or
- receive indication that the call is to be delayed and forward this information to the participating SwMI CC application; or
- receive indication that the participating SwMI CC application has accepted the delay;
- upon request from the CC application, do the following:
 - fetch and analyse the calling users profile information;
 - analyse the destination group identity (GTSI) and route the call over the existing inter-TETRA connection; or
- receive indication that this SwMI is being released from the call and forward this information to the participating SwMI CC application; or
- receive information from the participating SwMI CC application that the call is to be disconnected in the participating SwMI and forward this information to the controlling SwMI.

From this state FE3 can go to state ACTIVE, DELAY GROUP CALL, CALL DISCONNECT or CALL RELEASE.

6.4.3.3 DELAY ENTRY

This is the state used by the participating SwMI ANF-ISIGC entity when the CC application has informed the entity to delay the call set-up. In this state FE3 shall:

- receive information from the participating SwMI CC application that the SwMI is now ready for through connect and forward this information to the controlling SwMI; or
- receive indication that this SwMI is being released from the call and forward this information to the participating SwMI CC application; or
- receive information from the participating SwMI CC application that the call is to be disconnected in the participating SwMI and forward this information to the controlling SwMI.

From this state FE3 can go to state WAIT CONNECT, CALL DISCONNECT or CALL RELEASE.

6.4.3.4 DELAY GROUP CALL

This is the state where the participating SwMI ANF-ISIGC entity has been delayed during call set-up. In this state FE3 shall:

- receive indication that this SwMI is being released from the call and forward this information to the participating SwMI CC application; or
- receive information from the participating SwMI CC application that the call is to be disconnected in the participating SwMI and forward this information to the controlling SwMI; or
- upon request from the CC application, do the following:
 - fetch and analyse the calling users profile information;
 - analyse the destination group identity (GTSI) and route the call over the existing inter-TETRA connection; or

- receive set-up information from the controlling SwMI and forward this information to the participating SwMI CC application. The call is no longer delayed. As a result of the call setup continuation FE1 shall:
 - receive information from the participating SwMI CC application that the call is ready for through connect and forward this information to the controlling SwMI;
 - receive information from the participating SwMI CC application that the CC application wishes to delay the call set-up and forward this information to the controlling SwMI;
 - receive information from the participating SwMI CC application that the CC application wishes to reject the call set-up and forward this information to the controlling SwMI.

From this state FE3 can go to state WAIT CONNECT, DELAY ENTRY, CALL RELEASE or CALL DISCONNECT.

6.4.3.5 ACTIVE

This is the state used by the participating SwMI ANF-ISIGC entity when the call is through connected and active. In this state FE3 shall:

- when requested by the controlling SwMI:
 - poll members of the group call:
 - convey a polling response back to the controlling SwMI;
 - check if resources are available for transmission and reserve these resources. Forward this information to the participating SwMI CC application;
 - inform the controlling SwMI of resource reservation when requested by the participating SwMI CC application;
- receive transmission and cease request from the participating SwMI CC application and inform the controlling SwMI of transmission and cease request;
- receive transmission grant, interrupted, ceased, queued, delayed or rejected information from the controlling SwMI and forward this information to the participating SwMI CC application;
- receive information that the participating SwMI CC application wishes to either withdraw or continue with an active group call and forward this information to the controlling SwMI;
- receive call information from the controlling SwMI and forward this information to the participating SwMI CC application;
- receive indication that this SwMI is being released from the call and forward this information to the participating SwMI CC application;
- receive information from the participating SwMI CC application that the call is to be disconnected in the participating SwMI and forward this information to the controlling SwMI.

From this state FE3 can go to state CALL DISCONNECT or CALL RELEASE.

6.4.3.6 CALL DISCONNECT

The participating SwMI ANF-ISIGC entity is in this state when the CC application has made a request to be disconnected from the call. In this state FE3 shall:

- receive indication that this SwMI is being released from the call and forward this information to the participating SwMI CC application.

From this state FE3 can go to state CALL RELEASE.

6.4.3.7 CALL RELEASE

This is the state where the call is being released within a participating SwMI. This state may be used to collect call information, before the call is completely released. In this state FE3 shall:

- wait for confirmation from the participating SwMI CC application that release has been performed;
- complete the release of the ANF-ISIGC connection.

From this state FE3 can go to state IDLE.

6.5 ANF-ISIGC signalling procedures

6.5.1 General about ANF-ISIGC Signalling Procedures

The signalling procedures below specify the conditions under which the SwMI ANF-ISIGC entities send or receive the TETRA ISI PDUs defined in clause 6.3.1.

The SDL representation showing the behaviour of an ANF-ISIGC entity at the originating SwMI is shown in figures A.1 to A.4, at the group home/controlling SwMI in figures A.5 to A.10 and at the participating SwMI in figures A.11 to A.13.

6.5.2 Call set-up procedures

6.5.2.1 Forward set-up request

A group call shall be initiated by a primitive sent from the CC application to an ANF-ISIGC entity in the originating SwMI. The ANF-ISIGC entity shall evaluate the group definitions and in case the SwMI is not the group home SwMI or the SwMI is the group home SwMI but not the controlling SwMI for the set of linked groups, it shall initiate a new session towards this SwMI and including the ISI-ORIGINATING SETUP PDU defined in table 6.1.

The information element "Group attachment indicator" in the ISI-ORIGINATING SETUP PDU shall be used to indicate if the calling user is attached to the called group within the originating SwMI. According to the ANF-ISI Mobility Management standard ETSI TS 100 392-3-15 [4], the group home SwMI does not necessarily have knowledge of each group attachment made by migrated users in a visiting SwMI.

6.5.2.2 Group linking

When a forward set-up request is received and the called group is included in a set of linked groups and the group home SwMI does not coincide with the linking controlling SwMI, then the group home SwMI shall request the originating SwMI to send the ISI-ORIGINATING SETUP PDU to the linking controlling SwMI. An ISI-REROUTE PDU shall be sent from the group home SwMI to the originating SwMI and the session between the originating SwMI and the group home SwMI shall be closed. The linking controlling SwMI MNI shall be indicated in the ISI-REROUTE PDU.

When the calling user is not a member of the called group, i.e. the calling user is not attached to the called group, the information element "Group attachment indicator" shall be set to 1 in the ISI-ORIGINATING SETUP PDU sent from the originating SwMI to the linking controlling SwMI.

When groups are linked, the linking controlling SwMI has no knowledge of the individuals belonging to each group that is linked. Therefore, the originating SwMI shall inform the linking controlling SwMI whether or not the calling user is attached to the called group or not.

6.5.2.3 Call request in the (Linking) Controlling SwMI

When the call is initiated from the controlling SwMI or from another SwMI the (linking) controlling SwMI may evaluate whether the calling user shall be allowed to perform a call to the requested group based on the calling user's profile information if available and on the available group attachment information.

If the (linking) controlling SwMI grants the calling user permission to perform a call to the requested group, group call establishment shall be initiated to the participating SwMIs. The ANF-ISIGC entity should optionally first inform the originating SwMI of the call status and call set-up time used by the controlling SwMI in an ISI-INFO PDU as defined in table 6.3. The ANF-ISIGC entity shall then initiate group call set-up in the participating and the originating SwMI. A session shall be initiated towards the participating SwMIs including the ISI-SETUP INITIATE PDU defined in table 6.2. The originating SwMI shall receive the ISI-SETUP INITIATE PDU within the already established session (established at the forward setup request).

NOTE: Upon receiving the ISI-INFO PDU, the originating SwMI call control application should inform the air interface CC application of the call status and call set-up time (T302) used in the controlling SwMI.

When the calling user is not a member of the called group or the calling user is not attached to the called group in the originating SwMI and the controlling SwMI has evaluated that this user can participate in the requested group call, the information element 'temporary group member indication' shall be set to 1 in the ISI-SETUP INITIATE PDU sent to the originating SwMI. This information element indicates that the calling user shall only have permission to participate in the call, to the connected group, for the duration of the call. Once the calling user disconnects from the group call or is released from the call, a new call set-up sequence shall be performed before this user can participate in a call to the same group.

When it has been evaluated by the controlling SwMI that group profile information is needed for the calling user in the originating SwMI, the information elements 'temporary group basic migration profile' and 'SS-migration profile' shall be sent in the ISI-SETUP INITIATE PDU sent to the originating SwMI. The profiles information sent shall only contain information needed during the call maintenance phase and shall only be valid for the duration of the group call.

6.5.2.4 Call confirmation and call characteristics notification by the originating and participating SwMI(s)

Group call acceptance shall be indicated from the CC application in the originating and participating SwMI(s) to its ANF-ISIGC entity invoked for the call. This ANF-ISIGC entity in the originating and/or participating SwMI shall send the ISI-SETUP ACKNOWLEDGE PDU defined in table 6.6 within the already established session. At the same time the ANF-ISIGC entity in the originating and participating SwMI shall start timer T2. The value of this timer shall be sent to the controlling SwMI in the ISI-SETUP ACKNOWLEDGE PDU in the "Call resource time" information element.

The conditions used by the PSwMI and OSwMI to indicate to the CSwMI that they are ready to be connected into the call are implementation dependent. However, in order to provide predictable behaviour the following strategies are recommended:

- An OSwMI to send in its ISI-Setup-Acknowledge when it has resources to allow a calling party to be connected into the call. The calling party that is ready to connect is indicated in the ISI-Setup-Acknowledge. A PSwMI that becomes an OSwMI because it hosts a new calling party also follows this rule.
- A PSwMI to send back its ISI-Setup-Acknowledge as soon as it has determined that called group members exist at the PSwMI.

Upon expiration of T2 the participating/originating SwMI shall release all resources reserved for the call and request to disconnect. An ISI-DISCONNECT PDU shall be sent to the controlling SwMI.

The participating SwMI may indicate to the controlling SwMI in the ISI-SETUP ACKNOWLEDGE PDU its supported value for the sub-element 'communication type' in the information element 'basic service information' when the value received in the ISI-SETUP INITIATE PDU cannot be support (i.e. normal, acknowledge or broadcast calls). Likewise each SwMI (originating and participating) shall indicate which method of resource allocation is used (temporary or permanent). See table 6.49.

Group call delay may be indicated from the CC application in the originating SwMI or a participating SwMI to its ANF-ISIGC entity invoked for the call if the SwMI wishes to delay call set-up because it is not ready to be connected. This originating or participating ANF-ISIGC entity shall then send ISI-DELAY PDU as defined in table 6.7.

6.5.2.5 Call confirmation indication and call connected by the controlling SwMI

The controlling SwMI ANF-ISIGC entity shall send the ISI-CONNECT PDU defined in table 6.8 when it decides to connect the call having evaluated call set-up responses from SwMI(s). The conditions used by the CSwMI to connect the call are implementation specific. However to provide the most predictable behaviour the recommendation is that:

- The CSwMI connects the call when it has an OSwMI that has sent in its ISI-Setup-Acknowledge, and thus a calling party, is ready.

At the time of connection the CSwMI may send an ISI-Info PDUs indicating to delaying SwMIs that the call has been connected. The delaying SwMIs may use this information to allow any parties that are already able to join into the call to join it. The delaying SwMI does this by returning an immediate ISI-Setup-Acknowledge PDU.

Upon reception of the ISI-CONNECT PDU in the originating and participating SwMI(s), the timer T2 shall be stopped.

The ISI-Connect indicates which of the calling parties have been elected as the calling party of the call and is the party to which talk permission may be granted. The CSwMI determines which calling parties are "ready", and thus eligible to receive transmission permission, and whether the party wants to talk or not, based on the information passed to the CSwMI in the ISI-Setup-Acknowledge. An OSwMI that receives an ISI-Connect which does not indicate the calling party it indicated in its ISI-Setup-Acknowledge assumes that the calling party has been allocated to another SwMI. All of its parties are joined into the group as called parties only. There is no implied request to talk maintained by the CSwMI for parties that were calling parties of the call but were not elected by the CSwMI as the calling party of the call when it connected the call. Such parties can only be allocated talk permission after sending a new demand to talk.

If the CC application chooses to delay the group call, an ISI-RELEASE PDU as defined in table 6.21 shall be sent out to the SwMI(s) who had accepted call set-up (ISI-SETUP ACKNOWLEDGE PDU sent to the controlling SwMI). At the same time the ANF-ISIGC entity in the controlling SwMI shall start timer T1.

NOTE: The session between the peer SwMIs is **not** terminated.

Upon expiration of this timer the controlling SwMI shall release the ISI session to the delaying SwMI(s). The controlling SwMI shall then either set-up the group call between the delayed SwMI(s) or decide to release all ANF-ISIGC connections.

6.5.2.6 Delay of call set-up

Delaying SwMI(s) may request continuation of call set-up to the controlling SwMI by sending the ISI-SETUP ACKNOWLEDGE PDU as defined in table 6.6 within the established session. It is recommended that delaying SwMIs do this in accordance with the recommendations outlined in clause 6.5.2.4.

This indication shall be forwarded to the CC application of the controlling SwMI for evaluation. If call set-up already is complete the delaying SwMI shall receive an ISI-CONNECT PDU if connection was allowed by the CC application.

If the CC application indicates that the call set-up now shall continue, in accordance with the recommendation in clause 6.5.2.5, the timer T1 is stopped and call set-up shall be performed to the delayed SwMI(s). An ISI-SETUP INITIATE PDU shall be sent within the established session. The delayed SwMI(s) can then either respond positive by sending an ISI-SETUP ACKNOWLEDGE PDU or negative by sending ISI-REJECT or ask for delay with an ISI-DELAY PDU. The delayed SwMI(s) may wish to continue to delay the call. The CC application shall then again evaluate the received responses. The CC application may choose to connect the call (sending of ISI-CONNECT PDU) or delayed it again. If the call is to continue to be delayed, all SwMI(s) who had accepted the call, shall once again receive an ISI-RELEASE PDU as described in clause 6.5.2.5.

The CC application may also choose to continue the delay of the call when a delaying SwMI request for continuation of call set-up. This shall occur when other SwMI(s) have also delayed the call set-up. An ISI-RELEASE PDU shall be sent back to the delaying SwMI, this SwMI shall then become a delayed SwMI.

NOTE: The session between the peer SwMIs is **not** terminated.

6.5.2.7 Failure of call establishment

If the call attempt is rejected by the controlling SwMI (because of e.g. incompatibility of basic service information or internal congestion), an ISI-REJECT PDU as defined in table 47 shall be sent to the originating SwMI, with the appropriate reject cause and the ISI session between the peer SwMIs shall be terminated.

If the call attempt is rejected by the originating or a participating SwMI (because e.g. of internal congestion), the ISI-REJECT PDU as defined in table 6.19 shall be sent to the controlling SwMI with the appropriate reject cause and the ISI session between the peer SwMIs shall be terminated.

It should be noted that if supplementary service information is to be exchanged during call disconnection, the session termination shall be delayed until the supplementary service message sequence is complete.

6.5.2.8 Multiple calling parties

6.5.2.8.1 General about Multiple Calling parties

It is possible for a call to have multiple calling parties. It is important that no one party can prevent the call from setting up due to a lack of resources. For example, if parties on two different OSwMI call the same group at approximately the same time then there is no reason to wait to connect the call just because the first OSwMI to send in an ISI-ORIGINATING SETUP PDU to the CSwMI does not have resources to connect its calling party into the call. This issue is considered under several scenarios.

6.5.2.8.2 A new calling party appears at a SwMI not currently in the group call

In order to support a new calling party appearing when a group call is setting up, the receipt of ISI-ORIGINATING SETUP PDU, on a new ISI session, while the call is in any state is supported. The processing of the ISI-ORIGINATING SETUP PDU causes the sending back of the ISI-Setup-Initiate and the merging of the new OSwMI into the call.

6.5.2.8.3 A new, compatible, calling party appears at a SwMI where a group call is active

A new, compatible, calling party appearing in a SwMI where the call is already active should cause any signalling over the ISI interface unless this participant request for transmission. The local call instance joins the party into the call and no signalling is sent to the CSwMI.

6.5.2.8.4 A new, compatible, calling party appears at an OSwMI where a group call is still in the setup phase

Since the OSwMI will already have sent in an ISI-ORIGINATING SETUP,PDU it is recommended that another ISI-ORIGINATING SETUP PDU is not sent to the CSwMI. The sending of an ISI-ORIGINATING SETUP using the already established ISI session is acceptable, but not required.

The OSwMI attempts to get resources so that the new calling party can be connected into the call. The ISI-SETUP ACKNOWLEDGE PDU is sent to the CSwMI based on the SwMIs strategy for being ready to connect. The readiness of the new calling party should be taken in account in this situation.

The ISI-SETUP ACKNOWLEDGE sent by an OSwMI always contains the ITSI of a calling party. The CSwMI may choose this party, or another party sent in an ISI-SETUP ACKNOWLEDGE from another OSwMI, as the calling party of the call indicated in the ISI-CONNECT. The CSwMI will only physically add the calling party address into the ISI-CONNECT PDU, when the calling party is different to that sent in the ISI-SETUP INITIATE PDU. In this case the "Calling party information present" field will be set to "Calling party information is present".

6.5.2.8.5 A new, compatible, calling party appears at an PSwMI where a group call is still in the setup phase

An ISI-ORIGINATING SETUP may be sent to the CSwMI on the existing connection, the CSwMI does not send a response PDU. The PSwMI now changes its designation to an OSwMI and proceeds as described in the clause above. The strategy it uses for sending back its ISI-SETUP ACKNOWLEDGE PDU is changed from the one appropriate for a PSwMI to the one appropriate for an OSwMI.

The ISI-ORIGINATING SETUP PDU may also be sent in a new ISI session.

On receipt of the ISI-ORIGINATING SETUP PDU, the CSwMI reclassifies the old PSwMI as a new OSwMI.

6.5.2.8.6 A new calling party requesting an emergency call appears at a SwMI where the existing call is not at an emergency priority

If an emergency priority call request is received, for a group that is already known to be in a group call at a non-emergency priority, then a new ISI session is used to send an ISI-ORIGINATING SETUP PDU to the CSwMI. The CSwMI disconnects the existing call and sets up the new emergency call to the same group.

The SwMI of the new calling party may choose to release the existing call, prior to being told to do so by the CSwMI.

6.5.2.8.7 A new, non-compatible, calling party appears at a SwMI where a group call is already active

If a SwMI decides that a new calling party is not compatible with an existing group call then the SwMI will not join the new party into the call. No ISI signalling is involved in this case.

The decision as to what is, and what is not a compatible call is a SwMI dependent matter, reasons could be:

- The new calling party is not a member of the group.
- Incompatible priority (below emergency).
- Data call requested.
- Incompatible SS-Facility.
- Resources not available.
- Others.

Once a SwMI has accepted a new calling party as able to call the group then no other SwMI may reverse that decision.

6.5.2.8.8 A new calling party appears at a CSwMI that only supports a single ISI-ORIGINATING SETUP PDU

A CSwMI receiving a further ISI-ORIGINATING SETUP when it does not support more than one may reject, with an ISI-Reject, the additional call request.

6.5.2.8.9 The sending of subsequent ISI-ORIGINATING SETUP PDUs to the CSwMI

When it is possible to send another ISI-ORIGINATING SETUP PDU to the CSwMI this can be done in one of two ways:

- The ISI-ORIGINATING SETUP PDU may be sent in the existing ISI session for the call. In this case the CSwMI will not respond to the ISI-ORIGINATING SETUP. In order to achieve this the sending SwMI will already have locally merged the new calling party into the existing call.
- The ISI-ORIGINATING SETUP PDU may be sent in a new ISI session establishment request, to the CSwMI. In this case the CSwMI will respond, within the same session, with an ISI-SETUP INITIATE PDU. Since the call setup is already ongoing between the CSwMI and the nominated SwMI using another ISI session, the CSwMI will set the "call amalgamation" information element to "Call has been amalgamated" in the ISI-SETUP INITIATE PDU. The SwMI receiving the ISI-SETUP INITIATE PDU will merge the call with the existing call to the same group that it already has running. The older ISI session will be used for the merged call. It is the responsibility of the CSwMI to clear down the new ISI session. This is done by sending the ISI-SETUP INITIATE PDU in a session releasing message.

NOTE: The only mandatory uses of a subsequent ISI-ORIGINATING SETUP PDU are when a PSwMI turns into an OSwMI during call setup, and when an emergency call is started in a SwMI already having a call to the same group at a non-emergency priority. It is recommended that these are the only times a subsequent ISI-ORIGINATING SETUP PDU is used.

6.5.2.9 Security level

The "Security level at air interface" information element in ISI-ORIGINATING SETUP PDU, ISI-SETUP INITIATE PDU, ISI-SETUP ACKNOWLEDGE PDU and ISI-CONNECT PDU shall be used as follows:

- OSwMI informs the current (default) security level of the group at air interface in ISI-ORIGINATING SETUP PDU to CSwMI.
- CSwMI informs the security level that is recommended to be used in all SwMIs for the group call at air interface in ISI-Setup-Initiate to OSwMI and PSwMI.
- OSwMI and PSwMI inform the same security level that was recommended to be used in all SwMIs for the group call in ISI-SETUP-ACKNOWLEDGE PDU to CSwMI. However, if the nominated SwMI is not able to follow the recommendation, the OSwMI/PSwMI shall indicate the security level it is capable for the group.
- CSwMI then informs the security level that shall be used in the OSwMI and PSwMIs for the group call in ISI-Connect PDU and all the SwMIs shall follow it. The CSwMI may downgrade the security level to clear if some SwMI does not support air interface encryption for the group or CSwMI may leave the SwMIs out of the call if in those SwMIs the security level in the air interface is not sufficient.

6.5.3 Acknowledge group call

The controlling SwMI may poll group members after call set-up, by sending an ISI-POLL USER PDU (see table 6.9) to participating SwMI(s) as described in stage 1, clause 4.2.2.3.6. This PDU shall be sent within the existing ISI session. Participating SwMI(s) shall poll group members when requested by the controlling SwMI and return the requested polling response to the controlling SwMI in an ISI-POLL RESPONSE PDU sent within the established ISI session.

The controlling SwMI may inform the participating SwMI(s) of the poll result by using an ISI-INFO PDU as defined in table 6.4. This PDU shall also be sent within the existing ISI session.

6.5.4 Call maintenance procedures

6.5.4.1 General about Call maintenance procedures

No ISI hang timer exists for releasing the ISI session between the controlling and participating SwMI(s). The ISI session shall be permanently available for the duration of the call. The ISI session shall only be release when the controlling SwMI or a participating SwMI initiates a full or partial group call release.

6.5.4.2 Transmission control procedures

Transmission Request

When a transmission request is received in a participating SwMI, this request shall be forwarded to the controlling SwMI ANF-ISIGC entity in an ISI-TX DEMAND PDU as defined in table 6.11. This PDU shall be sent within the existing ISI session. Depending on the result of the received request (see clause 4.2.2.3.8) in the controlling SwMI, the following actions shall be taken.

Transmission Not Granted/Queued

When a transmission request cannot be granted immediately - the request is either queued or rejected - the ISI-TX GRANTED as defined in table 6.15, shall be sent to the requesting SwMI with the appropriate transmission not granted cause (not granted or queued).

Transmission Interrupt

If another transmission is ongoing and the requesting user is allowed to interrupt the transmission, an ISI-TX INTERRUPT PDU, as defined in table 6.16, shall be sent to both the requesting SwMI and to all other participating SwMIs when transmission is granted.

Transmission Granted

If transmission is to be granted to the requesting user and no other transmission is active, resource allocation shall be performed in SwMI(s) with temporary allocated resources and new SwMIs may be included in the call (PTT initiated Late Entry).

NOTE 1: The Late Entry procedure denotes a normal call establishment initiated from the controlling SwMI as described in clause 6.5.2. The CSwMI may decide either to wait or not to wait for the new SwMI to be able to join the call before granting the transmission permission. The procedure will not be elaborated further in this clause.

An ISI-RESOURCE PDU (table 6.12) shall be sent to the participating SwMI(s) supporting temporary resource allocation within the existing ISI session. If the SwMI could reserve resources for the new transmission, then this SwMI shall indicate so in the ISI-RESOURCE RESPONSE PDU within the existing ISI session. Otherwise an indication that resources could not be reserved, shall be sent in the same PDU. Together with the resources not reserved indication, a participating SwMI may request the controlling SwMI to delay transmission granting if it is known by the participating SwMI that resources will be available within a short period of time. When all resource information is available the controlling SwMI CC application shall evaluate if transmission is to be granted, delayed or rejected. The ISI-TX GRANTED PDU, as defined in table 6.15, shall be sent to both the requesting SwMI and to all other participating SwMIs if transmission is granted.

NOTE 2: For all participating SwMI with permanent resource allocation, it is expected that the relevant resources are available throughout the call.

If the controlling SwMI decides to delay the transmission, all participating SwMIs supporting temporary resource allocation shall receive the information that the resources can be released without releasing the ISI session to them, i.e. this is the same procedure as delay during call set-up. Each participating SwMI with temporary allocation of resources shall receive an ISI-TX CEASED PDU to enable them to free up the resources they had just reserved. The information element 'transmission ceased' in the ISI-TX CEASED PDU shall be set to "Delay transmission request". The participating SwMI where the requesting user is located should not inform the requesting user of transmission delay.

NOTE 3: Only participating SwMI(s) with temporary allocation of resources will be informed of the transmission delay.

Upon reception of the ISI-TX CEASED PDU with a delay indication, each participating SwMI is allowed release all resources reserved during the ISI-RESOURCE/ISI RESOURCE RESPONSE sequence. The participating SwMI should return to the same state as just before the ISI-RESOURCE/ISI RESOURCE RESPONSE sequence.

The ANF-ISIGC entity in the controlling SwMI shall initiate the T3 timer when transmission delay is to occur. The timer is used to either:

- initiation of call release to all active SwMIs, if no response is received from the delaying SwMI within a certain period of time;
- grant transmission to the requesting user after a new set of resource reservation sequences has been performed and new participating SwMI(s) have been set-up in the call; or
- grant transmission permission to another user. In this case, call set-up to the new participating SwMI(s) and resource reservation sequences will be performed again.

When the delaying SwMI has the necessary resources available to perform the transmission, the delaying SwMI shall send the ISI-RESOURCE RESPONSE again. The 'Resource indicator' information element shall now be set to 'Resources are reserved'.

NOTE 4: If the delaying SwMI determines that resources could not be acquired before time out of T3, the SwMI may send the ISI-RESOURCE RESPONSE PDU with the 'Resource indicator' information element set to 'Resources could not be reserved'. The controlling SwMI will then stop T3, remove the transmission request and may grant transmission to any other requesting user.

Upon reception of the ISI-RESOURCE RESPONSE PDU with 'Resources are reserved' indication from the delaying SwMI, the controlling SwMI shall send a ISI-RESOURCE PDU to each participating SwMI with temporary allocated resources to reserve resources for transmission once again.

Transmission Ceased

When a cease of transmission request is received in a participating SwMI, this request shall be forwarded to the controlling SwMI ANF-ISIGC entity in an ISI-TX CEASED PDU as defined in table 6.14. This PDU shall be sent within the existing ISI session. Depending on the result of the received request (current transmission is ceased or a queued transmission request has been granted permission to transmit) in the controlling SwMI, the participating SwMIs may be informed and may either receive an ISI-TX CEASED PDU as defined in table 6.14 or an ISI-TX GRANTED PDU. If a queued transmission request has been removed from the transmission queue due to the ISI-TX CEASED, then no response to the ISI-TX CEASED PDU shall be sent from the controlling SwMI to the requesting SwMI and no information is sent to other SwMIs.

Transmission Wait/Continue

When a participating SwMI wishes to withdraw from an active group call or rejoin an active group call, an ISI-TX WAIT PDU as defined in table 6.18 or an ISI-TX CONTINUE PDU shall be sent to the controlling SwMI. The PDU shall be sent within the existing ISI session.

Throttling of Demands

It is recommended that a CSwMI limits the number of transmit demands which it queues. To avoid unnecessary loading on the CSwMI it is also recommended that a PSwMI limit the number of simultaneous demands that it has outstanding with the CSwMI. Any demand that cannot be passed to the CSwMI can be rejected back to the demanding party.

6.5.4.3 Call modification and/or continuation

The controlling SwMI may wish to inform the participating SwMI(s) a change in the call time-out time. When requested by the CC application of the controlling SwMI, the ANF-ISIGC entity shall send an ISI-INFO PDU to the participating SwMI(s) as defined in table 6.3.

The same PDU may also be used to request call modification in the participating SwMI(s) (as specified in clause 14.5.2.2 of ETSI EN 300 392-2 [1]).

If the received modifications cannot be accepted by the SwMI, an ISI-DISCONNECT PDU as defined in table 6.20 shall be returned to the controlling SwMI.

6.5.4.4 DTMF procedures

The DTMF information shall be sent over the ISI in the ISI-INFO PDU defined in table 6.5.

6.5.5 Call disconnection procedures

When the originating SwMI or a participating SwMI wishes to be disconnected from the group call, an ISI-DISCONNECT PDU shall be sent to the controlling SwMI. This information is forwarded to the CC application in the controlling SwMI for evaluation.

NOTE 1: The originating SwMI may wish to be released from the call after sending the ISI-SETUP ACKNOWLEDGE PDU but before the ISI-CONNECT PDU is received.

The CSwMI CC application may choose to release the requesting SwMI or release the complete call. If only the release requesting SwMI is to be released, an ISI-RELEASE PDU shall be sent to this SwMI.

NOTE 2: When the disconnection request has been sent from the call owner, the complete call is always released (the information element 'call owner request' has been set in the ISI-DISCONNECT PDU).

If the complete call is to be released, an ISI-RELEASE PDU shall be sent out to all SwMI(s) participating in the group call.

When the group call is released upon request from the CC application in the controlling SwMI, the same procedures as described for complete call release above shall be performed.

If a calling party leaves the call during the call establishment phase, and that party is not the only calling party on the OSwMI, then the OSwMI may optionally send in an ISI-DISCONNECT PDU with an Air Interface specific 'Disconnect cause'. The CSwMI CC determines based on the 'Disconnect cause' if the OSwMI shall remain in the call or shall be removed from the call.

If a disconnecting SwMI knows that the call is to be cleared in the disconnecting SwMI, then it can initiate the clearing before sending the ISI-DISCONNECT PDU with an ISI specific 'Disconnect cause' to the CSwMI. An ISI-RELEASE PDU will be sent from the CSwMI to the requesting SwMI.

The CSwMI may release the call at any time. After the call is active, PSwMIs may disconnect when there are no longer any active parties on the SwMI.

It should be noted that if supplementary service information is to be exchanged during call disconnection, the termination of the ISI session shall be delayed until the supplementary service message sequence is complete.

6.6 Protocol interaction between ANF-ISIGC and supplementary services and other ANFs

6.6.1 Call Forwarding Unconditional (SS-CFU)

ANF-ISIGC shall interact with SS-CFU when a group call is forwarded to a group located in a SwMI other than the called group's home SwMI.

When the called group's home SwMI does not coincide with the forwarded to group's home SwMI, then an ISI-REROUTE PDU as defined in table 6.22 shall be sent to the originating SwMI. The ISI session shall be terminated. To re-route the call, the ANF-ISIGC entity in the originating SwMI shall initiate a new call establishment, using the group home SwMI MNI received in the ISI-REROUTE PDU.

NOTE 1: If the calling user and the called group have the same home SwMI and the calling user has not migrated, the call will be an intra-TETRA call. In such cases, if SS-CFU is activated for the called group and if the forwarded-to group is registered in a different SwMI, SS-CFU will invoke an ANF-ISIGC for the establishment of the call.

NOTE 2: When SS-CFU is invoked for a call, i.e. for a group, the SS-CFU notification information is transported transparently between group home SwMI(s) or between the group home SwMI and the originating SwMI.

6.6.2 Call Authorized by Dispatcher (SS-CAD)

When SS-CAD is invoked for an incoming group call and the operation of SS-CAD entails the establishment of a call between the calling user and the dispatcher (i.e. diversion to the dispatcher) and the calling user is located in a SwMI other than the restricted groups home SwMI, a group call set-up shall be made between the calling user in the originating SwMI and the dispatcher. (See clause 6.5.2 for call set-up.) When sending the ISI-SETUP INITIATE PDU to the originating SwMI, the information element 'Call diverted to dispatcher' shall be set. This information element shall be used to indicate to the originating SwMI that SS-CAD has been invoked by the group home SwMI for the called group and direct set-up shall be made to the dispatcher.

NOTE 1: This caters for the case where the originating SwMI does not support SS-CAD.

Upon reception of the TETRA PDU ISI-CONNECT (defined in table 6.8), the originating SwMI shall however, remain to exist. The originating SwMI shall not change status to a participating SwMI and any called group members located in the SwMI shall not be connected.

The originating SwMI shall only upon reception of the TETRA PDU ISI-THROUGH CONNECT (defined in table B.1 in annex B) sent from the controlling SwMI change status to a participating SwMI and connect any called group members located in the SwMI. At this point the originating SwMI shall cease to exist. Even though the originating SwMI does not support SS-CAD, the TETRA PDU ISI-THROUGH CONNECT shall be supported.

When the dispatcher is located in a SwMI other than the restricted groups home SwMI in the case above, call set-up to this dispatcher shall be performed as described in ETSI EN 300 392-11-6 [6].

NOTE 2: When the calling user is located in the restricted groups home SwMI and the dispatcher is located in another SwMI, SS-CAD will invoke ANF-ISIIC to the dispatcher as described in ETSI TS 100 392-3-12 [3].

When the operation of SS-CAD does not entail the establishment of a call between the calling user and the dispatcher (i.e. interception by the dispatcher), only the transport connection shall be through connected. This connection shall be used to inform the calling user of acceptance or rejection by the dispatcher or of a possible diversion to the dispatcher. The TETRA call set-up shall continue depending upon the received response.

NOTE 3: See annex B for information flow diagrams describing the interaction between ANF-ISIGC and SS-CAC.

6.6.3 Area Selection (SS-AS) and selected area number

The information element "selected area number" shall be carried in the TETRA ISI-ORIGINATING SETUP PDU. The "selected area number" information element carries the same information as the "area selection" in the air interface, but adapted to the ISI signalling. The information element shall be used by the group/linking home SwMI during call set-up, in the cases of late entry.

6.6.4 Priority Call (SS-PC)

If SS-PC has been activated and call set-up operates by queuing, then each group call shall be established according to the queuing mechanism implemented in the SwMI(s) for priority.

The calling user shall send the call priority level to the controlling SwMI in the ISI-ORIGINATING SETUP PDU when the calling user is not located in the called group's home SwMI. The controlling SwMI may then accept this priority level or change it. The priority level given for the call shall be sent in the ISI-SETUP INITIATE PDU.

6.6.5 Pre-emptive Priority Call (SS-PPC)

SS-PPC shall interact with ANF-ISIGC to pre-empt an inter-TETRA connection with the lowest CRV among those which may be used to route the priority call. SS-PPC shall invoke pre-emption by forcing the clearing of the chosen inter-TETRA connection. An ISI-RELEASE PDU shall be sent out to participating SwMI(s) being released from the group call (see clause 6.5.5 for complete release of a group call). The controlling SwMI shall then invoke a new ANF-ISIGC at the corresponding ISI by sending an ISI-SETUP INITIATE PDU (see clause 6.5.2 for call set-up sequence).

NOTE 1: The correct time to tear down the inter-TETRA connections and allocate new inter-TETRA connections, should be when the controlling SwMI has received positive indication back from the participating SwMI that it can and will support the group call (ISI-SETUP ACKNOWLEDGE PDU sent from the participating SwMI(s)).

NOTE 2: When a call extends between several TETRA systems, different call retention values may be used for resources allocated within each system. SwMIs should therefore, give its own resources lower call retention values than resources owned by other SwMIs. This then insures that a SwMI will always pre-empt its own resources.

6.6.6 Include Call (SS-IC)

When the group call owner wishes to include a user or group of users who are not members of the active group call and who are registered in a SwMI other than the controlling SwMI, call set-up shall be initiated by sending an ISI-SETUP INITIATE PDU as defined in table 6.2 from the controlling SwMI ANF-ISIGC entity.

NOTE: The controlling SwMI approves always the inclusion of a user or group of users before call set-up is initiated towards the specified user(s).

Group call acceptance shall be indicated from the CC application in the new participating SwMI(s) to its ANF-ISIGC entity invoked for the call. This ANF-ISIGC entity shall send a ISI-SETUP ACKNOWLEDGE PDU.

The controlling SwMI ANF-ISIGC entity shall then send the ISI-CONNECT PDU defined in table 6.8 when call set-up responses from the participating SwMI(s) have been evaluated by the CC application in the controlling SwMI and call confirmation has been indicated.

See clauses 6.5.2.4 to 6.5.2.7 for a complete description of call set-up procedures.

6.6.7 Call Retention (SS-CRT)

The CRV is dynamically assigned by a SwMI, to inter-TETRA connection used to route the group call. This value may differ in SwMIs using the same inter-TETRA connection for the group call. The CRV is only known locally within the SwMIs.

6.6.8 Interactions with other supplementary services

At the time the present document was written, no other supplementary service has been identified which could require for its invocation or its operation of an interaction with ANF-ISIGC.

NOTE: Such supplementary services require only the transport of their PDUs (i.e. SS PDUs) through ANF-ISISS, as defined in clauses 9 and 10 of ETSI EN 300 392-9 [i.1].

6.7 ANF-ISIGC parameter values (timers)

ANF-ISIGC shall use timer T1 as defined in clauses 6.5.2.5 and 6.5.2.6 when a group call is delayed. The timer is used to release ISI channel resources and delaying SwMI(s), if no response is received from the delaying SwMI within a certain period of time. The value of this timer shall be 30 s.

ANF-ISIGC shall use timer T2 as defined in clauses 6.5.2.4 and 6.5.2.5 when an ISI-SETUP ACKNOWLEDGE PDU is sent from the originating or participating SwMI(s). The timer is used to release air interface and infrastructure resources if no ISI-CONNECT PDU is received from the controlling within a certain period of time. The minimum value of this timer shall be 5 s, and its maximum value, 30 s.

ANF-ISIGC shall use timer T3 as defined in clauses 6.5.4.2 when a transmission request is delayed. The timer is used to either continue transmission handling or to release the group call, when no response is received from the delaying SwMI within a certain period of time. The minimum value of this timer shall be 5 s, and its maximum value, 15 s.

The ISI session shall be permanently available for the duration of the call. Therefore, no ISI hang timer exists for releasing the ISI session between the controlling and participating SwMI(s).

Annex A (normative): Specification and Description Language (SDL) representation of procedures

A.1 General

The diagrams in this annex use the Specification and Description Language defined in Recommendation ITU-T Z.100 [i.2].

The diagrams represent the behaviour of ANF-ISIGC entities within each SwMI participating in a group call.

At a SwMI, an output symbol represents a primitive. The output primitive results from an ANF-ISIGC PDU being received. The output primitive bears the name of the received ANF-ISIGC PDU.

A.2 SDL representation of an ANF-ISIGC entity at FE1

Figures A.1 to A.3 show the behaviour of an ANF-ISIGC entity at the originating SwMI.

The following conventions are used:

- the input signals from the left represent primitives from the originating SwMI call control application;
- the output signals to the left represent primitives to the originating SwMI call control application;
- the input signals from the right represent PDUs from the group home/controlling SwMI ANF-ISIGC entity;
- the output signals to the right represent PDUs to the group home/controlling SwMI ANF-ISIGC entity.

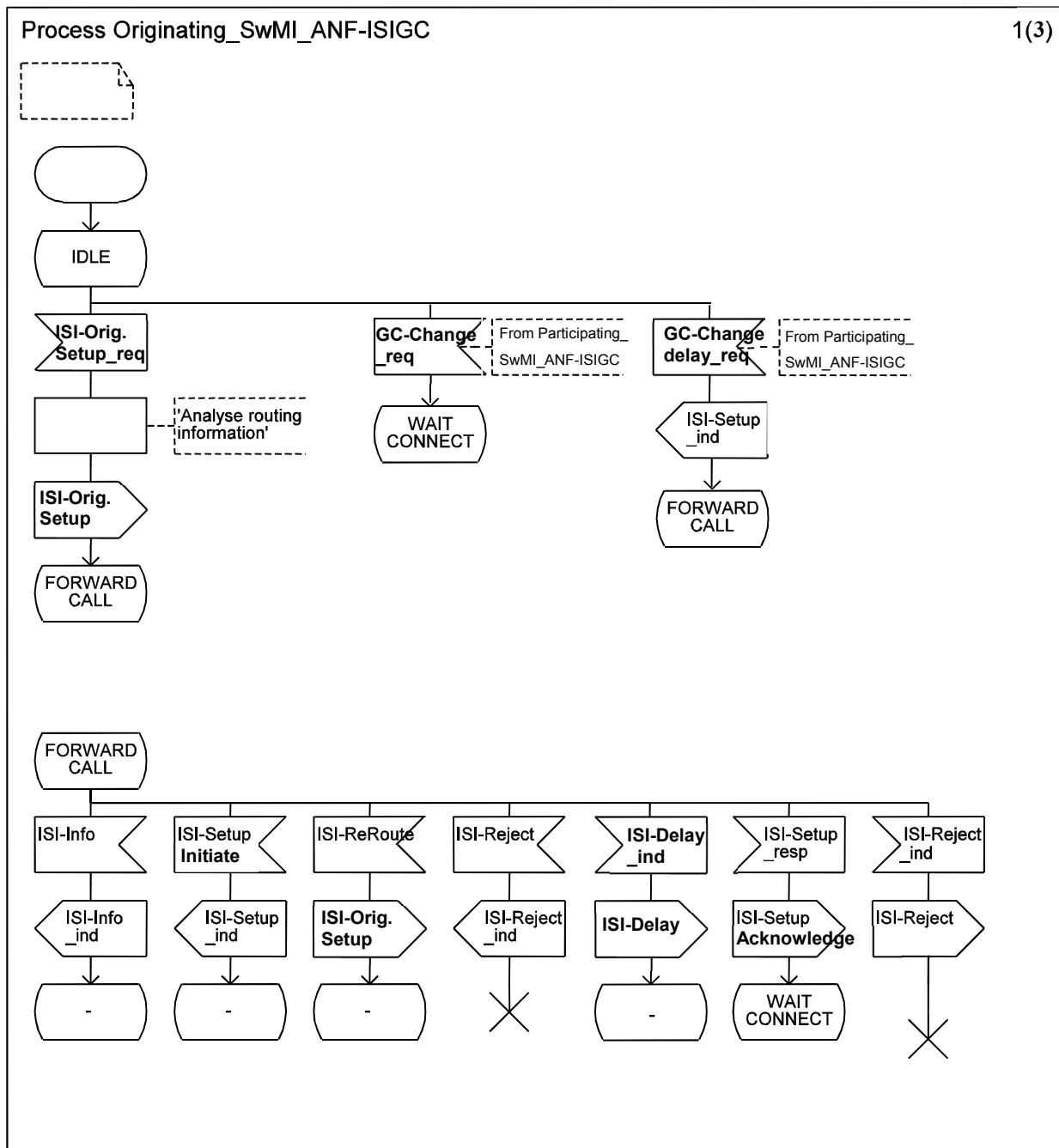

Figure A.1: SDL for originating SwMI ANF-ISIGC entity

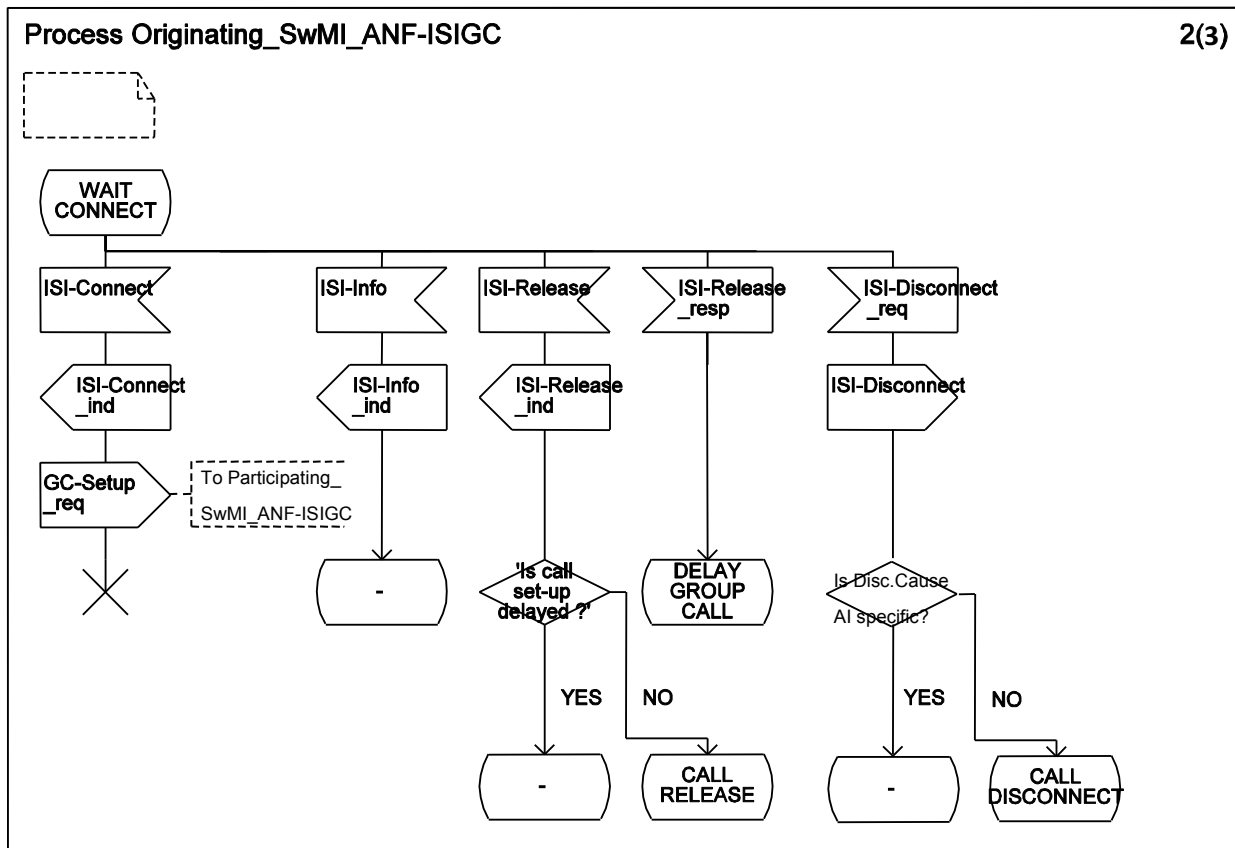

Figure A.2: SDL for originating SwMI ANF-ISIGC entity

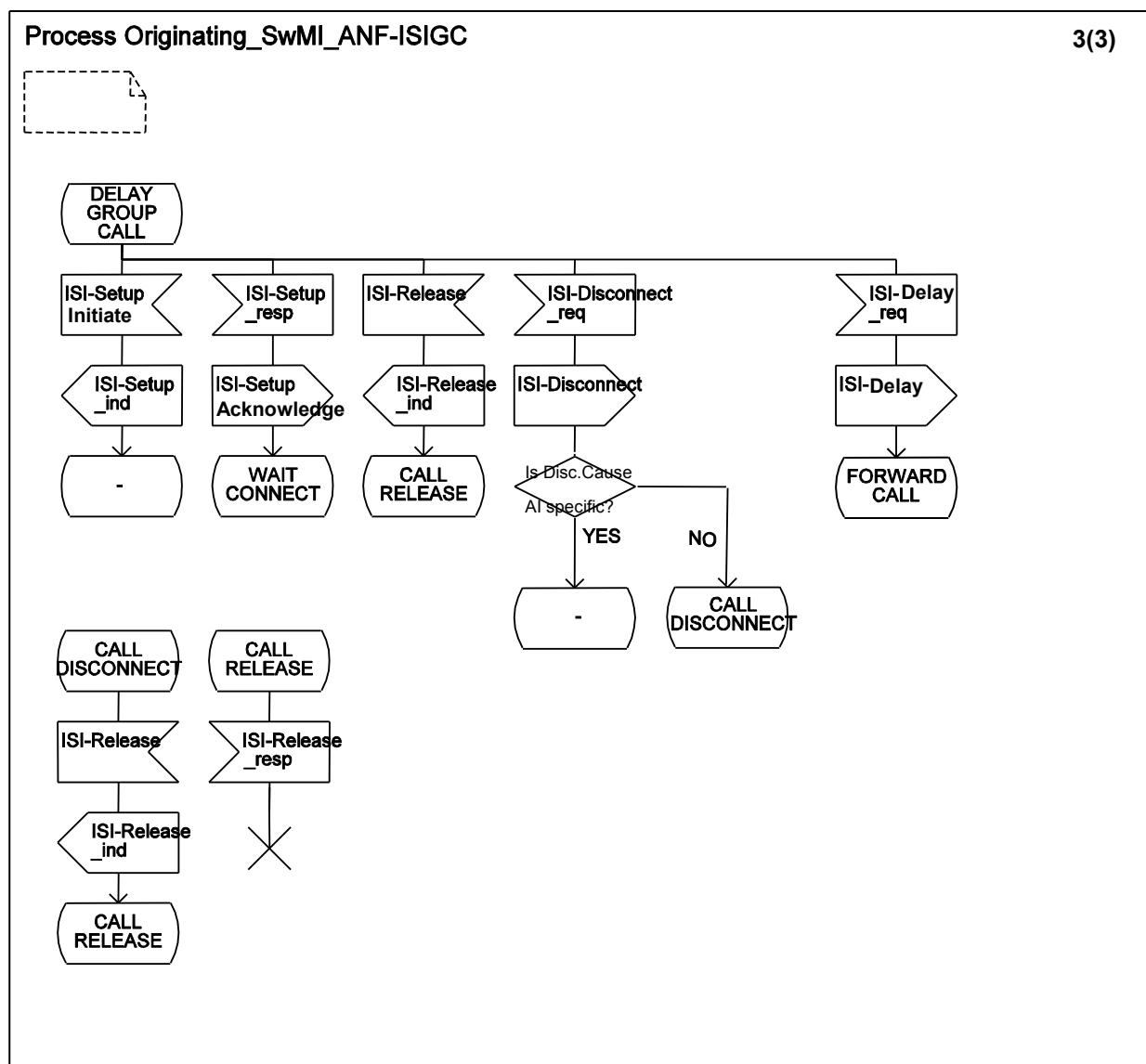

Figure A.3: SDL for originating SwMI ANF-ISIGC entity

A.3 SDL representation of an ANF-ISIGC entity at FE2

Figures A.4 to A.7 show the behaviour of an ANF-ISIGC entity at the group home/controlling SwMI.

The following conventions are used:

- the input signals from the left represent primitives from the group home/controlling SwMI call control application;
- the output signals to the left represent primitives to the group home/controlling SwMI call control application;
- the input signals from the right represent primitives from the originating or participating SwMI ANF-ISIGC entity;
- the output signals to the right represent primitives to the originating or participating SwMI ANF-ISIGC entity.

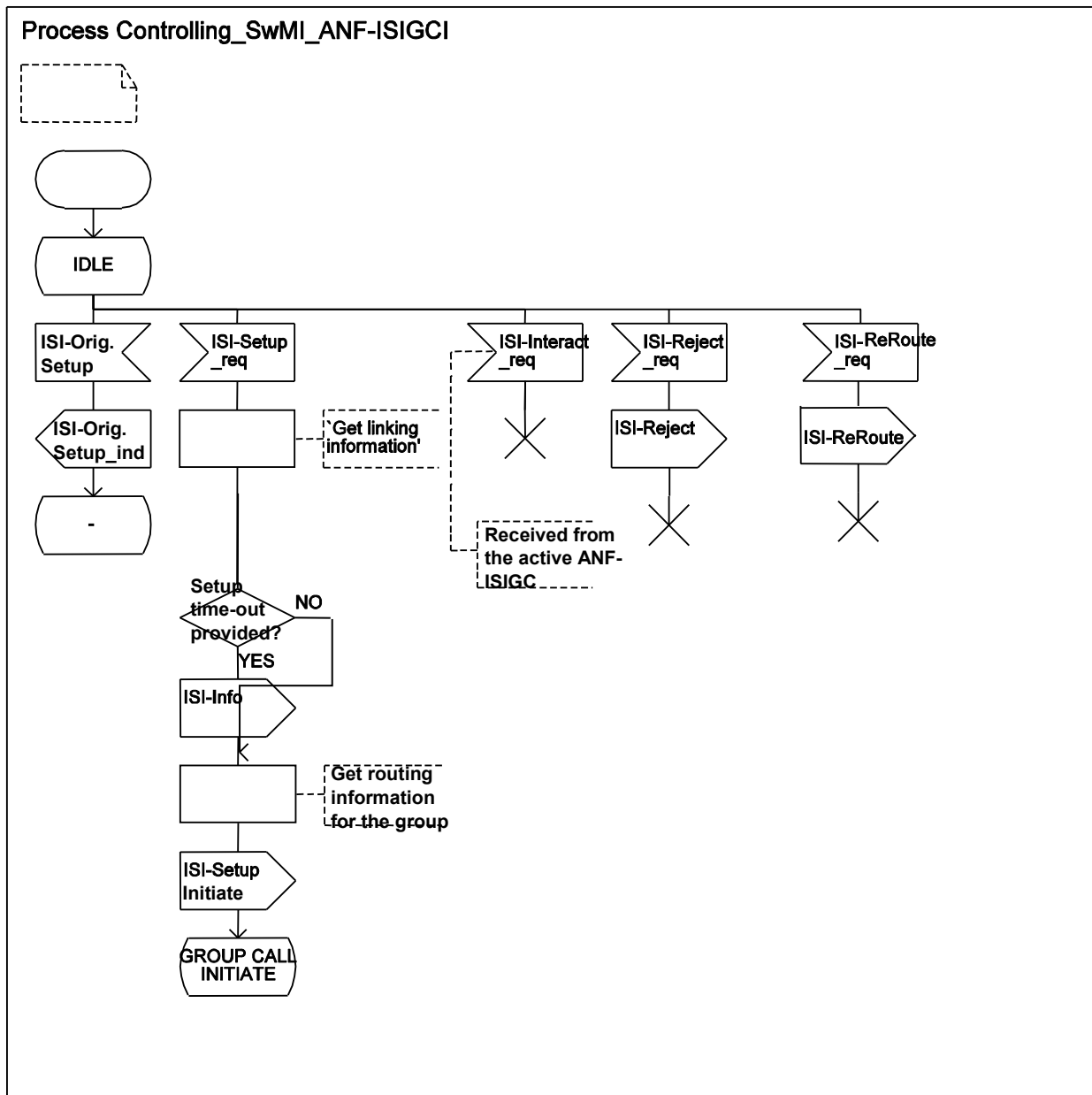

Figure A.4: SDL for group home/controlling SwMI ANF-ISIGCI entity

Process Controlling_SwMI_ANF-ISIGCI

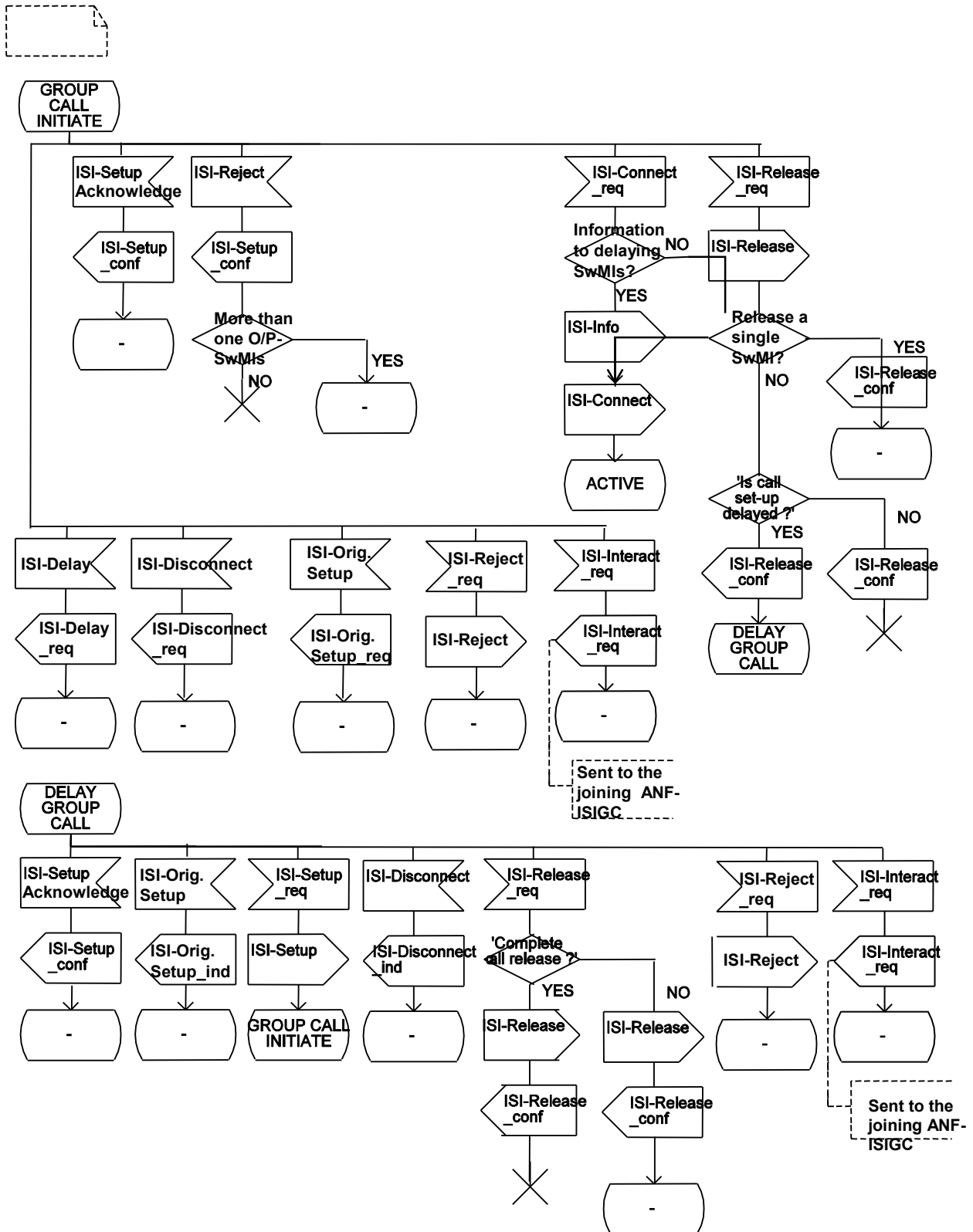

Figure A.5: SDL for group home/controlling SwMI ANF-ISIGCI entity

Process Controlling_SwMI_ANF-ISIGCI

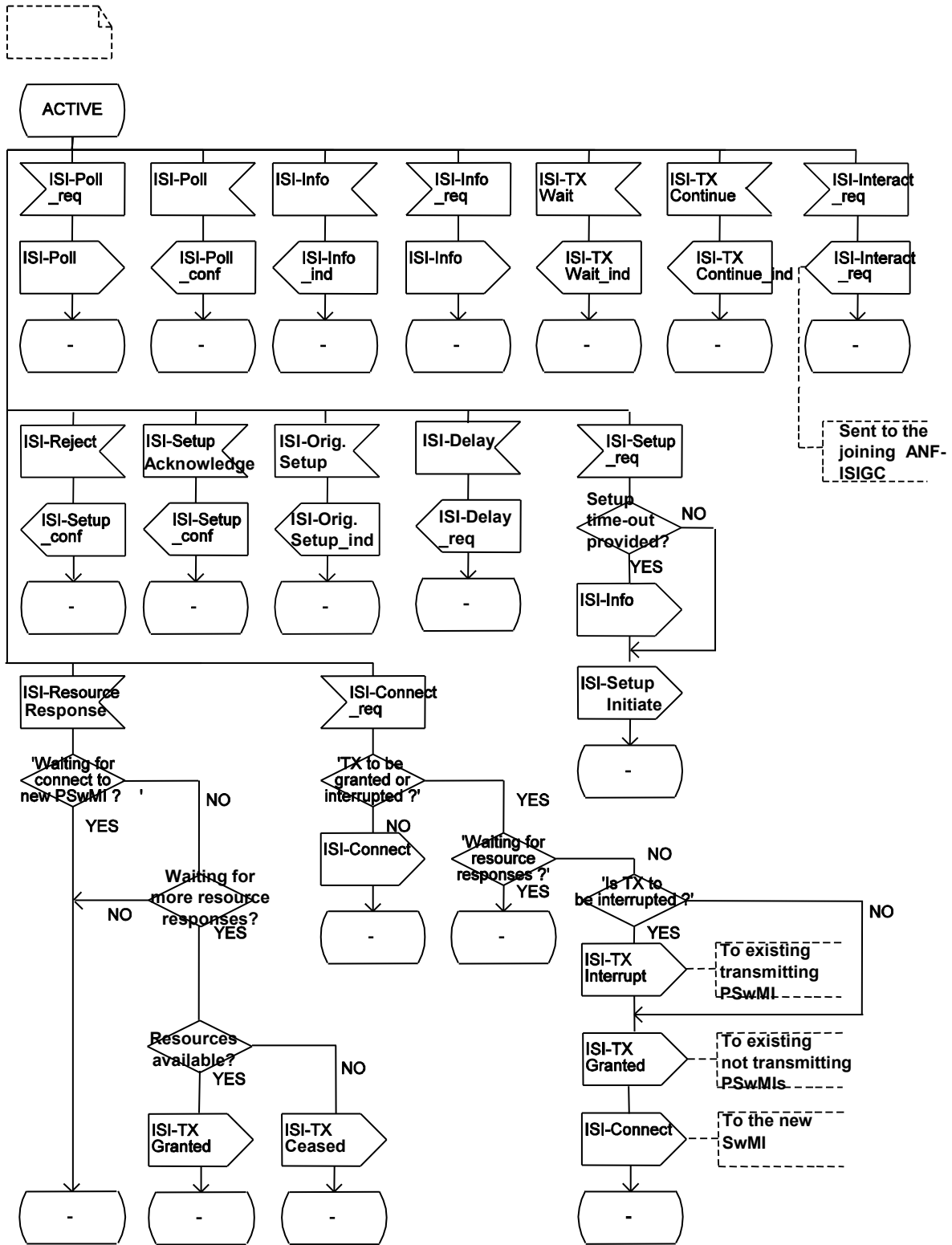

Figure A.6: SDL for group home/controlling SwMI ANF-ISIGC entity

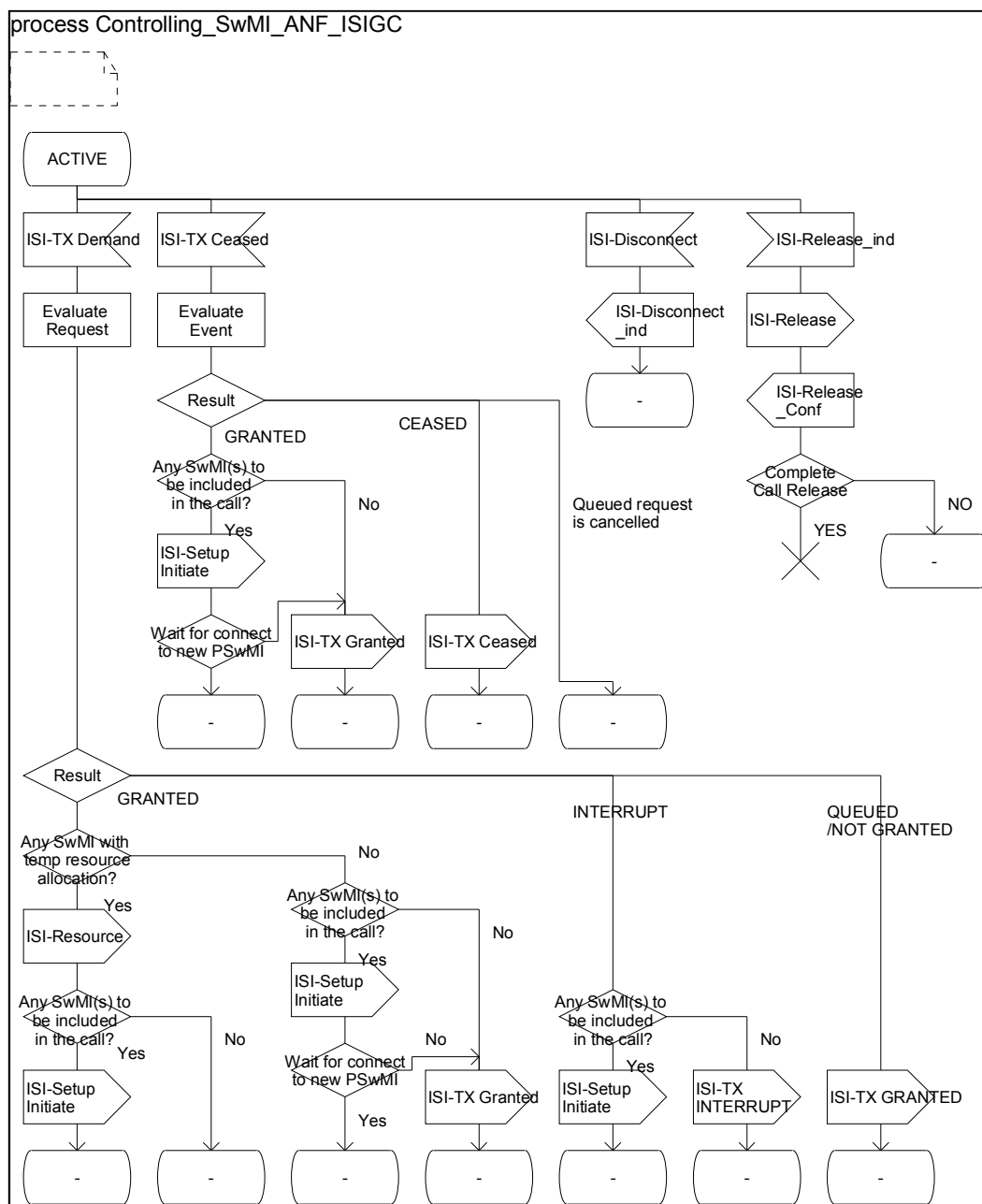

Figure A.7: SDL for group home/controlling SwMI ANF-ISIGC entity

A.4 SDL representation of an ANF-ISIGC entity at FE3

Figures A.8 to A.10 show the behaviour of an ANF-ISIGC entity at the participating SwMI.

The following conventions are used:

- the input signals from the left represent primitives from the participating SwMI call control application;
- the output signals to the left represent primitives to the participating SwMI call control application;
- the input signals from the right represent primitives from the controlling SwMI ANF-ISIGC entity;
- the output signals to the right represent primitives to the controlling SwMI ANF-ISIGC entity.

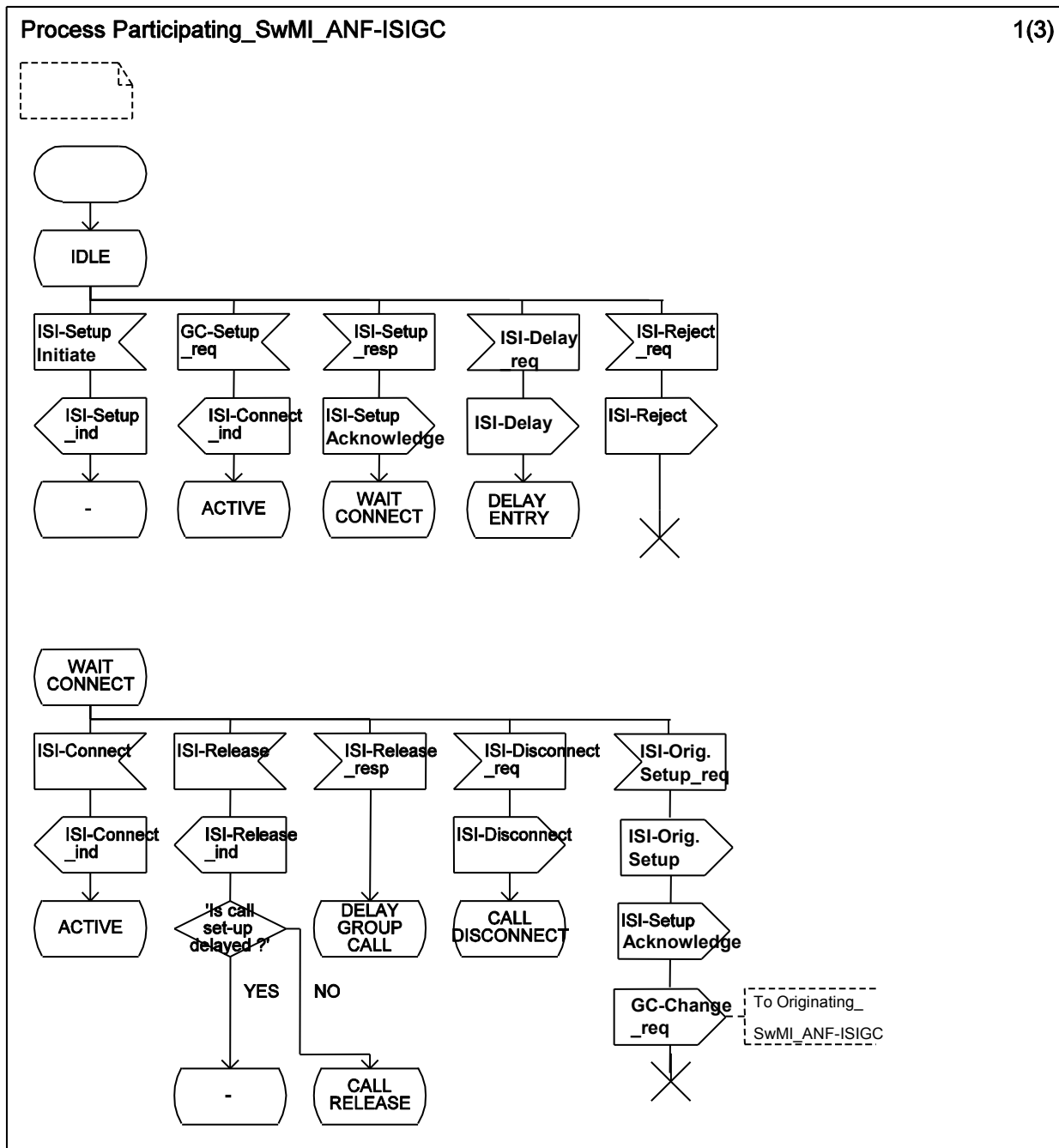

Figure A.8: SDL for participating SwMI ANF-ISIGC entity

Process Participating_SwMI_ANF-ISIGC

2(3)

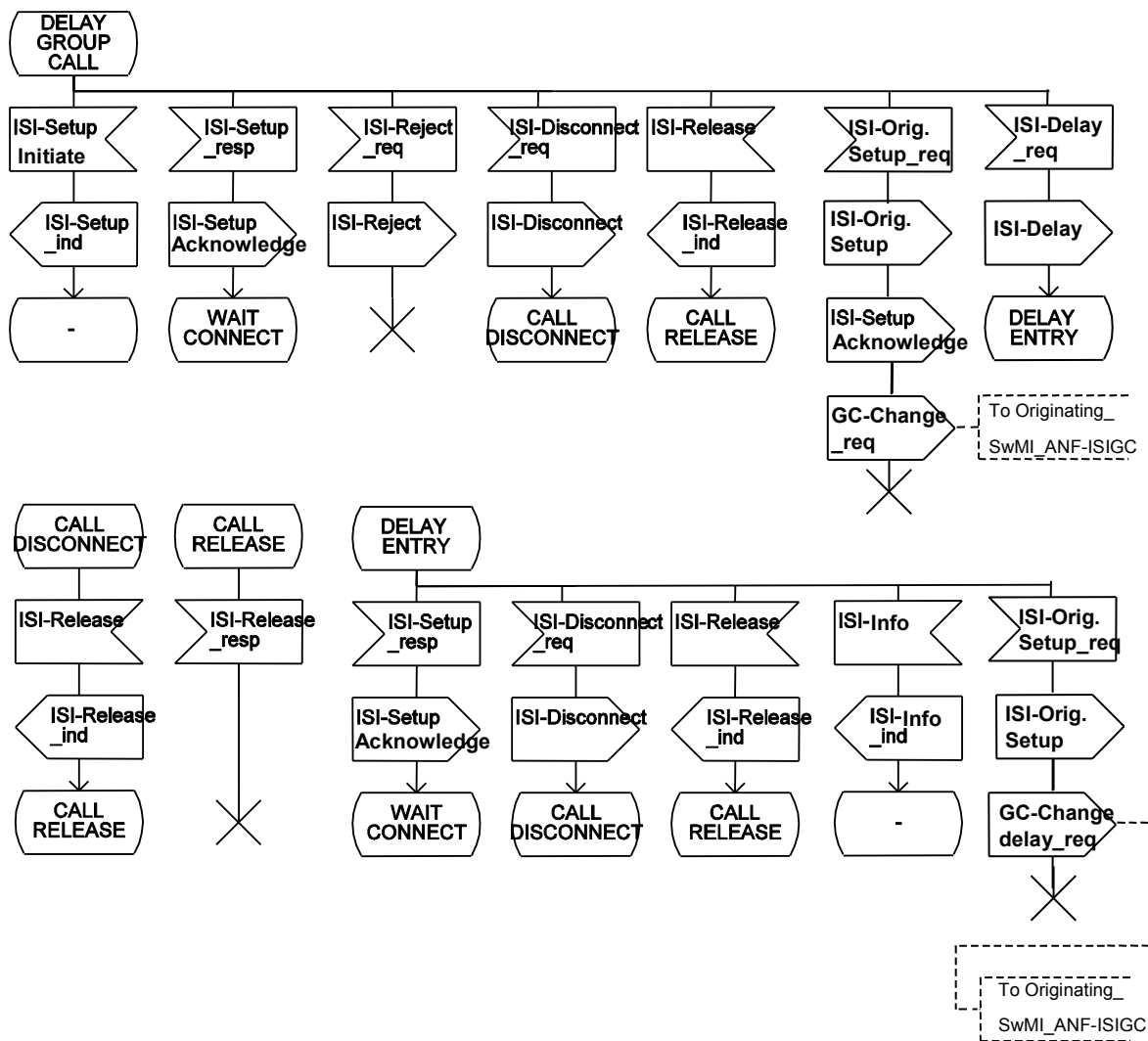

Figure A.9: SDL for participating SwMI ANF-ISIGC entity

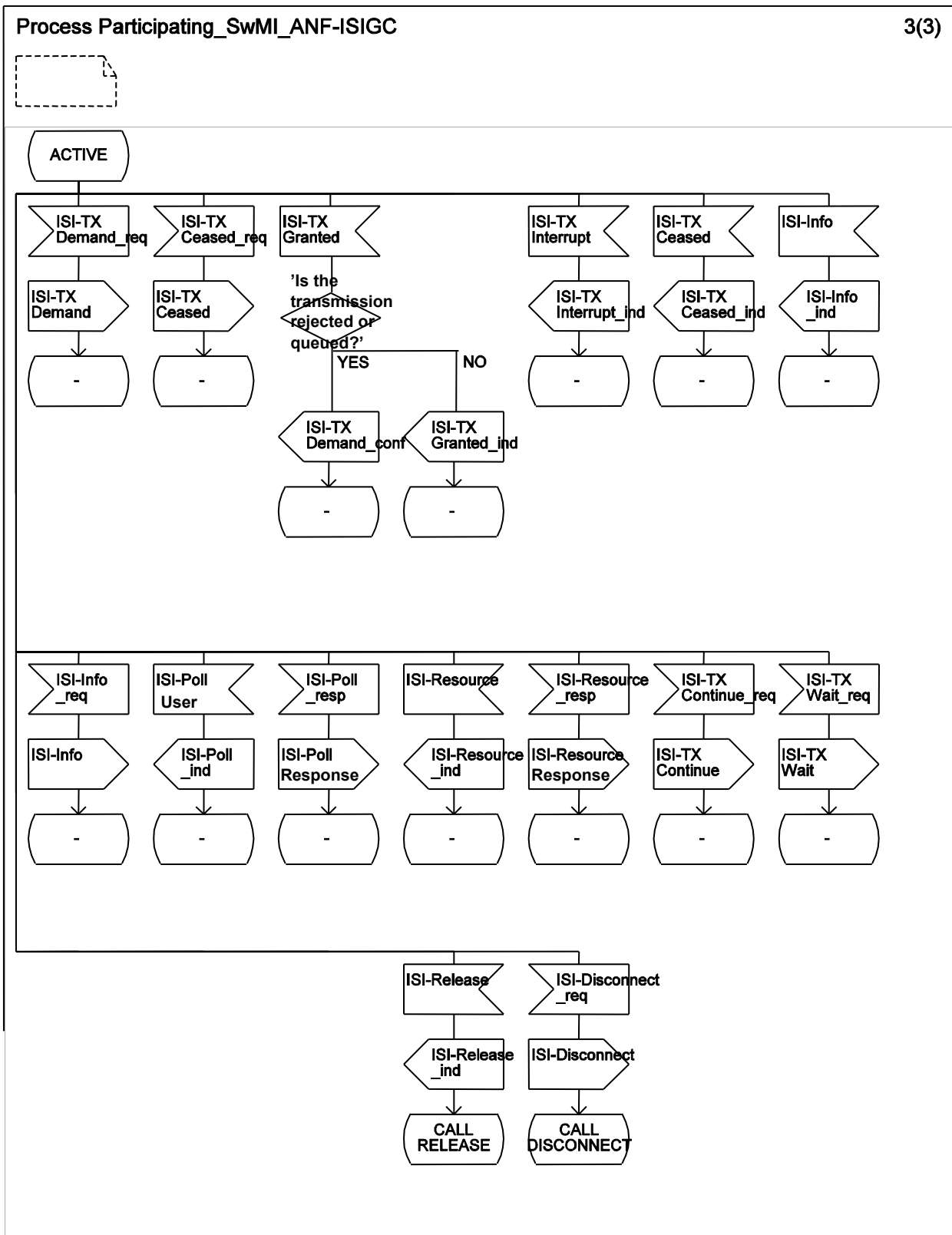

Figure A.10: SDL for participating SwMI ANF-ISIGC entity

Annex B (normative): Stage 2 description of the interactions between ANF-ISIGC and SS-CAD when invoked for the called group

B.1 Information flow diagrams

B.1.1 Group call set-up when SS-CAD is invoked for called group

In the case of incoming calls to a restricted group, the supplementary service CAD shall be invoked by the group home SwMI when a call request to the restricted group is received. If authorization is required by a dispatcher, three methods of call set-up may be made.

For the **case 1 scenario** direct call set-up shall be made between the calling user and the dispatcher. Indication sent to the calling user, that the call has been temporarily diverted, is optional. If the call is authorized by the dispatcher, indication of acceptance should be sent to the calling user and the dispatcher should be released. Figures B.1 to B.5 show a call set-up sequence using direct call set-up.

For the **case 2 scenario** a connection is made between the group home SwMI and the dispatcher. Indication sent to the calling user, that the call has been intercepted, is optional. If the call is authorized by the dispatcher, indication of acceptance should be sent to the calling user and the dispatcher should be released. Figures B.6 to B.8 show a call set-up sequence using call to dispatcher without call set-up to the calling user.

For the **case 3 scenario** call set-up shall only be made between the calling user and the dispatcher on-demand from the dispatcher. Indication sent to the calling user, that the call has been intercepted, is optional. If the dispatcher wishes to set-up a call to the calling user, call set-up will continue as for direct call set-up (see figures B.2 to B.5). If the call is authorized by the dispatcher, indication of acceptance should be sent to the calling user and the dispatcher should be released. Figures B.9 and B.10 show a call set-up sequence using on-demand call set-up to the calling user.

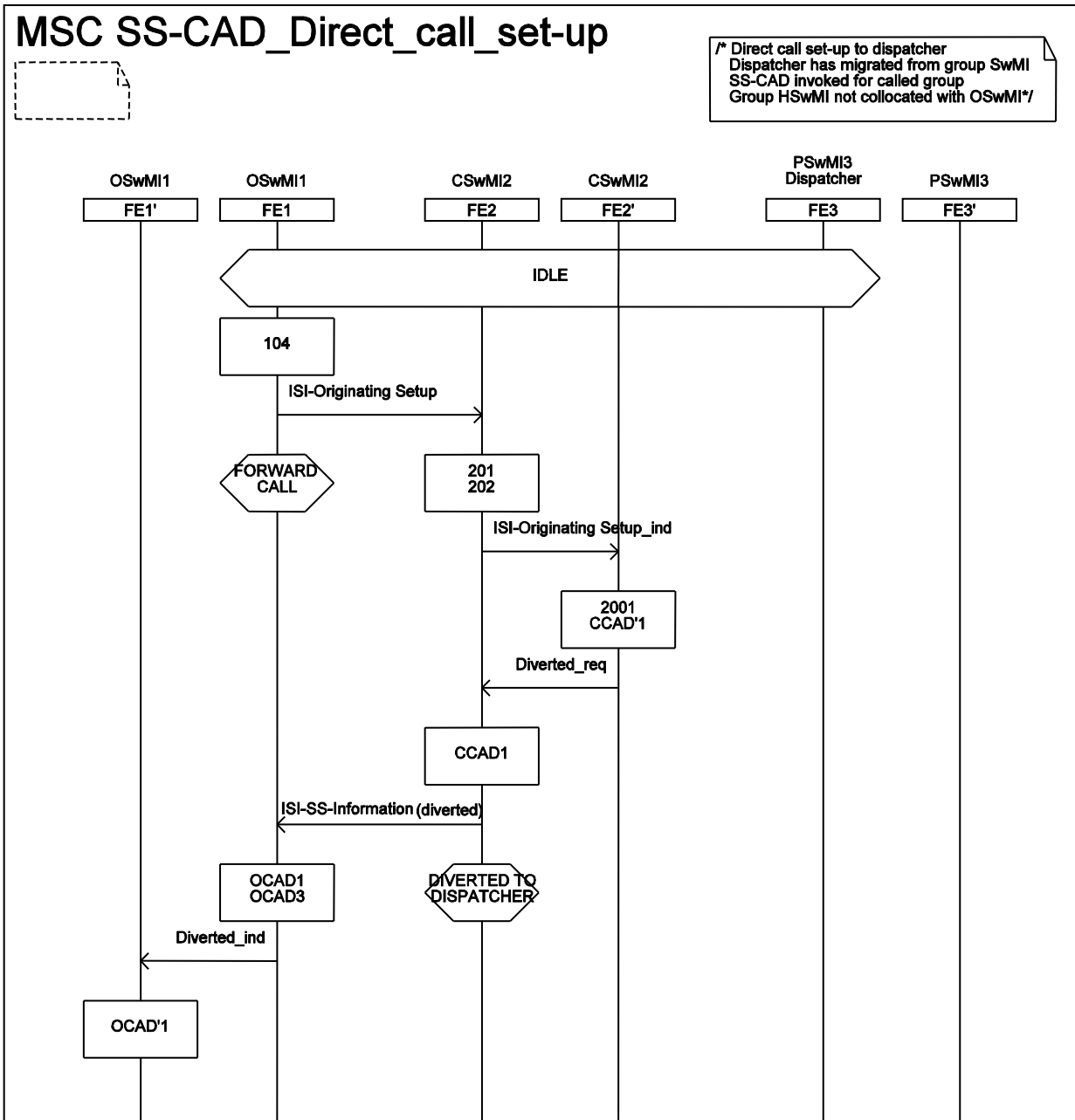

Figure B.1: Information flow sequence - Direct call set-up to dispatcher (sheet 1 of 5)

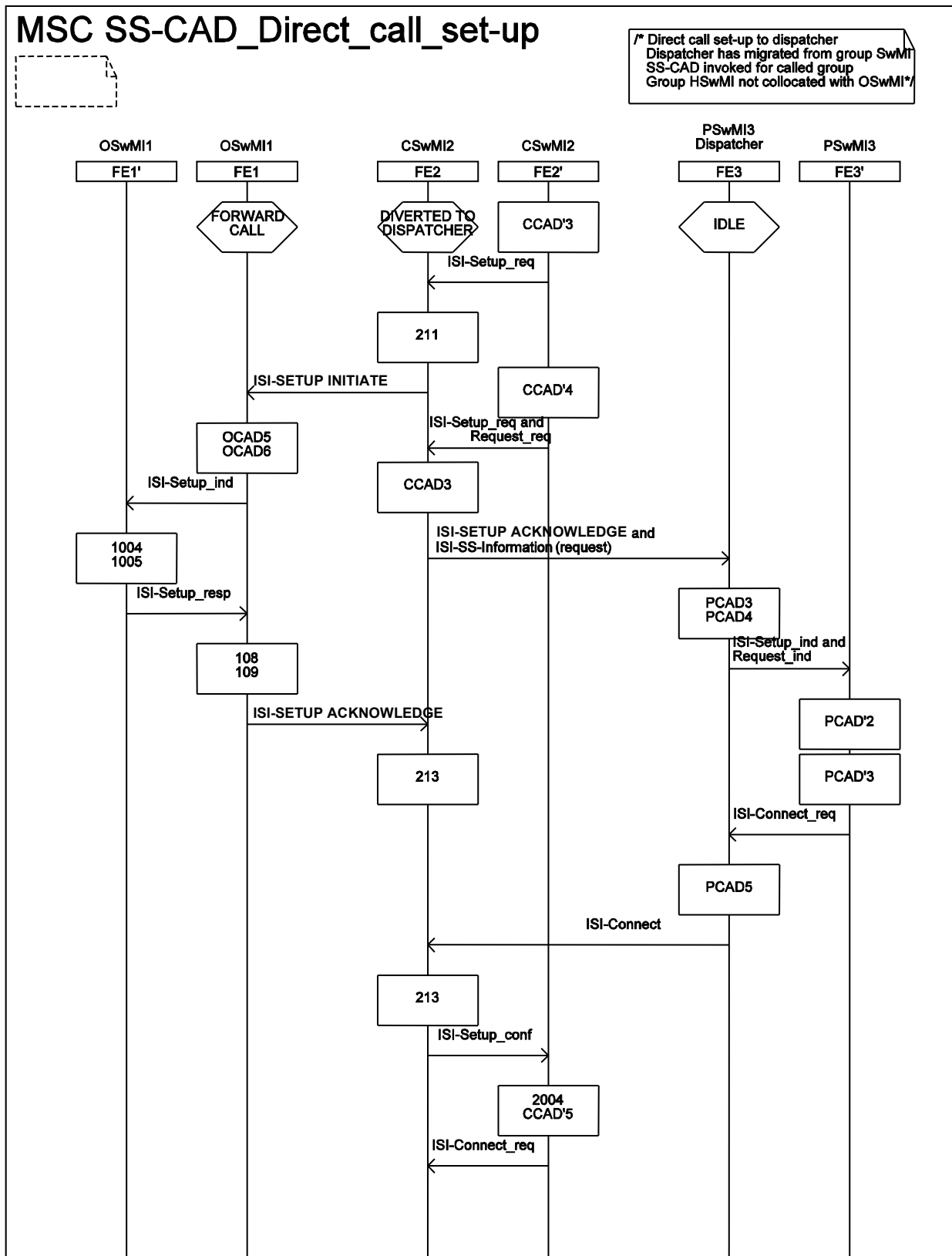

Figure B.2: Information flow sequence - Direct call set-up to dispatcher (sheet 2 of 5)

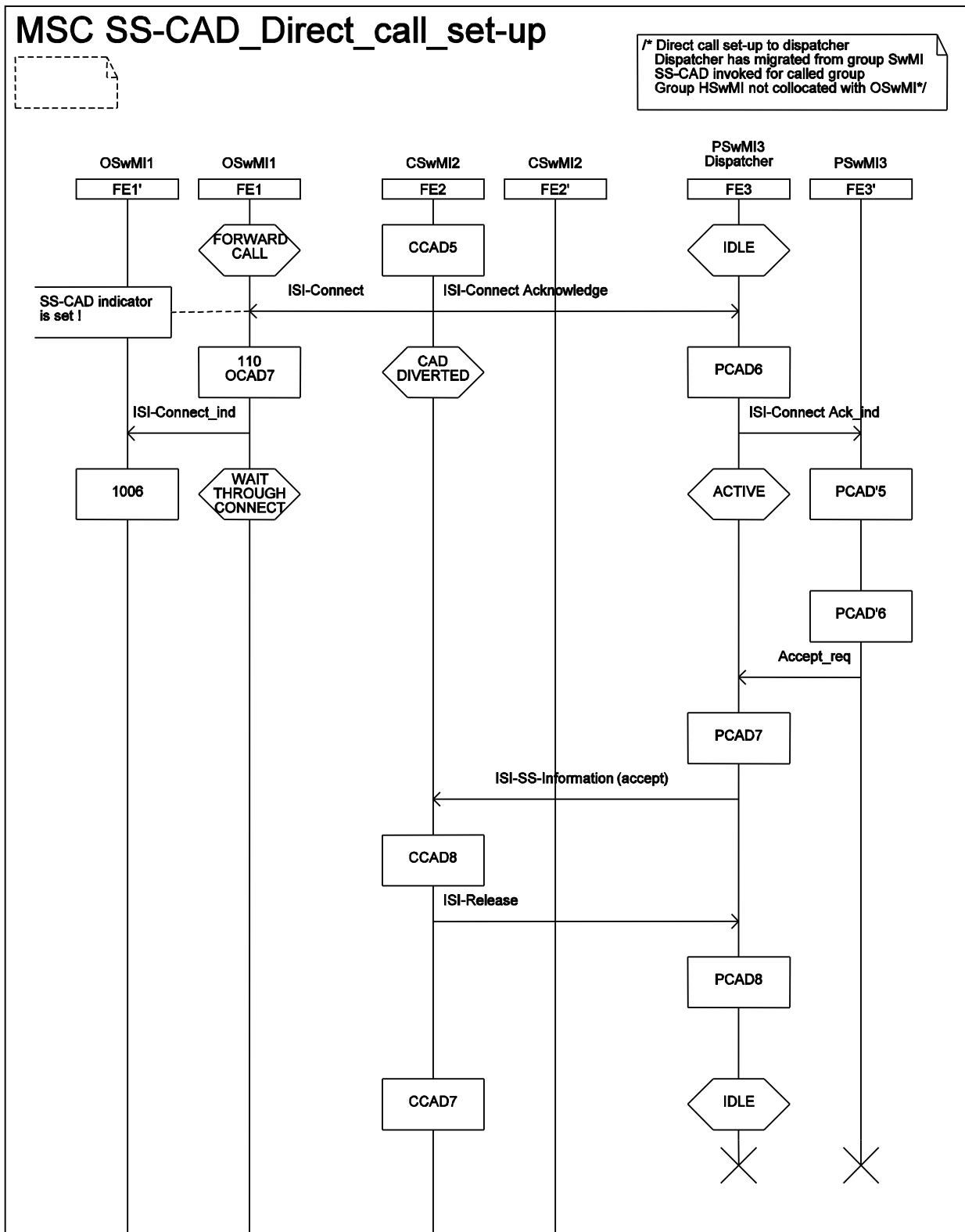

Figure B.3: Information flow sequence - Direct call set-up to dispatcher (sheet 3 of 5)

MSC SS-CAD_Direct_call_set-up



/* Direct call set-up to dispatcher
 Dispatcher has migrated from group SwMI
 SS-CAD invoked for called group
 Group HSwMI not collocated with OSwMI*/

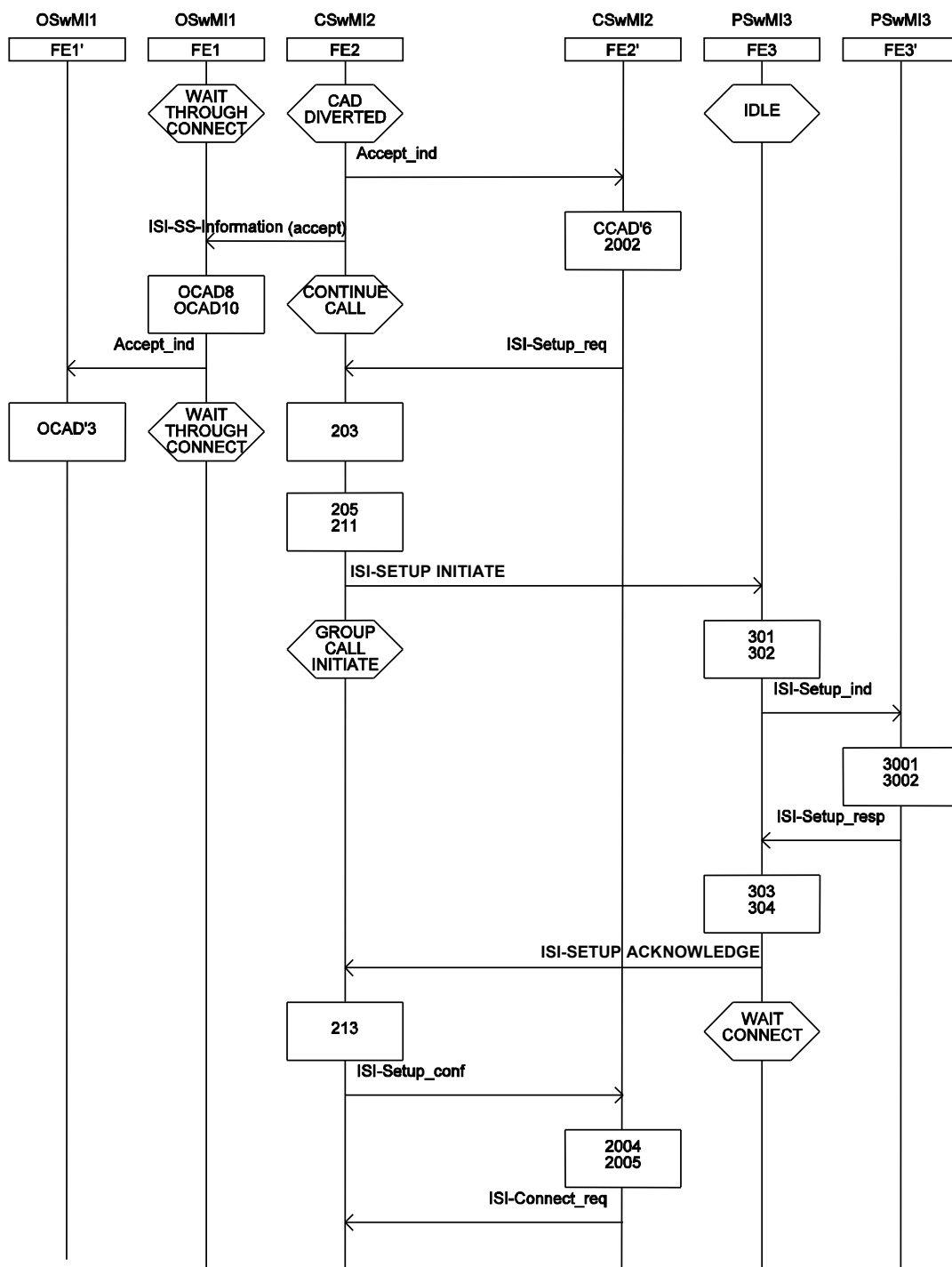

Figure B.4: Information flow sequence - Direct call set-up to dispatcher (sheet 4 of 5)

MSC SS-CAD_Direct_call_set-up



/* Direct call set-up to dispatcher
 Dispatcher has migrated from group SwMI
 SS-CAD invoked for called group
 Group HSwMI not collocated with OSwMI!*/

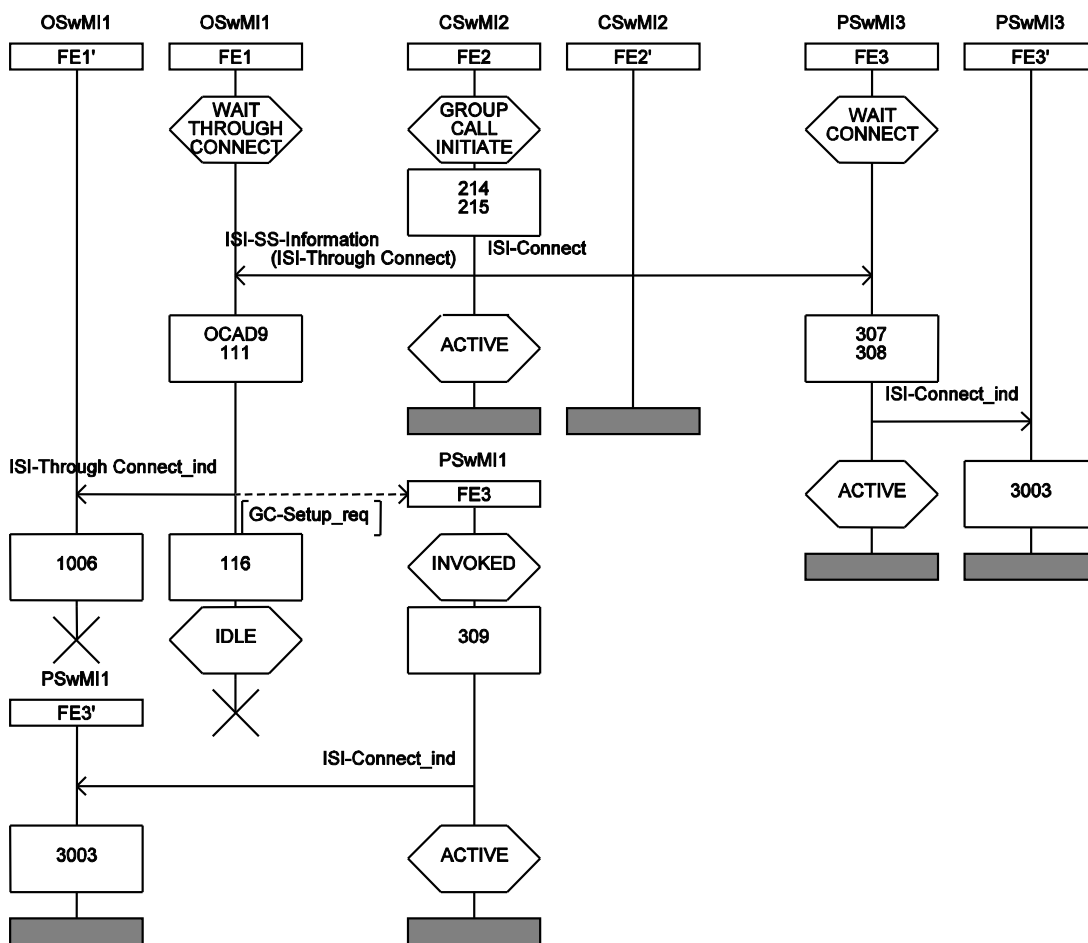

Figure B.5: Information flow sequence - Direct call set-up to dispatcher (sheet 5 of 5)

Upon reception of the group addressed ISI-SETUP ind. with the SS_CAD indicator set, the originating SwMI shall evaluate if the group call can be performed and reserve resources for the group call. However, the group members shall not be connected until a ThroughConnect ind. is received from the controlling SwMI.

The resources reserved in the originating SwMI shall upon reception of the group ISI-SETUP ind. remain reserved until a ThroughConnect ind. or ISI-RELEASE ind. is received. At this point, the group call is either connected to the members of the group call in the originating SwMI using the reserved resources or the resources are released because the call could not be set-up.

MSC SS-CAD_Call_without_call_set-up



/* Call to dispatcher without call set-up
 Dispatcher has migrated from group SwMI
 SS-CAD invoked for called group
 Group HSwMI not collocated with OSwMI*/

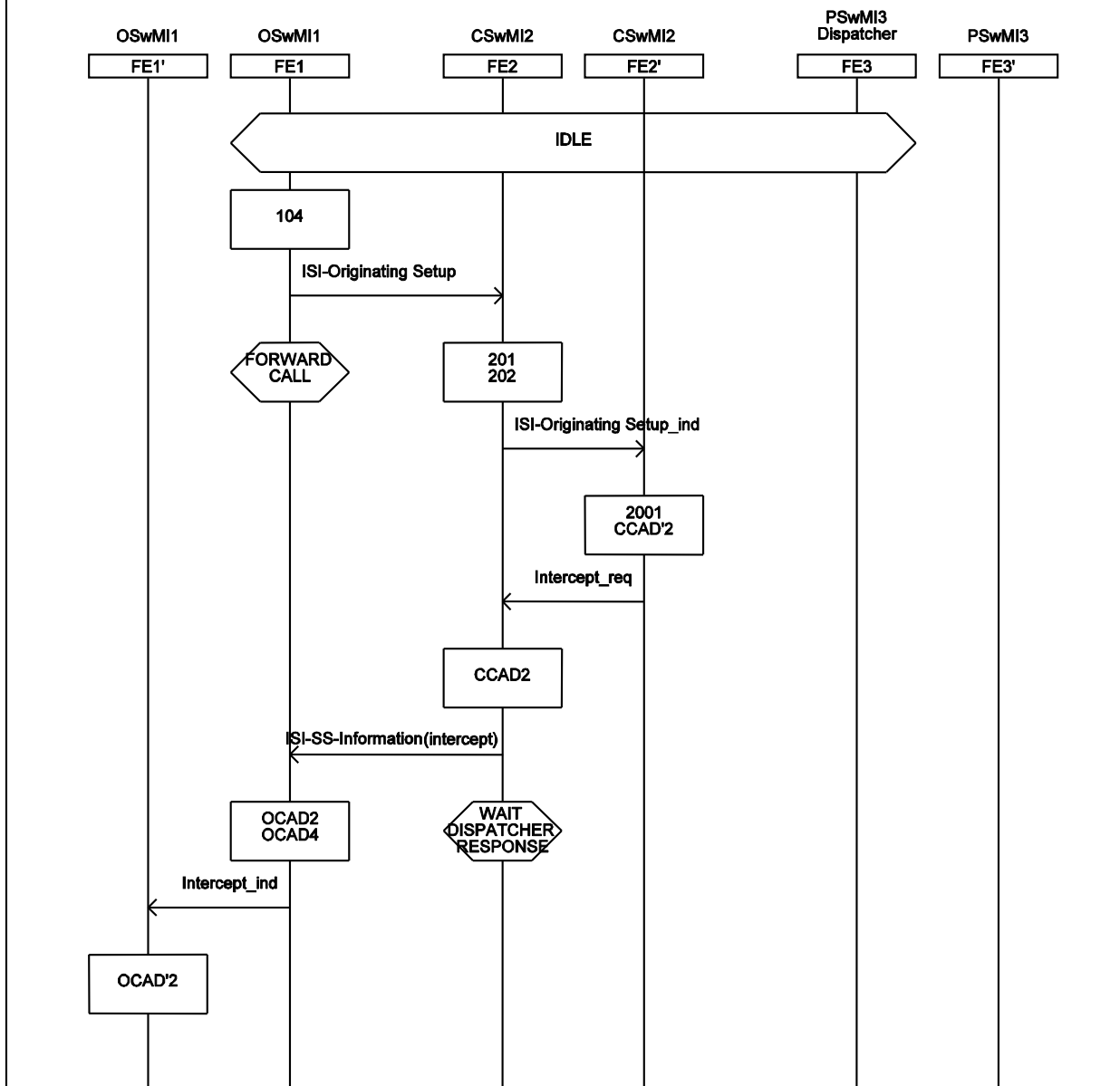

Figure B.6: Information flow sequence - Call to dispatcher without call set-up (sheet 1 of 3)

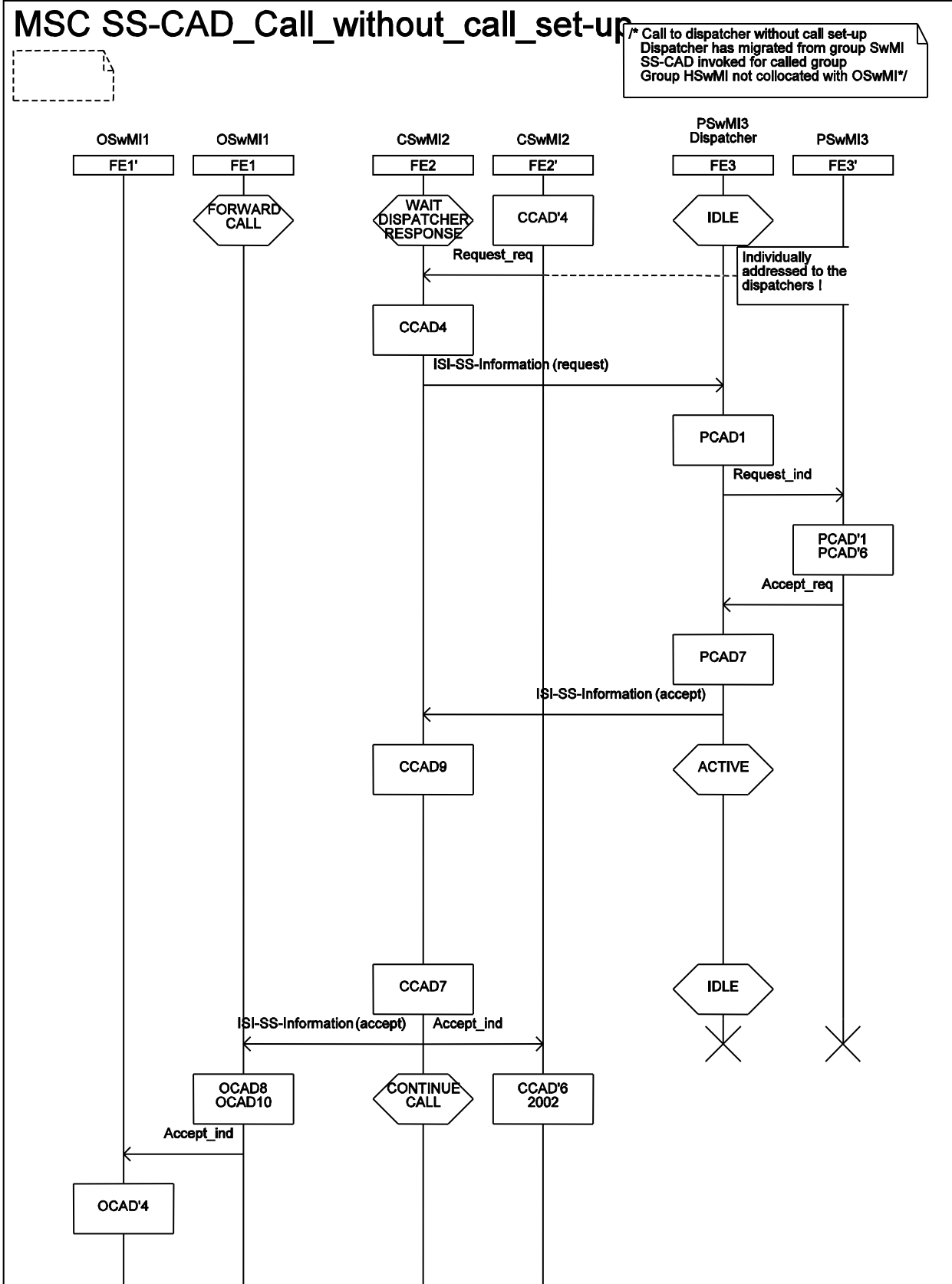
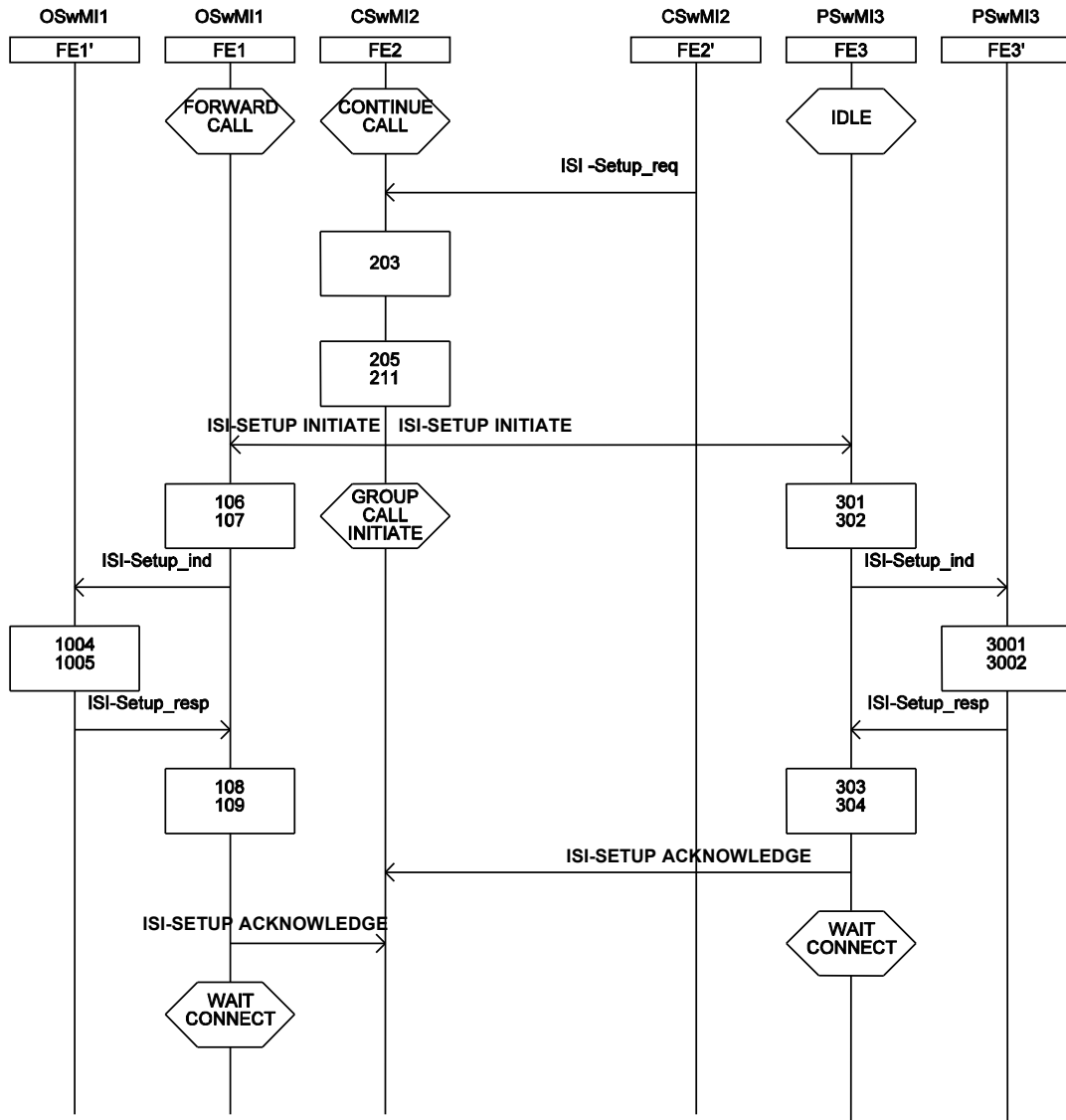

Figure B.7: Information flow sequence - Call to dispatcher without call set-up (sheet 2 of 3)

MSC SS-CAD_Call_without_call_set-up



* Call to dispatcher without call set-up
 Dispatcher has migrated from group SwMI
 SS-CAD invoked for called group
 Group HSwMI not collocated with OSwMI*/



NOTE: See figures 21 to 22 for the completion of call set-up.

Figure B.8: Information flow sequence - Call to dispatcher without call set-up (sheet 3 of 3)

MSC SS-CAD_On-Demand_call_set-up

/* On-Demand call set-up to the dispatcher
 Dispatcher has migrated from group SwMI
 SS-CAD invoked for called group
 Group HSwMI not collocated with OSwMI*/

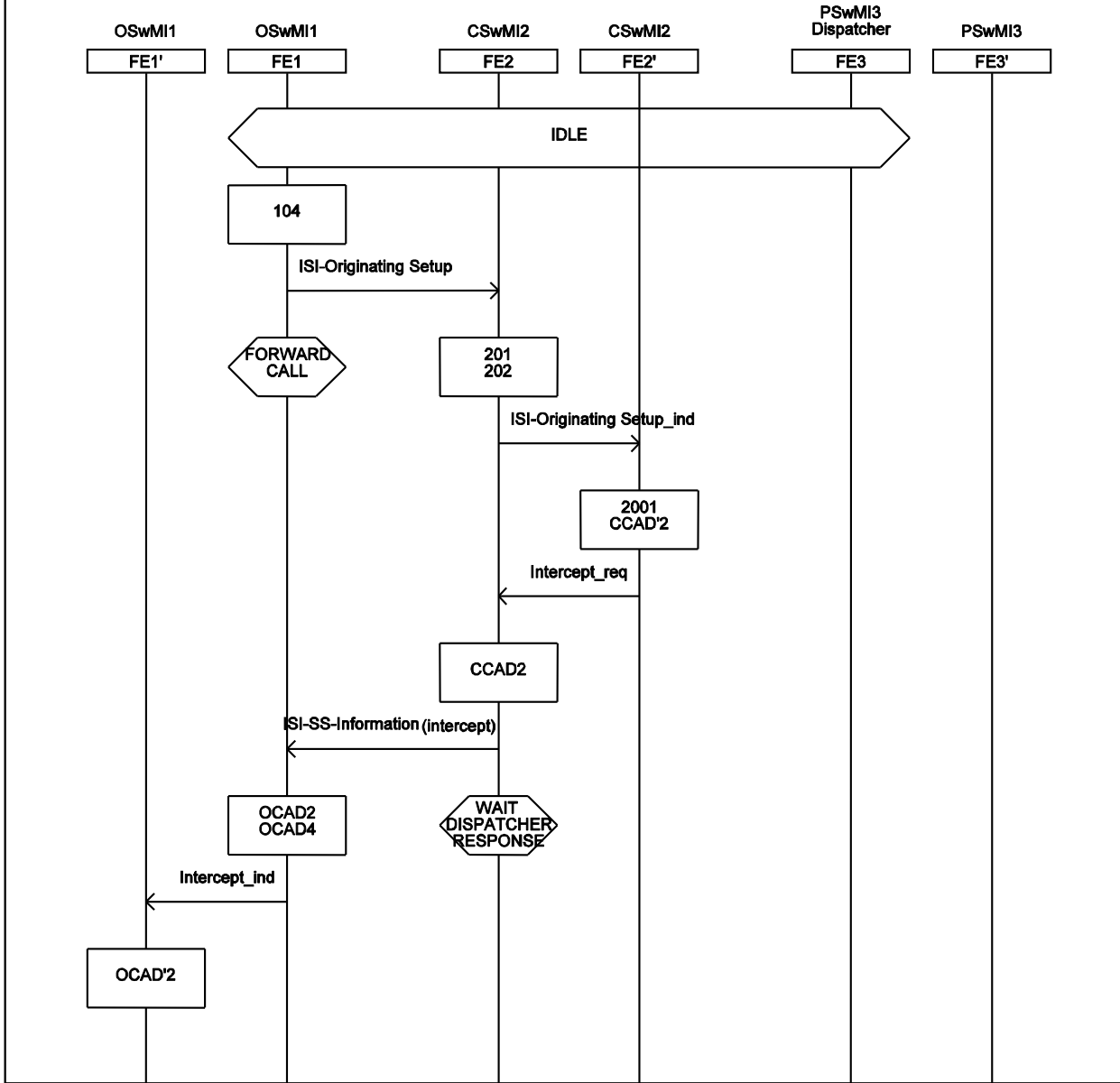
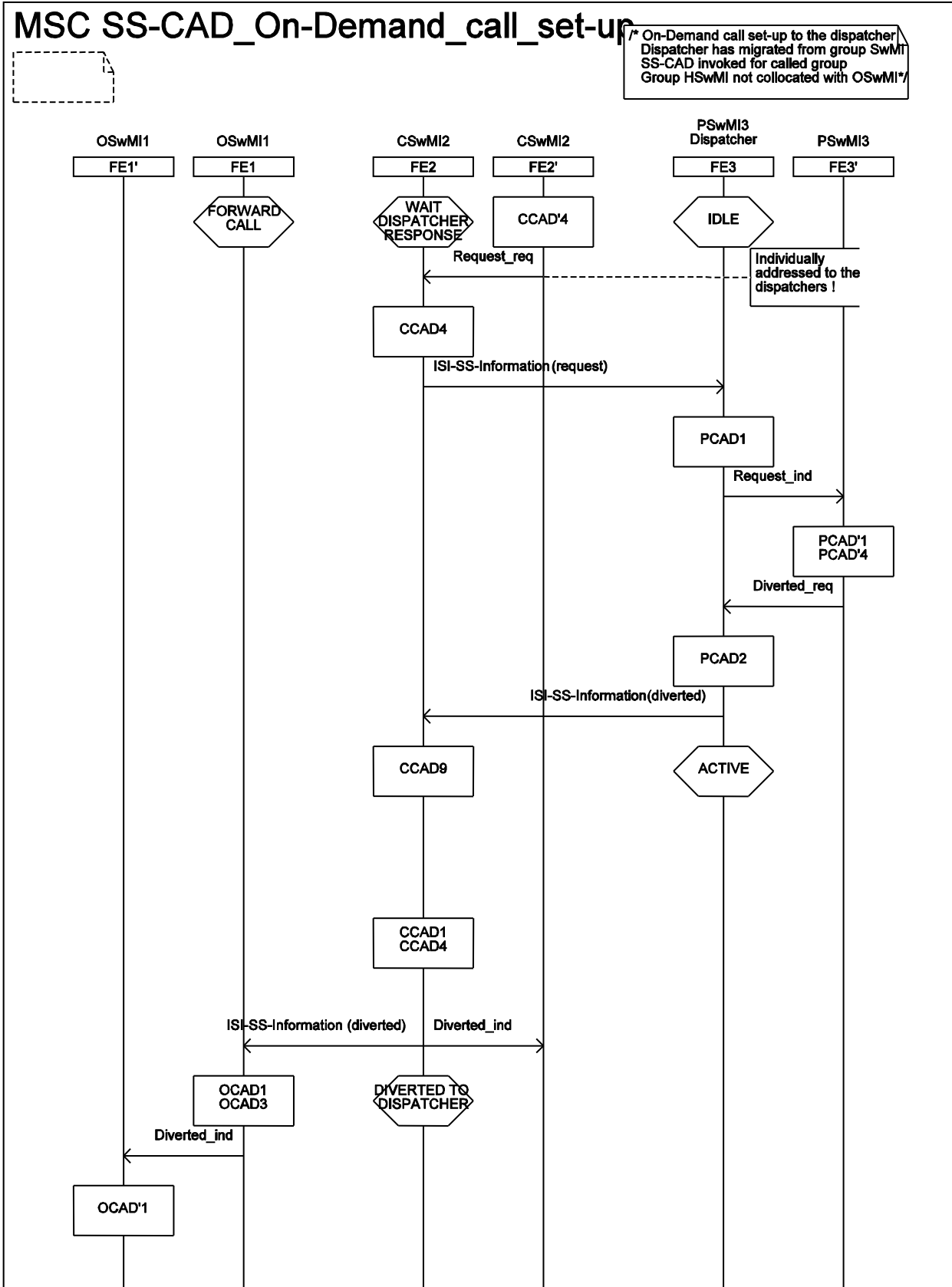

Figure B.9: Information flow sequence - On-demand call set-up (sheet 1 of 2)



NOTE: See figure CAD2 to CAD5 for the call set-up sequence.

Figure B.10: Information flow sequence - On-demand call set-up (sheet 2 of 2)

B.2 Definition of information flows

B.2.1 General

The information flow PDUs have been defined for SS_CAD when additional information needs to be added to the PDU. For a complete list of SS-CAD PDUs see ETSI EN 300 392-11-6 [6].

B.2.2 ISI_THROUGH CONNECT

ISI_THROUGH CONNECT is an unconfirmed information flow:

- across relationship rc from FE2 to FE1; and
- across relationship ra from FE1 to FE1'.

ISI_THROUGH CONNECT request/indication information flow shall be sent to the originating SwMI to inform it to through connect group members located in the originating SwMI.

Table B.1 lists the service elements within the ISI_THROUGH CONNECT information flow.

Table B.1: Content of ISI_THROUGH CONNECT

Service element	Req/Ind
Set-up type (full, partial)	M
Basic service information	C (see note 1)
Call priority (emergency, priority 1-14)	C (see note 1)
Call ownership	C (see note 1)
Call amalgamation	M
Transmission grant	M
Transmission request permission	M
Calling user identity	M (see note 2)
Call diverted to a dispatcher	M
Notification indicator	O
Proprietary	O
NOTE 1: Conditional on the value of call amalgamation. If the information element "call amalgamation" is not set, then the value of the information element shall be equal to the value received in the ISI-SETUP request primitive.	
NOTE 2: In the case of call amalgamation, only one of the original calling users shall become calling user for the group call. This information element shall contain this user's identity.	

B.3 Functional Entity Actions (FEAs)

B.3.1 General

Only the SS-CAD specific actions are stated below. For the complete list of basic call functional entity actions see clause 5.3.

B.3.2 Functional entity actions of FE1

- OCAD1 SS-CAD has been invoked for the called group. The group call request has been diverted.
- OCAD2 SS-CAD has been invoked for the called group. The group call request has been intercepted.
- OCAD3 Direct call set-up will be made to the dispatcher.

- OCAD4 Call set-up will not be made to the dispatcher or on-demand call set-up will be made with the dispatcher.
- OCAD5 Receive an individual addressed ISI_SETUP.
- OCAD6 Forward the set-up request to FE1'.
- OCAD7 Inform FE1' to connect the calling user using the reserved resources.
- OCAD8 The dispatcher has accepted the call. Call set-up to the called group will continue.
- OCAD9 The call is now to be through connected.
- OCAD10 Inform FE1' of the accepted call.

B.3.3 Functional entity actions of FE1'

- OCAD'1 The call has been diverted. Wait for a call set-up request to the dispatcher.
- OCAD'2 The call has been intercepted. Wait for acceptance from the dispatcher.
- OCAD'3 Wait for ISI_THROUGH CONNECT req. to the called group.
- OCAD'4 Wait for normal group call set-up.

B.3.4 Functional entity actions of FE2

- CCAD1 Send an ISI_DIVERTED to the FE1.
- CCAD2 Send an ISI_INTERCEPT PDU.
- CCAD3 Set-up the call to the dispatcher as an individual call and indicate that SS-CAD has been invoked (SS PDU REQUEST).
- CCAD4 Request the dispatcher to authorize the incoming group call.
- CCAD5 Send an ISI-CONNECT to FE1 to indicate that the calling user is to be connected and an ISI-CONNECT ACKNOWLEDGE to FE3 to indicate that the dispatcher is to be through connected.
- CCAD6 The call is to be diverted to the dispatcher (On-demand call set-up by dispatcher).
- CCAD7 The call has been accepted. Inform FE1 and FE2.
- CCAD8 Release the call to the dispatcher.
- CCAD9 Release the transport connection to the dispatcher's SwMI.

B.3.5 Functional entity actions of FE2'

- CCAD'1 The supplementary service SS-CAD has been invoked on the called group number. Direct call set-up will be made to the dispatcher. Inform the originating SwMI that the call has been diverted.
- CCAD'2 The supplementary service SS-CAD has been invoked on the called group. A call will not be set-up with the dispatcher. However, the dispatcher can choose to set-up a call with the calling user on demand.
- CCAD'3 Perform a direct set-up between the originating SwMI, FE1, and the participating SwMI were the dispatcher is located.
- CCAD'4 The call is to be authorized by a dispatcher. Send the SS PDU REQUEST to the SwMI where the dispatcher is located to indicate that the call has been intercepted.
- CCAD'5 Send an ISI_CONNECT req. to FE2 requesting that the diverted call be through connected.
- CCAD'6 The group call is accepted. Group call set-up can continue.

B.3.6 Functional entity actions of FE3

- PCAD1 Send a request to a dispatcher to authorize the incoming group call.
- PCAD2 Inform FE2 that the call shall be diverted to the dispatcher.
- PCAD3 Receive an individual addressed ISI-SETUP to a dispatcher.
- PCAD4 Forward the request to FE3'.
- PCAD5 Forward the connect to FE2.
- PCAD6 Inform the dispatcher to through connect.
- PCAD7 Inform FE2 of the dispatcher acceptance.
- PCAD8 Release the dispatcher.
- PCAD9 Confirm that the transport connection has been released.

B.3.7 Functional entity actions of FE3'

- PCAD'1 Inform the dispatcher to evaluate the group call.
- PCAD'2 Evaluate if the necessary resources are available and that the migrated dispatcher exist in the SwMI. If the call can be performed in the participating SwMI, then send a set-up request to the dispatcher.
- PCAD'3 The dispatcher has accepted the call. Inform the controlling SwMI.
- PCAD'4 The dispatcher wishes to set-up a call to the calling user (on-demand call set-up).
- PCAD'5 Send the connect acknowledge PDU to the dispatcher.
- PCAD'6 The incoming group call has been accepted by the dispatcher.

Annex C (informative): Signalling Diagram Examples

C.1 Call Setup

C.1.1 Call Setup General

The following clauses in this annex give examples of call set-up scenarios for some of the possible call acceptance and call connection modes.

The examples, deliberately, excludes air interface PDUs at the CSwMI. If users are located in a SwMI with the Controlling SwMI functionality this SwMI will also include the Originating SwMI functionality or the Participating SwMI functionality. The signalling between the Originating SwMI and the Controlling SwMI or the Controlling SwMI and the Participating SwMI will then be SwMI internal.

NOTE 1: The PDU names in the figures are using mixed cases although the text is using upper case presentation.

NOTE 2: Information element content in (brackets) is optional.

C.1.2 Single calling party, no queuing for resources

- CSwMI connects on any strategy; and
- the CSwMI waits for all responses to its ISI-SETUP-INITIATE PDU before determining if the call can be connected. Refer to figure C.1.

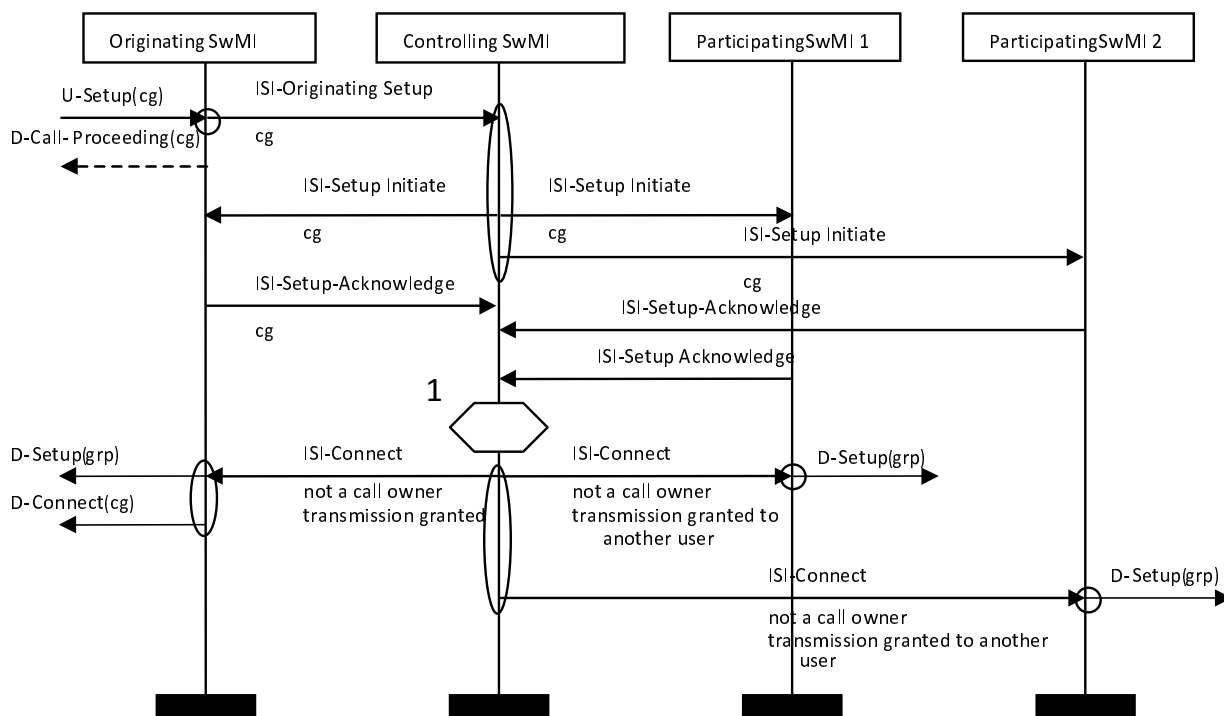

Figure C.1: Successful group call set-up: single calling party, no queuing for resources

NOTE 1: The CSwMI waits for all initial responses (ISI-SETUP-ACKNOWLEDGE or ISI-DELAY PDU) from all external SwMIs. It then performs an evaluation to determine if the call should be delayed (i.e. ISI-RELEASE PDU sent to ready SwMIs) or a partial call setup (i.e. send ISI-CONNECT PDU to ready SwMIs). In this case it has no (sensible!) option but to connect the call.

NOTE 2: Since there is no queuing there is never any need to release resources due to the CSwMI being unable to connect the call. So it does not matter, in this case, if the CSwMI is capable of sending ISI-RELEASE PDU during call setup or not.

NOTE 3: This is the normal and most common case.

C.1.3 Single calling party, some queuing for resources

- CSwMI connects when the OSwMI is ready; and
- the CSwMI waits for all responses to its ISI-SETUP INITIATE PDU before determining if the call can be connected. Refer to figure C.2.

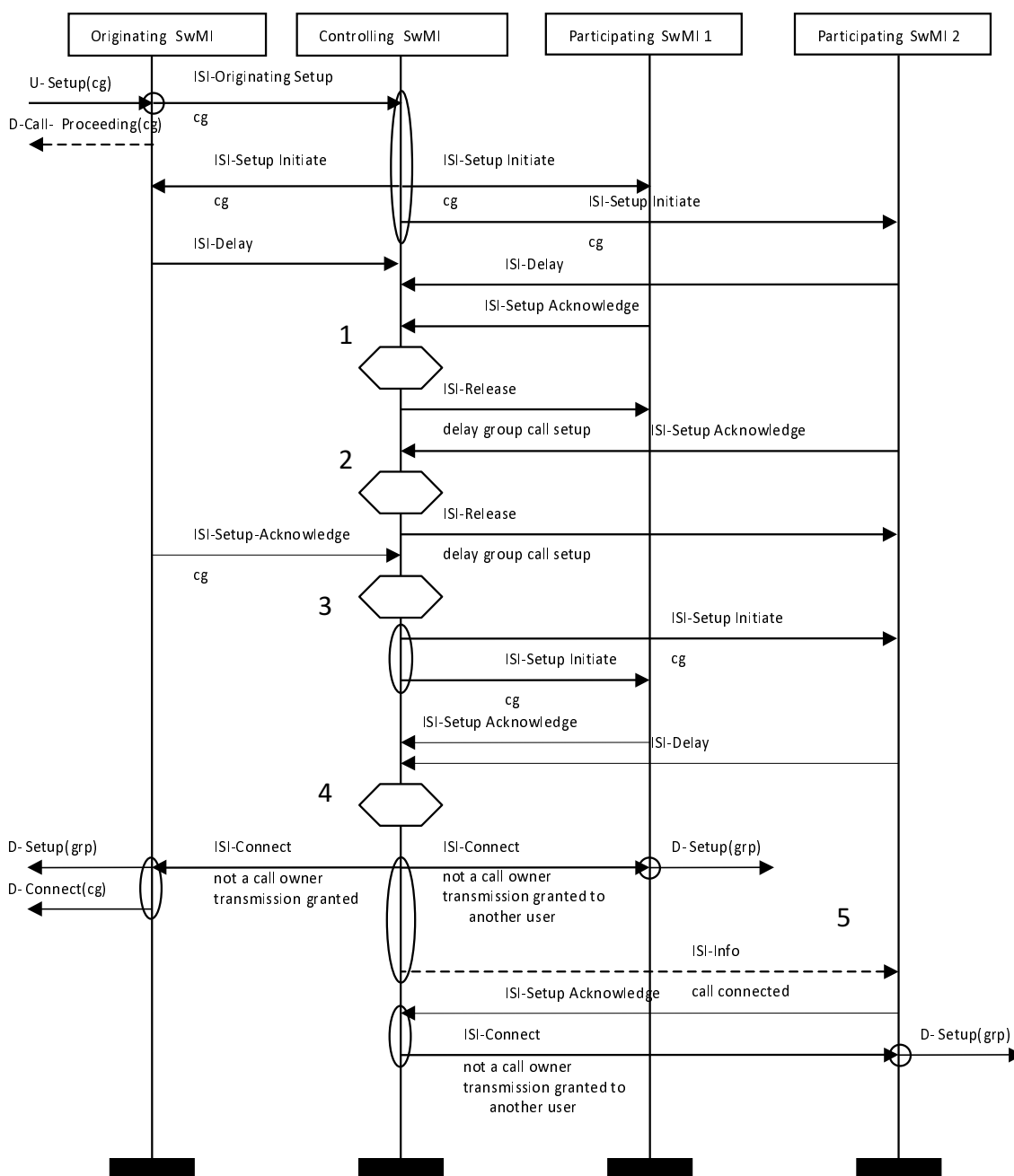

Figure C.2: Successful group call set-up: single calling party, some queuing for resources

NOTE 1: CSwMI waits for all initial responses (ISI-SETUP ACKNOWLEDGE or ISI-DELAY PDU) from all external SwMIs. It then performs an evaluation to determine if the call should be delayed (i.e. ISI-RELEASE PDU sent to ready SwMIs) or a partial call setup (i.e. send ISI-CONNECT PDU to ready SwMIs). In this case, since the CSwMI wants an OSwMI to be ready before it connects, but as it is not, it decides to delay the call.

NOTE 2: Any ISI-SETUP ACKNOWLEDGE PDU received after the CSwMI has delayed the call causes a new re-evaluation of what the CSwMI should do. The alternatives are to continue to delay the call (send an ISI-RELEASE PDU to the newly ready SwMI) or attempt to get the call to setup (by initiating the call again to all delayed SwMIs). In the example since the OSwMI is still not ready the CSwMI decides to continue to delay the call.

NOTE 3: The condition that the CSwMI is looking for is fulfilled when the ISI-SETUP ACKNOWLEDGE PDU comes in from the OSwMI. As in 2) a re-evaluation is performed but this time a decision is taken to try to reactivate the call. This is because the call can now be connected. To do this an ISI-SETUP-INITIATE PDU is sent to all delayed SwMIs (those that have been sent ISI-RELEASE PDU).

NOTE 4: When all of the responses to the ISI-Setup-Initiate have been received (ISI-SETUP ACKNOWLEDGE or ISI-DELAY PDU) then another re-evaluation is performed. In this example, the CSwMI decides to connect the call, so ISI-CONNECT PDU is sent to all SwMIs that are ready to connect. In the example one of the SwMIs is not ready to connect. It will be connected later when it sends in its ISI-SETUP ACKNOWLEDGE PDU.

NOTE 5: If the delaying SwMIs strategy on sending in its ISI-SETUP ACKNOWLEDGE PDU is to wait for more than one of its called parties to be ready then there will be parties that are ready but have not been connected into the call. The PSwMI may take account of the ISI-INFO PDU (call connected) to return its ISI-SETUP ACKNOWLEDGE PDU when a party can be connected into the call, thus avoiding the problem.

It is possible that the call has been connected without a calling party. This would be the case if the OSwMI had not based the sending in of its ISI-SETUP ACKNOWLEDGE PDU on the basis of its called party being ready (for example it could have sent it in based on any party (called or calling) being available, and it was a called party that was available).

It is possible (but probably unlikely) that the call could have been connected with no called parties. This assumes that there are no ready called parties at the OSwMI and that the PSwMI did not wait for called parties to be ready before sending in its ISI-SETUP-ACKNOWLEDGE PDU.

C.1.4 Single calling party, some queuing for resources, different connect strategy

- CSwMI connects when the OSwMI and a PSwMI is ready; and
- the CSwMI waits for all responses to its ISI-SETUP INITIATE PDU before determining if the call can be connected. Refer to figure C.3.

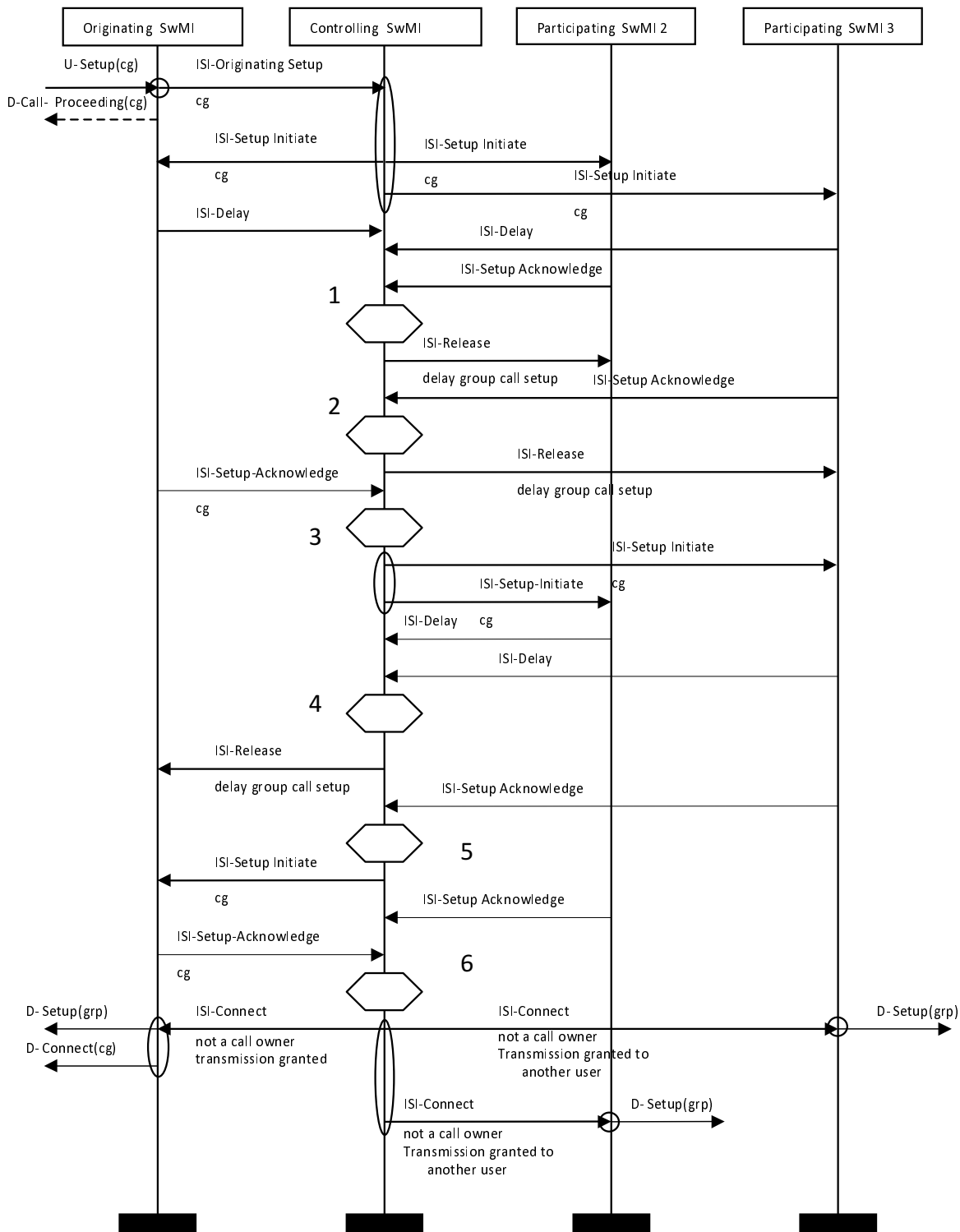

Figure C.3: Successful group call set-up: single calling party, some queuing for resources, different connect strategy to clause C.1.2

NOTE 1: CSwMI waits for all initial responses (ISI-SETUP ACKNOWLEDGE or ISI-DELAY PDU) from all external SwMIs. It then performs an evaluation to determine if the call should be delayed (i.e. ISI-RELEASE PDU sent to ready SwMIs) or a partial call setup (i.e. send ISI-CONNECT PDU to ready SwMIs). In this case since the CSwMI wants the OSwMI and a PSwMI to be ready before it connects, but only a PSwMI is ready, it decides to delay the call.

- NOTE 2: Any ISI-SETUP ACKNOWLEDGE PDU received after the CSwMI has delayed the call causes a new re-evaluation of what the CSwMI should do. The alternatives are to continue to delay the call (send an ISI-RELEASE PDU to the newly ready SwMI) or attempt to get the call to setup (by initiating the call again to all delayed SwMIs). In the example part of the conditions the CSwMI needs have been fulfilled, a PSwMI is ready, however since the OSwMI is delaying the CSwMI decides to continue to delay the call.
- NOTE 3: As in note 2 a re-evaluation is performed when an ISI-SETUP ACKNOWLEDGE PDU is received but the CSwMI is delaying the call. This time a decision is taken to try to reactivate the call, this is because the OSwMI is now available and if one of the delayed PSwMIs was still to be available then the call could be connected. To do this an ISI-SETUP INITIATE PDU is sent to all delayed SwMIs (those that have been sent ISI-RELEASE PDU).
- NOTE 4: When all of the responses from the SwMIs that have been sent the ISI-SETUP INITIATE PDU have been received (ISI-SETUP ACKNOWLEDGE or ISI-DELAY PDU) then another re-evaluation is performed. In this example, both of the PSwMIs have sent an ISI-DELAY PDU. The CSwMI has not met the conditions it needs to connect the call and so decides that the call should again be delayed. It sends ISI-RELEASE PDU to all SwMIs that are ready. In this case this is only the OSwMI.
- NOTE 5: The receipt of an ISI-SETUP ACKNOWLEDGE PDU while the call is being delayed causes a new re-evaluation by the CSwMI of what it should do next. The CSwMI still only has part of the condition satisfied that it needs to connect the call (it has only a PSwMI available). Since the OSwMI is currently being delayed by the CSwMI, the CSwMI now decides to attempt to reactivate the call again. It sends an ISI-SETUP INITIATE PDU to all delayed SwMIs. In this case this is only the OSwMI.
- NOTE 6: The first ISI-SETUP ACKNOWLEDGE PDU to arrive is from the delaying PSwMI. This does not cause a re-evaluation of what the CSwMI should do, since the CSwMI is looking for responses from all of the SwMIs to which it has just sent an ISI-SETUP INITIATE PDU. This is not one of them (however, the CSwMI remembers that this PSwMI is no longer delaying itself). The next ISI-SETUP ACKNOWLEDGE PDU is from the OSwMI. Since all of the responses that the CSwMI had been looking for have now come in a re-evaluation is performed. This determines that both an OSwMI and a PSwMI are now available for connection. Therefore, the call is connected.

C.1.5 Single calling party, some queuing for resources, showing multiple releasing

- CSwMI connects when all SwMIs are ready.
- The CSwMI waits for all responses to its ISI-SETUP-INITIATE PDU before determining if the call can be connected. Refer to figure C.4.

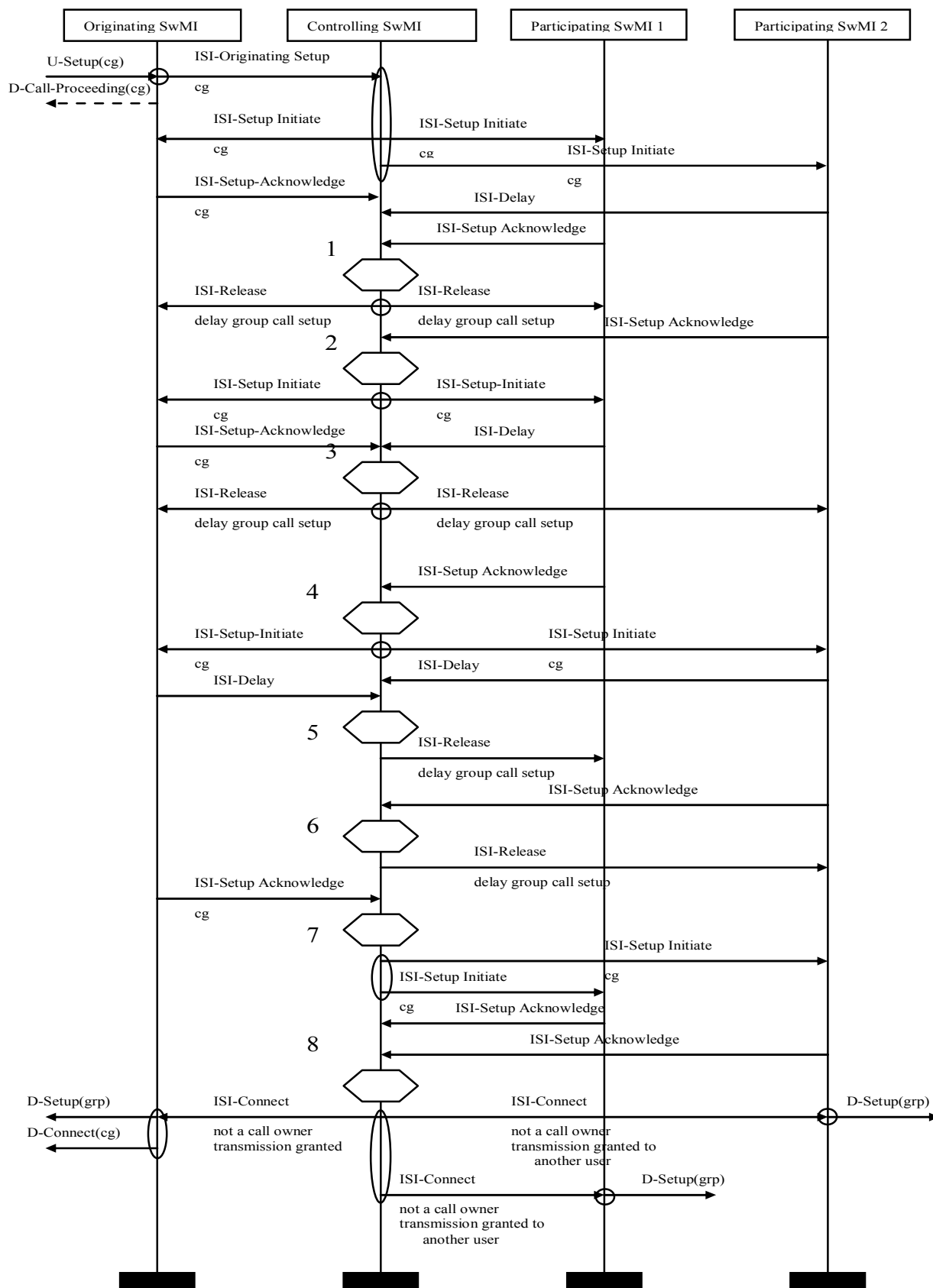

Figure C.4: Successful group call set-up: single calling party, some queuing for resources, showing multiple releasing

NOTE 1: After receiving all the expected responses the CSwMI delays the call since it does not have all SwMIs ready.

- NOTE 2: Re-evaluation while delaying. Decides in this case to re-activate the call since all of the other SwMIs, other than the one that just said it was ready, are being delayed.
- NOTE 3: A re-evaluation of what to do when all responses from the previous re-activation have been received. In this example the CSwMI delays the call again since it needs all three SwMIs to be available before connecting the call and one of them has delayed.
- NOTE 4: Re-evaluation while delaying. The only delaying SwMI is now ready, so the CSwMI decides to re-activate the call.
- NOTE 5: The CSwMI waits for all expected responses. When they arrive both indicate that the sending SwMIs are not ready to connect.
- NOTE 6: Re-evaluation while delaying. Since one other SwMI is still delaying the CSwMI decides to delay the call.
- NOTE 7: Re-evaluation while delaying. No other SwMI is now delaying so the CSwMI decides to re-activate the call.
- NOTE 8: Once all of the expected responses have been received the CSwMI re-evaluates what it should do. At last it has all of the SwMIs ready, so it connects the call.

The "ping ponging" (the continual release and reacquisition of resources, while never quite getting all of the resources needed to connect the call) could go on for some considerable time. However, it cannot exceed the length of the "call timeout, set-up phase" timer.

C.1.6 Multiple calling parties, a new calling party is on a SwMI not currently in the call

- CSwMI connects when an OSwMI is ready.
- The CSwMI does not wait for all responses to its ISI-Setup-Initiate before determining if the call can be connected. Refer to figure C.5.

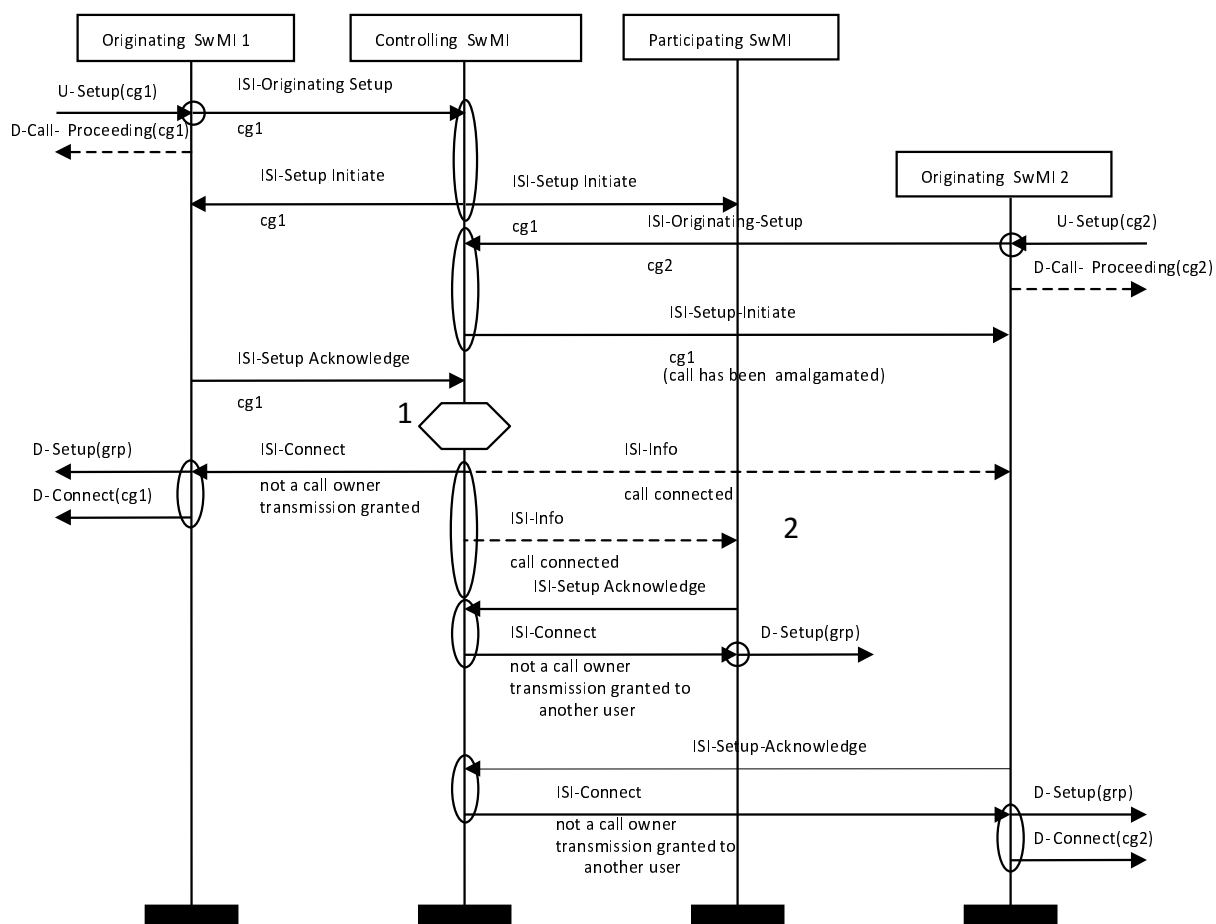

Figure C.5: Successful group call set-up: multiple calling parties, a new calling party is on a SwMI not currently in the call

NOTE 1: The CSwMI does not wait for all initial responses (ISI-SETUP ACKNOWLEDGE or ISI-DELAY PDU) from all external SwMIs. In this example the first response to come in, the ISI-SETUP ACKNOWLEDGE PDU from the OSwMI meets the CSwMI connection criteria. It therefore partially connects the call immediately and ISI-INFO PDUs are sent to all other SwMIs to inform them that the call has connected. A new OSwMI, that had no called parties, joined the call before the CSwMI connected it. The remaining SwMIs, including the newly joined SwMI, are connected into the call as soon as they are ready.

NOTE 2: The ISI-INFO PDUs could cause the receiving SwMIs to send back their ISI-SETUP ACKNOWLEDGES PDU sooner than was otherwise the case. This is because the SwMIs know that the call has connected and that any of their parties that are ready should be connected into the call.

C.1.7 Multiple calling parties, the new setup from the second OSwMI is received while the CSwMI is delaying the call

- CSwMI connects when an OSwMI and one PSwMI is ready.
- The CSwMI waits for all responses to its ISI-SETUP INITIATE PDU before determining if the call can be connected. Refer to figure C.6.

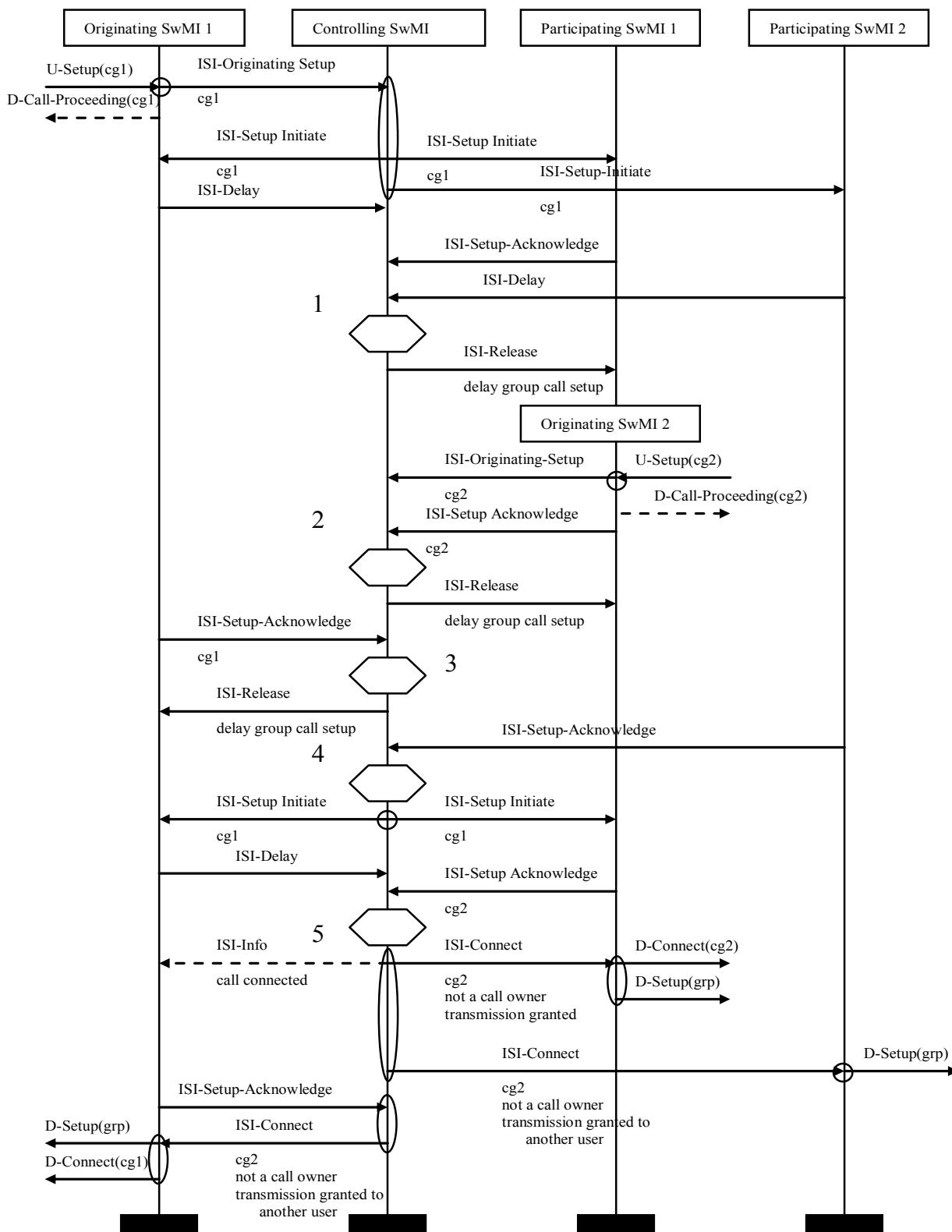

Figure C.6: Successful group call set-up: multiple calling parties, the new setup from the second OSwMI is received while the CSwMI is delaying the call

NOTE 1: After having waited for all of the expected responses the CSwMI decide to delay the call since it has not met the criteria it needs for call connection.

- NOTE 2: The new OSwMI sends in both its ISI-ORIGINATING SETUP and ISI-SETUP ACKNOWLEDGE PDU while the CSwMI is delaying the call. The CSwMI performs the usual re-evaluation, on receipt of the ISI-SETUP ACKNOWLEDGE PDU, while it is has delayed the call. Since the conditions needed for connection have not been met (no PSwMI) and the only PSwMI in the call is delaying the CSwMI decides to continue to delay the call. This illustrates an inefficiency, the OSwMI 1 will probably be basing the sending of its ISI-SETUP ACKNOWLEDGE PDU on having its calling party ready. In the situation of the example, it should probably say it is ready when any of its parties are ready. However, it has not been provided with any information that could allow it to decide to change its rule. This situation would not arise if the connection at the CSwMI were to be based only on having an OSwMI ready.
- NOTE 3: Re-evaluation during call delay. The CSwMI decides to continue to delay the call. Since it does not have the conditions it needs to connect the call and the only PSwMI in the call is still delaying. An alternative could be for the CSwMI to attempt to reinitiate the call since it has an OSwMI ready and would have another OSwMI ready if OswMI 2 reinitialized. This would require a connection rule in the CSwMI that allowed having two, or more, OSwMIs as enough to connect the call.
- NOTE 4: Re-evaluation during call delay. The PSwMI is now ready and so, since both of the OSwMIs are now delayed the CSwMI decides to re-activate the call.
- NOTE 5: When all of the expected responses are received, the usual re-evaluation determines that the call can now be connected. The delaying OSwMI is sent an ISI-INFO PDU (call connected) so that it is informed of the fact that the call has connected and so that it can decide if it wants any of its ready parties to also be connected into the call.

C.1.8 Multiple calling parties, the new setup from the second OSwMI is received while the CSwMI is activating the call

- CSwMI connects when an OSwMI and one PSwMI is ready.
- The CSwMI waits for all responses to its ISI-SETUP INITIATE PDU before determining if the call can be connected. Refer to figure C.7.

NOTE 3: Re-evaluation during call delay. The PSwMI is now ready and so, since both of the OSwMIs are now delayed the CSwMI decides to re-activate the call.

NOTE 4: When all of the expected responses are received, the usual re-evaluation determines that the call can now be connected. An ISI-INFO PDU (call connected) is sent to all delaying SwMIs at this time.

C.1.9 Multiple calling parties during delayed setup, a new calling party is on a SwMI not currently in the call

- CSwMI connects when all SwMIs are available.
- The CSwMI waits for all responses to its ISI-Setup-Initiate before determining if the call can be connected. Refer to figure C.8.

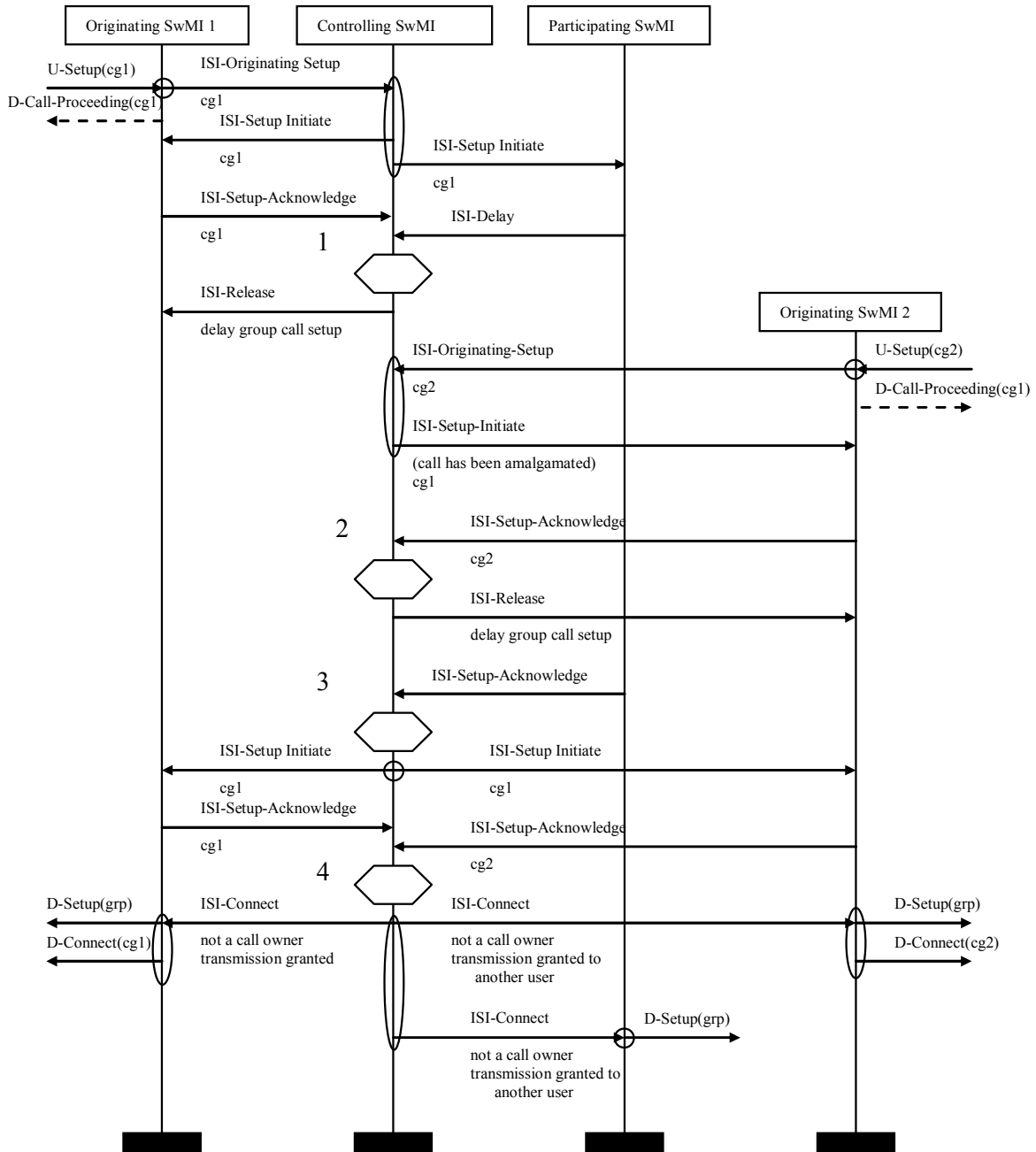

Figure C.8: Successful group call set-up: multiple calling parties during delay of call setup, the new calling party is on a SwMI not currently in the call

NOTE 1: After having waited for all of the expected responses the CSwMI decides to delay the call since it has not met the criteria it needs for call connection. It needs all SwMIs to be available but only one of them is.

NOTE 2: The new OSwMI has been added to the list of SwMIs in the call. Therefore, the ISI-SETUP ACKNOWLEDGE PDU from the new OSwMI causes a re-evaluation during call delay. The CSwMI decides to continue to delay the call. Since it does not have the conditions it needs to connect the call and the PSwMI in the call is still delaying. An alternative strategy here could be for the CSwMI to attempt to reinitiate the call. It depends entirely on the design of the CSwMIs re-evaluation algorithms what actually happens.

NOTE 3: Re-evaluation during call delay. The PSwMI is now ready and so, since both of the OSwMIs are now delayed the CSwMI decides to re-activate the call.

NOTE 4: When all of the expected responses are received, the usual re-evaluation determines, in this example, that the call can now be connected.

C.1.10 Multiple calling parties, a new calling party on a SwMI not currently in the call is granted transmission

- CSwMI connects when an OSwMI and one PSwMI are ready.
- The CSwMI does not wait for all responses to its ISI-SETUP INITIATE PDU before determining if the call can be connected. Refer to figure C.9.

- NOTE 3: The new OSwMI has been added to the list of SwMIs in the call. Therefore, the ISI-SETUP ACKNOWLEDGE PDU from the new OSwMI causes a re-evaluation during call delay. The CSwMI decides to re-initiate the call, since having two OSwMIs in the call should be enough to connect it. This illustrates a changing condition used by the CSwMI to connect the call, or a more complicated fixed rule, such as the CSwMI connects when it has an OSwMI and another SwMI ready. An alternative course of action from the CSwMI would be for it to continue to delay. It could do this because the PswMI is still delaying, and the response from the PswMI would kick off re-evaluation again. It depends entirely on the design of the CSwMIs re-evaluation algorithms what actually happens.
- NOTE 4: The CSwMI receives an ISI-SETUP ACKNOWLEDGE PDU from the PswMI. Since the CSwMI does not have to wait for the expected response from the ISI-SETUP INITIATE PDU it can re-evaluate immediately to decide what to do next. Because the PswMI is ready the CSwMI has the conditions it needs to connect the call. If the PswMI had not become ready, then the CSwMI may have delayed the call again or waited for the expected response from the OSwMI.
- NOTE 5: The OSwMI, since it has received an ISI-INFO PDU (call connected), sends back its ISI-SETUP ACKNOWLEDGE PDU because it knows it has at least one party that is capable of being connected into the call. It no longer has to wait for its calling party to be ready before returning the ISI-SETUP ACKNOWLEDGE PDU. If the OSwMI had decided to ignore the ISI-INFO PDU, and it had parties that could be connected into the call, these parties would not be connected until the OSwMI's conditions for sending its ISI-SETUP ACKNOWLEDGE PDU are met.

C.1.11 Multiple calling parties, the new calling party is granted transmission

- CSwMI connects when an OSwMI is ready.
- The CSwMI does not wait for all responses to its ISI-SETUP INITIATE PDU before determining if the call can be connected. Refer to figure C.10.

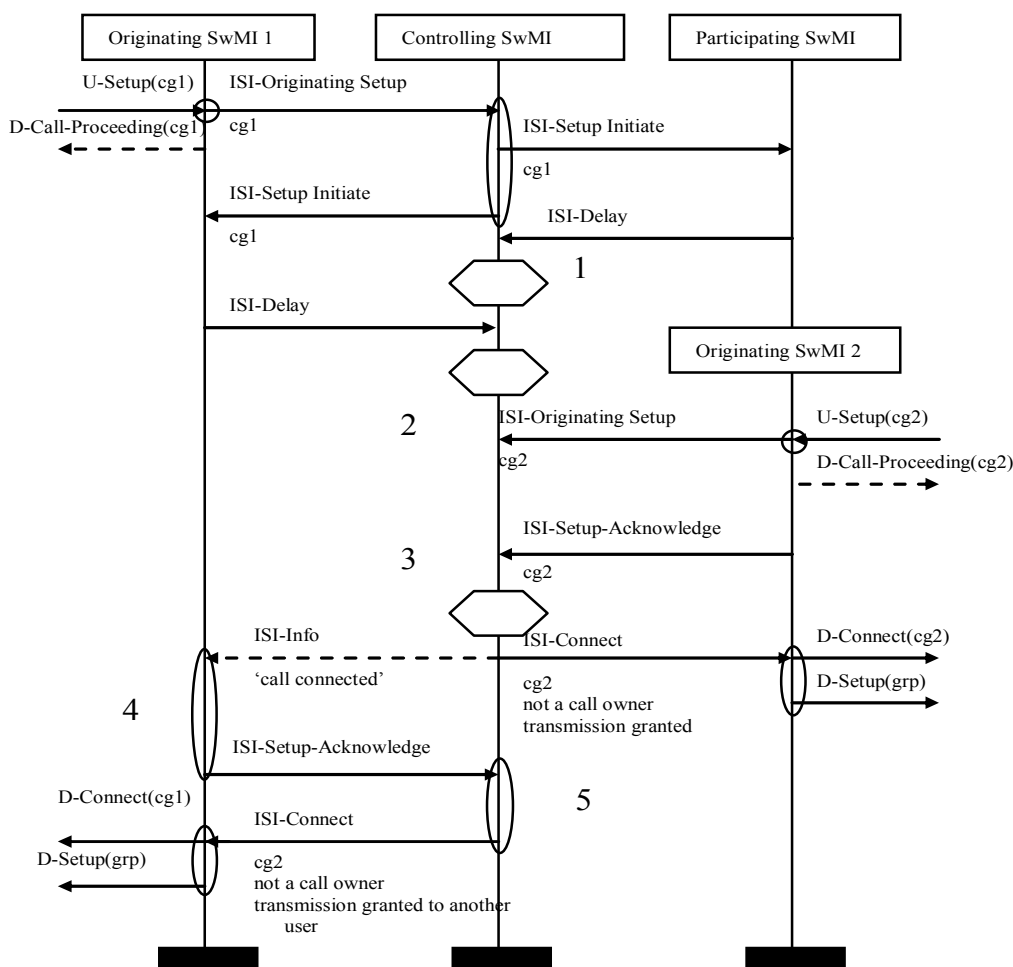

Figure C.10: Successful group call set-up: multiple calling parties the new calling party is granted transmission

- NOTE 1: Since the CSwMI is not waiting for all responses to its ISI-SETUP INITIATE PDU to determine what to do next, it performs an evaluation on every response to check if the call should be connected, delayed or left in its current state. In the example, the decision is neither to connect or delay since a response from another SwMI is still expected.
- NOTE 2: When the final expected response is received, the CSwMI decides to delay the call since it has not met the criteria it needs for call connection. However, since all of the external SwMIs are delaying the call there are no ISI-RELEASE PDUs to be sent.
- NOTE 3: The new OSwMI is recorded, by the CSwMI. Therefore, the ISI-SETUP ACKNOWLEDGE PDU from the new OSwMI causes a re-evaluation during call delay. The CSwMI decides to connect the call since it now has an OSwMI in the call the ISI-CONNECT and ISI-INFO PDUs are sent.
- NOTE 4: When the call connects the delaying SwMIs are informed. In the example, the OSwMI 1 decides that since it already has a party that can be connected into the call it immediately responds with its ISI-SETUP ACKNOWLEDGE PDU.
- NOTE 5: The CSwMI already being "active" connects the call to the SwMIs that send in ISI-SETUP ACKNOWLEDGE PDU.

C.1.12 Multiple calling parties, a PSwMI transitions back into a OSwMI

- CSwMI connects when an OSwMI is ready.
- The CSwMI does not wait for all responses to its ISI-SETUP-INITIATE PDU before determining if the call can be connected. Refer to figure C.11.

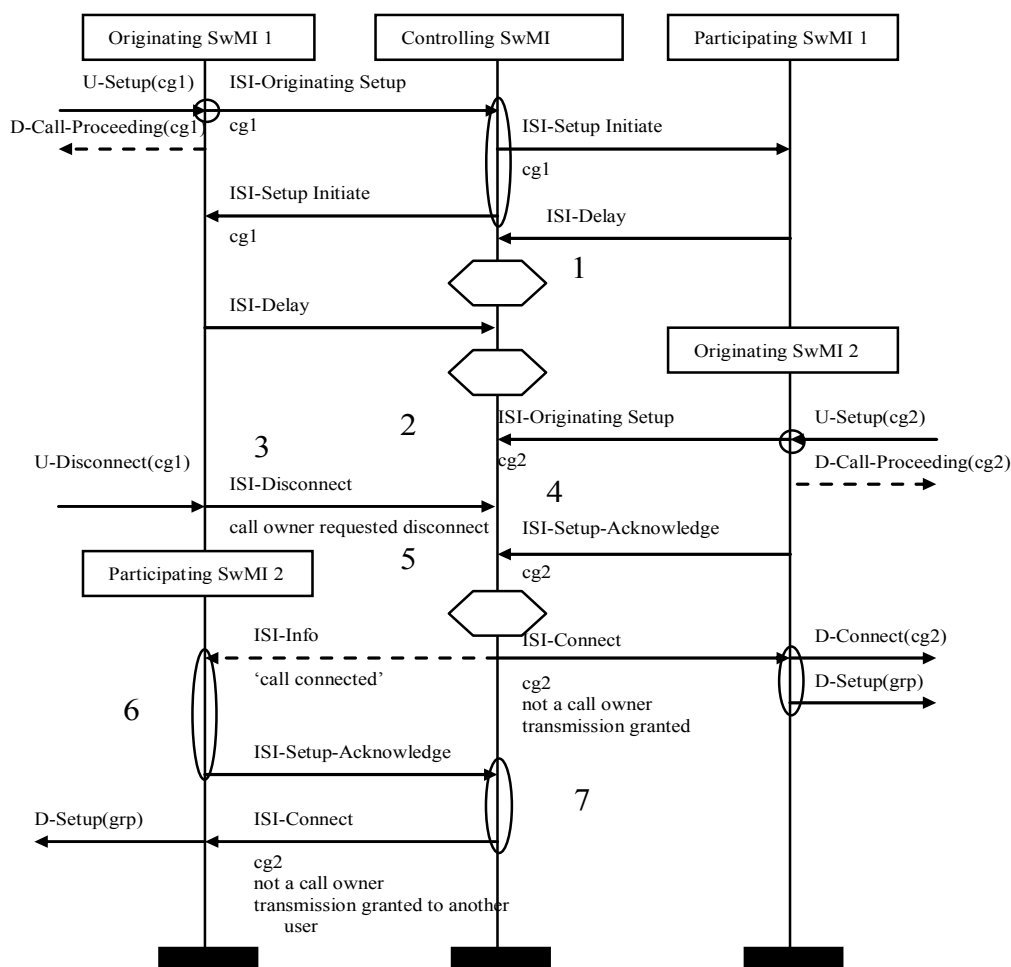

Figure C.11: Successful group call set-up: multiple calling parties a PSwMI transitions back into an OSwMI

- NOTE 1: Since the CSwMI is not waiting for all responses to its ISI-SETUP-INITIATE PDU to determine what to do next, it performs an evaluation on every response to check if the call should be connected, delayed or left in its current state. In the example, the decision is to neither connect, nor delay since a response from another SwMI is still expected.
- NOTE 2: When the final expected response is received the CSwMI decides to delay the call since it has not met the criteria it needs for call connection. However, since all of the external SwMIs are delaying the call there are no ISI-RELEASE PDUs to be sent.
- NOTE 3: The calling party at OSwMI1 disconnects from the call. Because there are no other calling parties at OSwMI1 it sends in an ISI-DISCONNECT PDU with the "call owner request" information element set to be "call owner requested disconnect". The ISI-DISCONNECT PDU is sent in a transport message which does not terminate the connection. The OSwMI 1 is now a PSwMI.

NOTE 3: The call is connected when the PSwMI responds, it does not matter which PDU, ISI-DELAY or ISI-SETUP-ACKNOWLEDGE PDU, the PSwMI responded with, in either case the connection criteria have already been fulfilled. However, it waits, in this example, for the PDU since the CSwMI does not connect until all responses to its ISI-SETUP-INITIATE PDU have been received.

C.1.15 Successful Group Call Establishment. The CSwMI does not accept more than one calling party

- CSwMI connects when an OSwMI is ready. Refer to figure C.14.

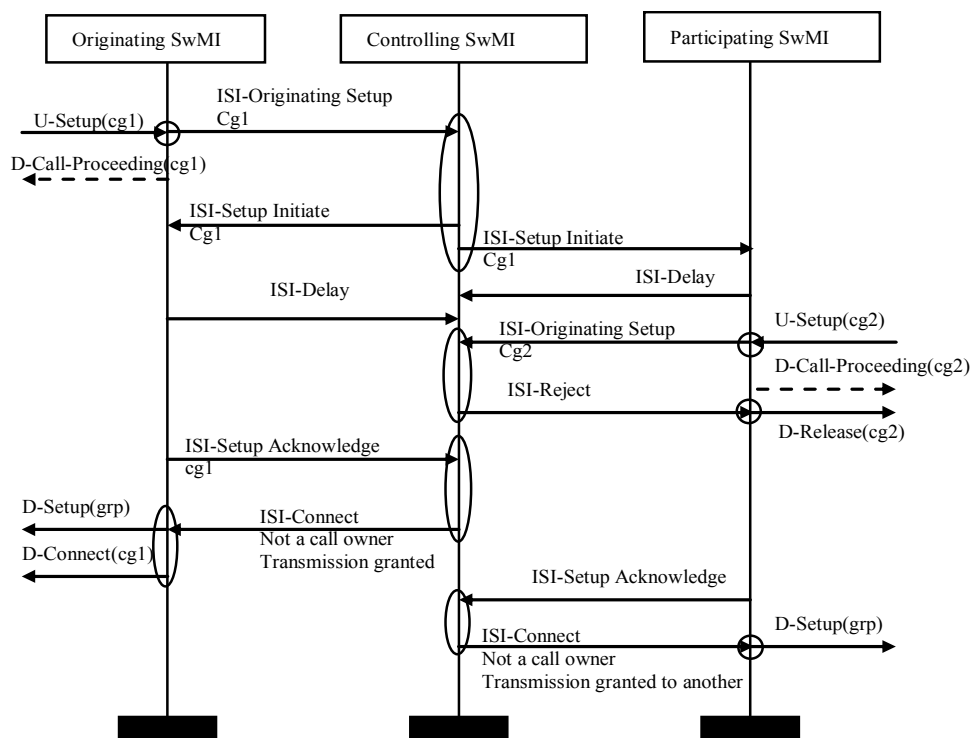

NOTE 1: The CSwMI may send ISI-REJECT PDU to a subsequent ISI-ORIGINATING-SETUP PDU if it does not support more than one OSwMI.

NOTE 2: The ISI-REJECT PDU is sent in a connection terminating message only if there are no group call participants at the receiving SwMI otherwise a message used for information transport is used.

Figure C.14: Successful group call set-up: CSwMI only supported one calling party

Description

A CSwMI may support only a single calling party. If it receives a second setup it may reject it. The call may still be established to the called group members on the rejected PSwMI.

C.1.16 Late Entry

Refer to figure C.15.

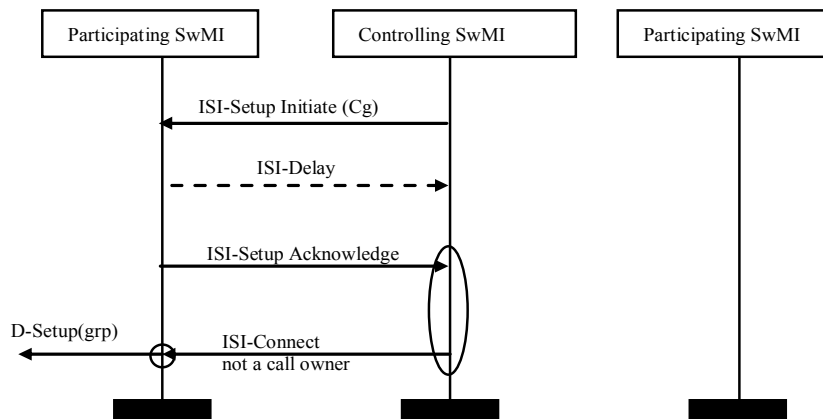

NOTE: A CSwMI may, at any time after call connection, send an ISI-SETUP INITIATE PDU to a SwMI which was not part of the original call but on which call members may be present. This action may be triggered, for example, by the expiration of a timer causing the CSwMI to re-evaluate the list of PSwMIs, or by the (linked) group attachment received from the SwMI. It constitutes the ISI part of the Late Entry Supplementary Service. Each SwMI is responsible for operation of SS-LE within it.

Figure C.15: Late entry

Description

The CSwMI sends ISI-SETUP INITIATE PDU to a new PSwMI for SS-LE. As the PSwMI does not have sufficient resources to connect it responds with ISI-DELAY PDU. When resources become available, the PSwMI sends ISI-SETUP ACKNOWLEDGE PDU. The CSwMI then connects the PSwMI into the call.

C.1.17 A SwMI joins with a Connected Call

Refer to figure C.16.

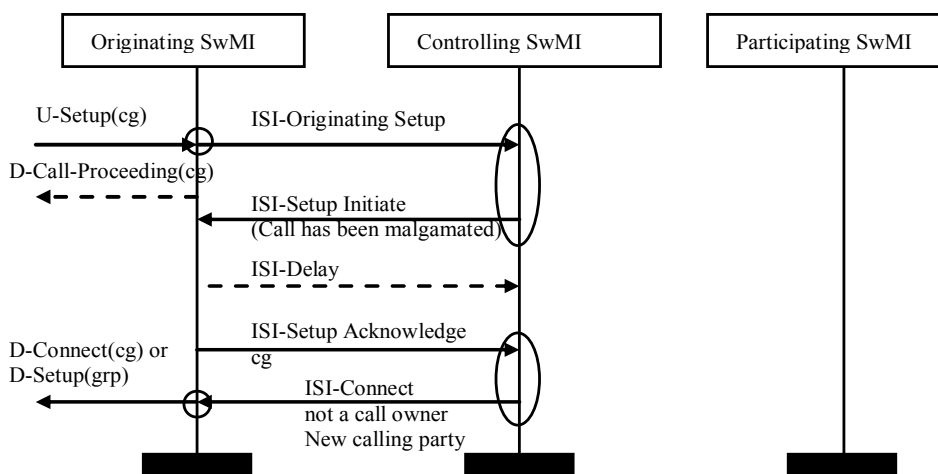

- NOTE 1: The PSwMI and CSwMI are already in a group call that is called by the party at the OSwMI.
 NOTE 2: The joining party is told that it is not the owner of the call.
 NOTE 3: The CSwMI may send ISI-REJECT PDU in response to the ISI-ORIGINATING-SETUP PDU if it does not wish to allow the SwMI to enter the existing call.
 NOTE 4: If the joining mobile or the OSwMI disconnect before the D-CONNECT PDU is sent then only the OSwMI is released, not the entire call.

Figure C.16: A Party joins with an Active Call

Description

On receiving an ISI-ORIGINATING-SETUP PDU for a group call that is already connected, the CSwMI may allow the party to join in with the existing call. It does this by initiating a call with joining SwMI only.

C.1.18 An emergency priority call to a group that is already in an active, non-emergency, call

- CSwMI connects when an OSwMI is ready. Refer to figure C.17.

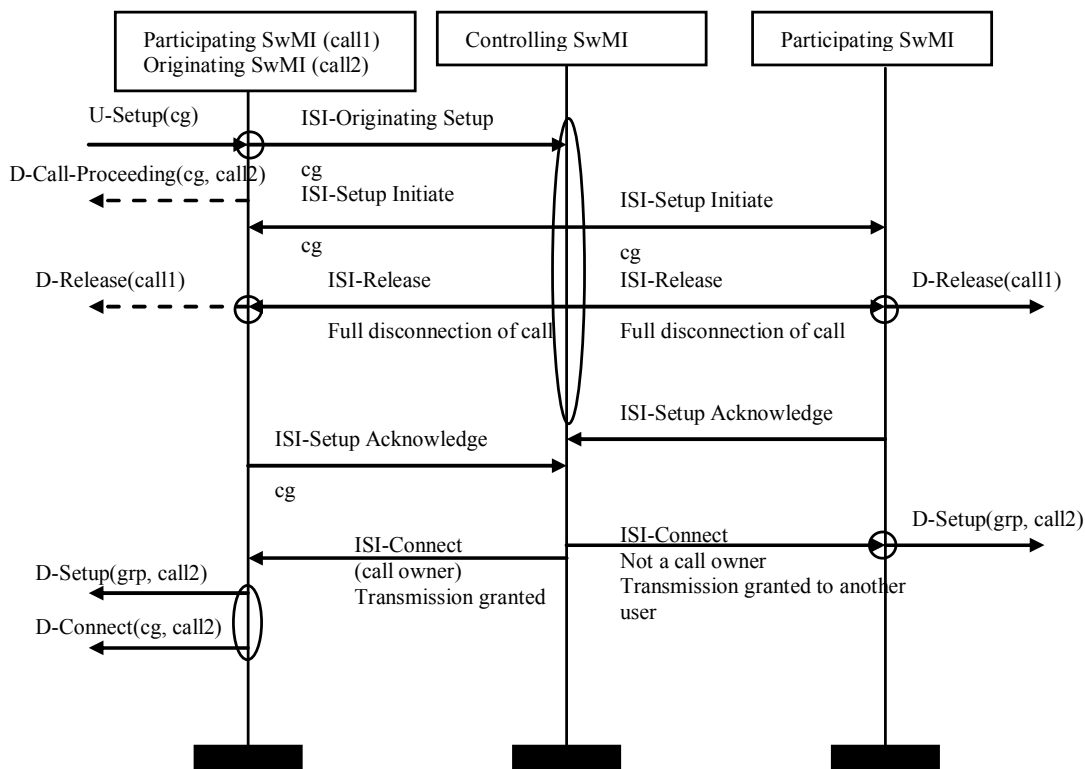

NOTE 1: The PSwMIs, CSwMI are already in a group call (call1) that is called by the party at the OSwMI at an emergency priority.

NOTE 2: The CSwMI attempts to set up the new call and clear down the existing call. The OSwMI may, optionally, already have cleared the original call locally, before being prompted to do so by the CSwMI.

NOTE 3: Each of the calls uses a different transport connection.

NOTE 4: The order of ISI-SETUP INITIATE and ISI-RELEASE sent from the CSwMI is implementation dependent.

Figure C.17: An emergency priority call to a group that is already active in a call

Description

On receiving an ISI-ORIGINATING-SETUP PDU, at an emergency priority, for a group call that is already connected, at a non-emergency priority, the CSwMI clears down the existing call while setting up the new one.

C.1.19 A call collision at startup

Refer to figure C.18.

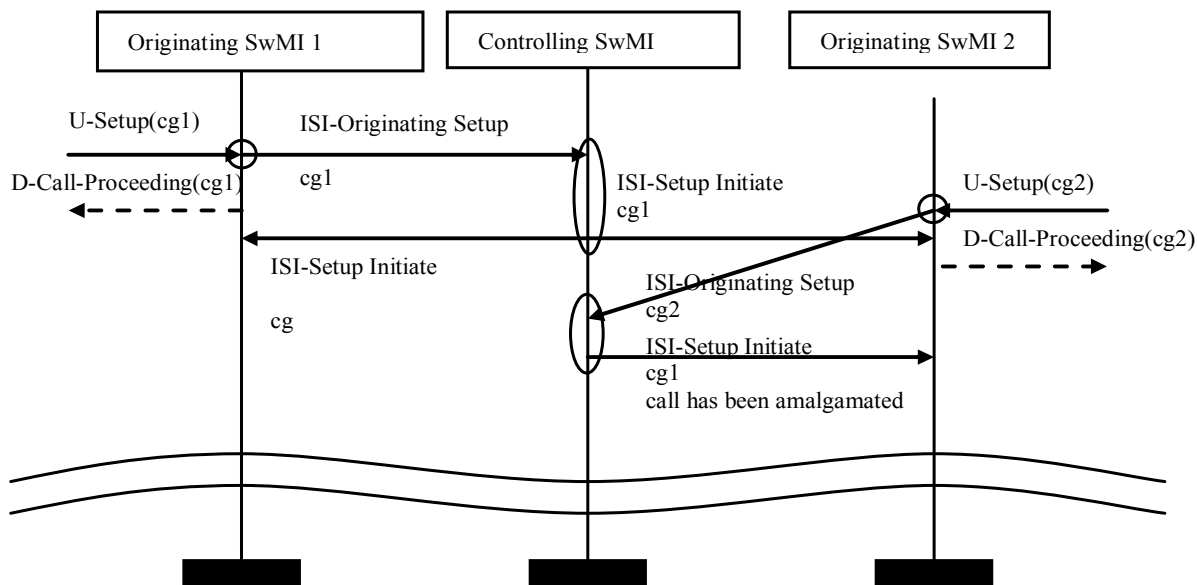

- NOTE 1: If the CSwMI receives an ISI-ORIGINATING-SETUP PDU just after it has sent an ISI-SETUP-INITIATE PDU to the same SwMI, for the same call, then it will respond with an ISI-SETUP-INITIATE PDU with the "amalgamation" information element set to "call has been amalgamated". Two transport connections will have to be used in this case and each of the ISI-SETUP-INITIATE PDU will have been sent down separate transport connections.
- NOTE 2: Two ANF instances for the same call will be active in OSwMI 2. The receipt of the second ISI-SETUP-INITIATE PDU, with the "call amalgamation" field set, to the instance of the calling party, causes it to search for, and merge with the other ANF instance. Only the transport connection of the first ISI-SETUP-INITIATE PDU is now used for the call and the second transport connection is cleared down by the CSwMI when the ISI-SETUP-INITIATE PDU was sent.
- NOTE 3: The call then proceeds in the normal way, with two OSwMIs.

Figure C.18: A call collision at startup

Description

A call continues when two parties attempt to setup the same call at the same time.

C.1.20 Partial successful group call establishment, call is not accepted by a PSwMI

- CSwMI connects when an OSwMI is ready. Refer to figure C.19.

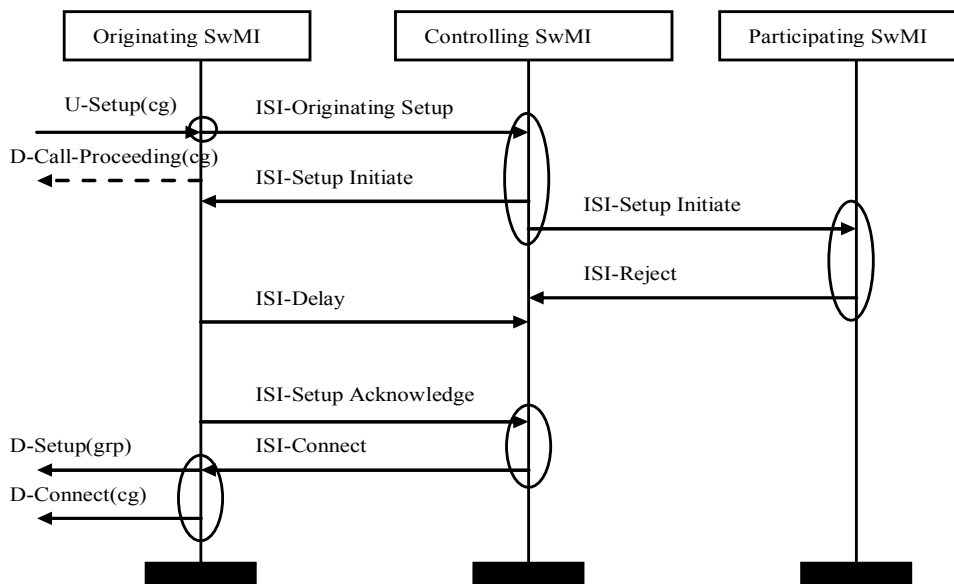

NOTE 1: A group call can continue if any PSwMI that should be part of the call declines to be part of it.

NOTE 2: The group call may be released by the CSwMI if the CSwMI determines that the removal of the SwMI from the call results in no called group members being in the call.

Figure C.19: Partial successful group call setup, Call is not accepted by a PSwMI

Description

If an ISI-REJECT PDU is received in response to an ISI-SETUP-INITIATE PDU sent to a PSwMI then the CSwMI will remove the rejecting SwMI from the SwMIs in the group call.

C.1.21 Unsuccessful group call establishment rejected by an OSwMI

Refer to figure C.20.

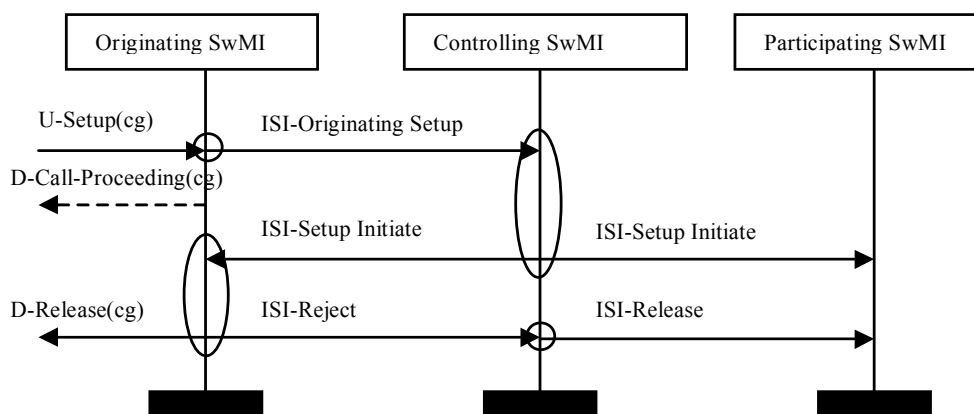

NOTE 1: A group call does not continue without an OSwMI (unless the OSwMI is also the CSwMI).

NOTE 2: The CSwMI may have already been notified that there is another OSwMI, via an ISI-ORIGINATING-SETUP PDU. If the CSwMI supports multiple calling parties then, when the ISI-REJECT PDU is received, the call is allowed to continue since it is being initiated by another SwMI located elsewhere. In this case the other SwMIs in the call are NOT sent an ISI-RELEASE PDU.

Figure C.20: Unsuccessful group call establishment, rejected by an OSwMI

Description

If an ISI-REJECT PDU is received from the OSwMI that has previously received an ISI-SETUP-INITIATE PDU and there are no other calling parties then the group call cannot continue. All remaining SwMIs are released from the group call by being sent an ISI-RELEASE PDU.

C.1.22 Unsuccessful group call establishment, the CSwMI cannot accept some parameters, such as *resource allocation*, in the ISI SETUP ACKNOWLEDGE PDU from an OSwMI

Refer to figure C.21.

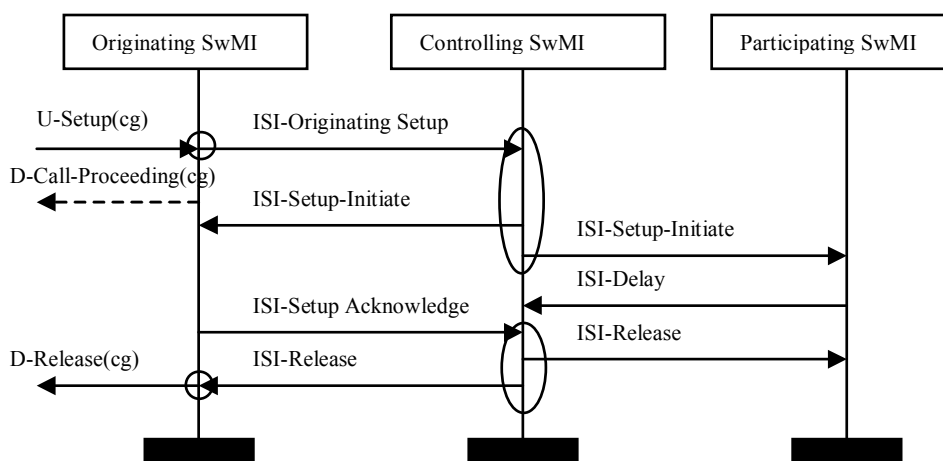

NOTE 1: In the case of a OSwMI that sends incompatible arguments, the CSwMI may release the PSwMI from the call, but allow the call to continue. The call continues, provided that the CSwMI does not determine that there are no group members in the call.

NOTE 2: If the call has other OSwMIs (the CSwMI has received at least one other ISI-ORIGINATING-SETUP PDU) when the ISI-SETUP-ACKNOWLEDGE PDU arrives, then there is no need for the CSwMI to release the whole call. Only the SwMI sending the incompatible ISI-SETUP-ACKNOWLEDGE PDU needs to be released.

Figure C.21: Unsuccessful group call establishment, the CSwMI cannot accept some parameters in the ISI SETUP ACKNOWLEDGE PDU from an OSwMI

Description

If a SwMI that hosts a calling party requests a communication type that is different from *point-to-multipoint*, or a resource allocation policy that it does not support, in its **ISI-SETUP-ACKNOWLEDGE** PDU then the call may be cleared by the **CSwMI**. This is achieved by sending an **ISI-RELEASE** PDU to all SwMIs.

C.1.23 Unsuccessful Group Call Establishment, OSwMI or Party times out

Refer to figure C.22.

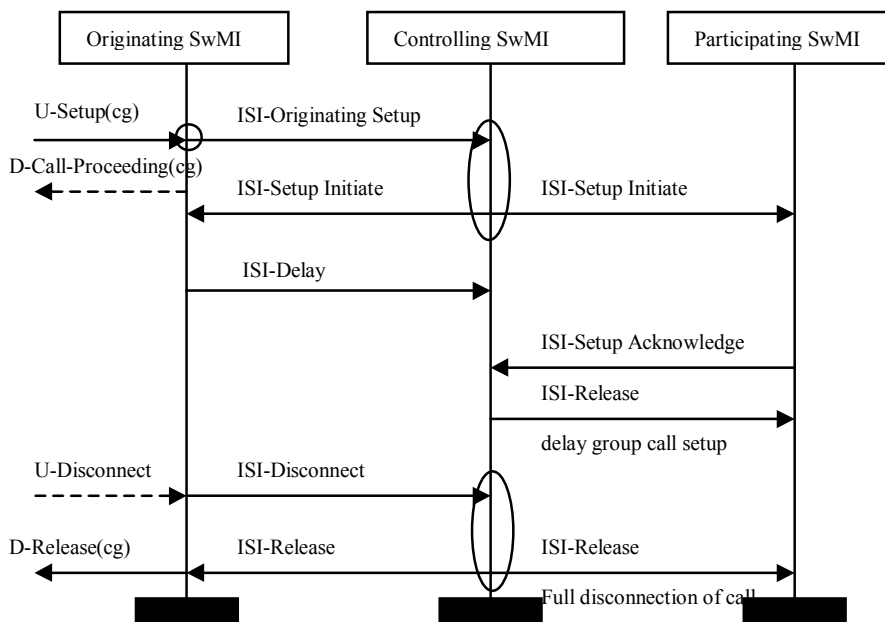

NOTE 1: If the call setup timer is exceeded before the call is successfully set up, then the OSwMI will disconnect the call.

NOTE 2: The OSwMI will indicate whether the call is clearing in the SwMI by disconnecting, or not disconnecting, the underlying transport connection. The CSwMI will send an ISI-RELEASE PDU to the OSwMI, to release the SwMI from the call, if the underlying transport connection was disconnected. If there are no other OSwMIs all SwMIs, including the OSwMI, are released from the call and the transport connection disconnected.

Figure C.22: Unsuccessful group call establishment, OSwMI or owing Mobile times out

Description

An ISI-DISCONNECT PDU sent from an OSwMI during the group call setup phase may cause the call to be cleared. This is achieved by sending an ISI-RELEASE PDU to all SwMIs in the call.

C.1.24 Unsuccessful group call establishment rejected by the CSwMI

Refer to figure C.23.

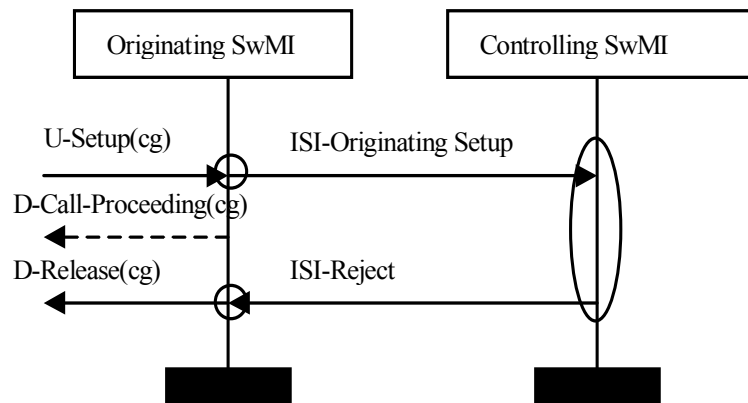

Figure C.23: Unsuccessful group call establishment, rejected by the CSwMI

Description

An ISI-REJECT PDU is sent in response to an ISI-ORIGINATING-SETUP PDU that cannot be accepted by the CSwMI.

C.2 Call maintenance

NOTE: For the present version of the present document only a permanently allocated resource policy is supported. The information element "Resource allocation" is always set to "Permanently allocated resources".

Refer to figure C.24.

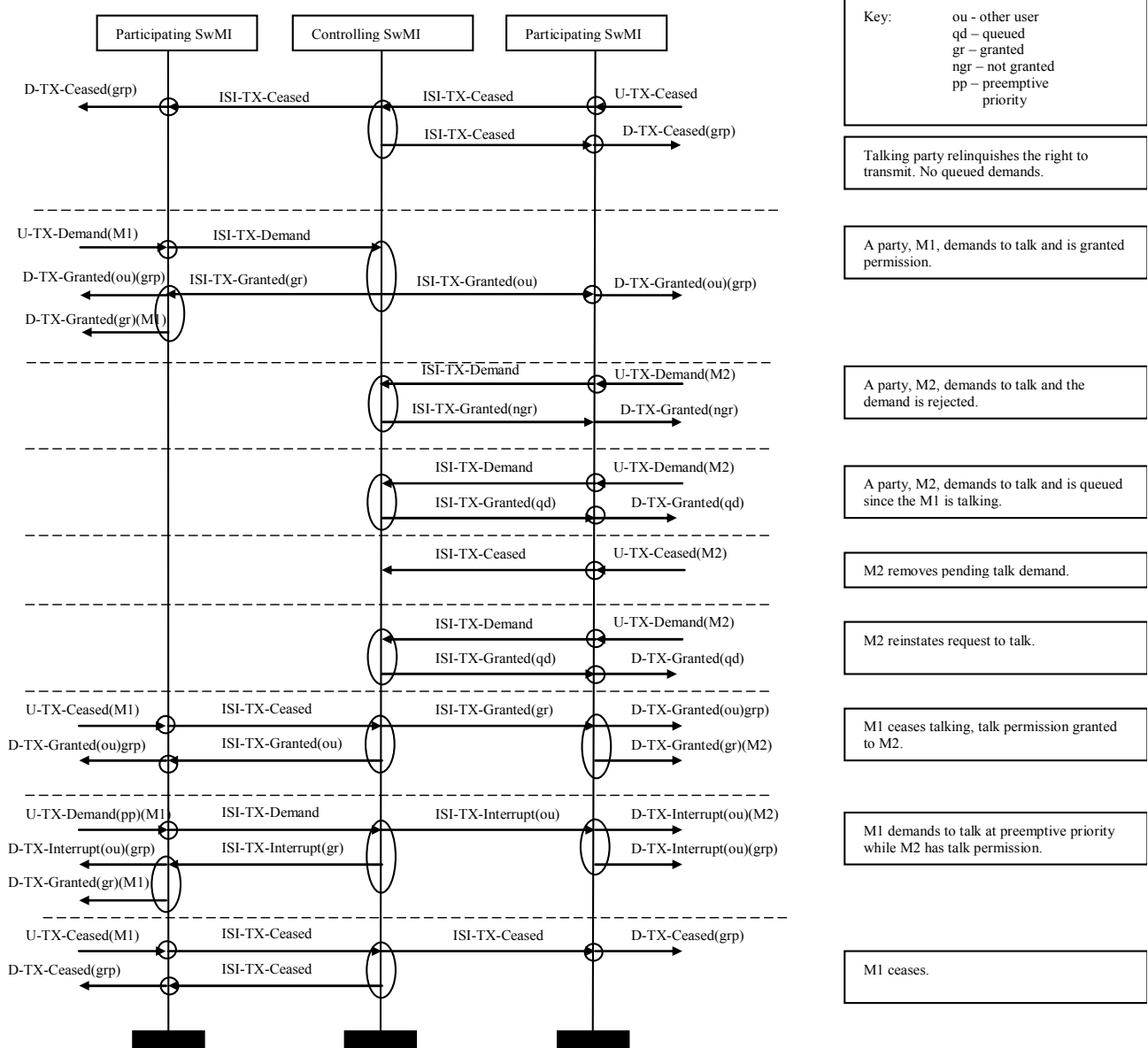

Figure C.24: Call maintenance

NOTE 1: There could be one or more PSwMIs.

NOTE 2: There will be no air interface signalling at the CSwMI if there are no group members present there.

NOTE 3: When an ISI-TX INTERRUPT (gr) PDU is received a SwMI sends both an air interface D-TX INTERRUPT (ou) PDU to the group and a D-TX GRANTED (gr) PDU to the granted party. Also note 5 applies.

NOTE 4: When an ISI-TX INTERRUPT PDU is received a SwMI sends an air interface D-TX INTERRUPT (ou) PDU to the previous talking party, if the party was present at the SwMI, prior to sending a D-TX INTERRUPT (ou) PDU to the group. In the case of an ISI-TX INTERRUPT (gr) PDU this could result in up to three air interface PDUs being sent as the result of a single ISI PDU.

NOTE 5: When an ISI-TX GRANTED (gr) PDU is received, the receiving SwMI sends an air interface D-TX GRANTED (gr) PDU to the party receiving transmit permission and a D-TX GRANTED (ou) PDU to the group address of any other group members.

NOTE 6: ISI-TX WAIT and ISI-TX CONTINUE PDUs will be supported in future releases only.

Description

When the current talking party relinquishes talk permission an ISI-TX CEASED PDU is sent to the CSwMI. If the CSwMI ascertains that no other Group Member has requested transmit permission it informs both the original talking parties SwMI, and all other PSwMIs that there is now no talking party in the call via an ISI-TX CEASED PDU. If the CSwMI determined that there was another party requiring transmit permission then an ISI-TX GRANTED (gr) PDU is sent to the PSwMI of the granted party and an ISI-TX GRANTED (ou) PDU to all other PSwMIs.

A request is sent to the CSwMI for transmit privilege for a party using an ISI-TX DEMAND PDU. If the CSwMI ascertains that no other Group Member has transmit permission it is granted to the requesting user's SwMI via an ISI-TX GRANTED (gr) PDU. In addition, in order that all other Group Members may be informed that the call now has a talking party, all other Participating SwMIs are sent an ISI-TX GRANTED (ou) PDU. If the transmit request queue at the CSwMI is full, the CSwMI may reject the demand. If the CSwMI ascertains that a current group member has transmit permission, and the demand is not at a pre-emptive priority, then the CSwMI may queue the demand. To indicate that this has happened an ISI-TX GRANTED (qd) PDU is sent to the demanding SwMI.

An ISI-TX CEASED PDU is used by a non-talking party whose intention is to remove a queued demand. In this case the CSwMI does not respond to the ceasing SwMI.

When a demand to transmit is received at pre-emptive priority the CSwMI indicates that the demanding SwMI is granted transmit permission via an ISI-TX INTERRUPT (gr) PDU. In order that all other SwMIs can be told that the call has a new talker an ISI-TX INTERRUPT (ou) PDU is sent to the other SwMIs.

C.3 Call termination

C.3.1 The release of a SwMI from a call

Refer to figure C.25.

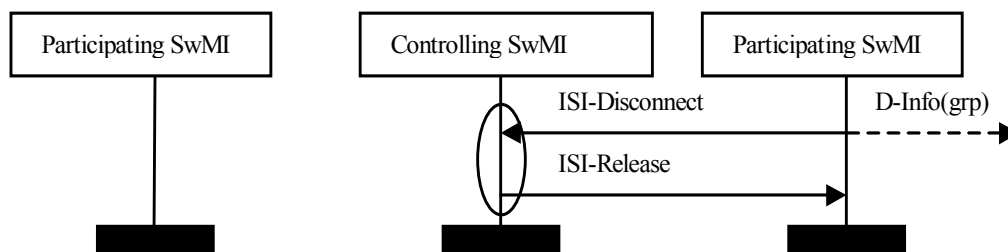

NOTE 1: The call may be cleared if the CSwMI can determine that the withdrawal of a SwMI results in there being no group members in the call.

NOTE 2: The ISI-DISCONNECT PDU may be sent in a transport connection terminating message or a transport preserving message. In the transport termination case the PSwMI is no longer in the call and the CSwMI will automatically respond with ISI-RELEASE PDU. In the transport preserving case the CSwMI decides if the PSwMI is to remain in the call, it therefore may, or may not, respond with the ISI-RELEASE PDU.

Figure C.25: The release of a PSwMI from an ongoing call

Description

The CSwMI may continue with a call where one of the PSwMIs drops out of the call.

C.3.2 Call disconnection, as a result of a PSwMI disconnecting

Refer to figure C.26.

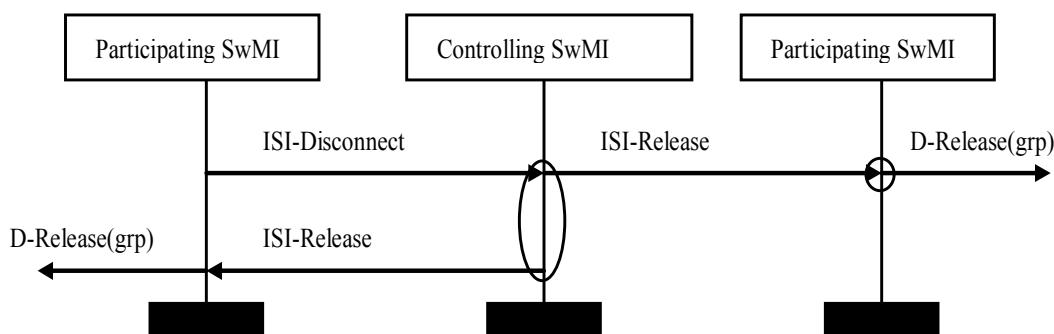

NOTE: The ISI-DISCONNECT PDU may be sent in either a transport connection terminating message or a transport preserving message.

Figure C.26: Call Disconnected

Description

The CSwMI may decide to clear a call when a PSwMI withdraws from it.

C.3.3 Call disconnection by the CSwMI

Refer to figure C.27.

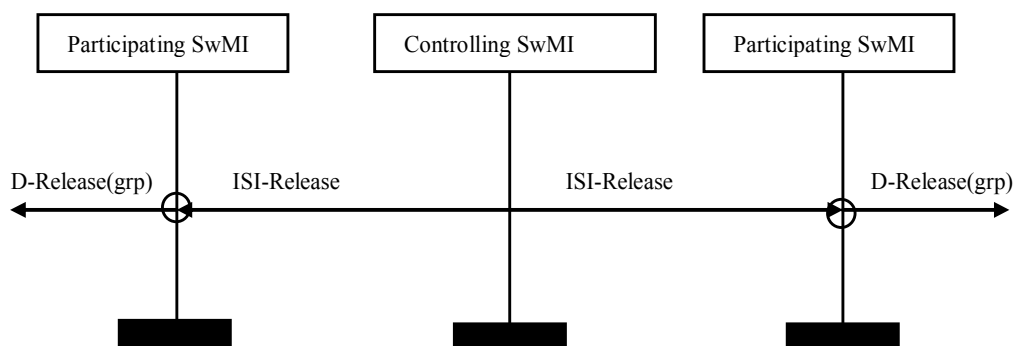

NOTE: This is the usual way for a call to be released if it is a call with a short hang time.

Figure C.27: Call Disconnected by the CSwMI

Description

The CSwMI has the right to close down a group call if needed. To do this it sends ISI-RELEASE PDU to all SwMIs in the call.

Annex D (informative): Bibliography

- ETSI TR 102 300-5: "Terrestrial Trunked Radio (TETRA); Voice plus Data (V+D); Designers' guide; Part 5: Guidance on numbering and addressing".
- ETSI EN 300 172: "Private Integrated Services Network (PISN); Inter-exchange signalling protocol; Circuit-mode basic services [ISO/IEC 11572 (2000) modified]".

Annex E (informative): Change Requests

The present document includes change requests as presented in table E.1.

Table E.1: Change Requests

No	CR vers.	Standard Version	Clauses affected	Title	CR Status

History

Document history		
V1.1.1	May 2018	Publication